

**SHIPPING ACT**

**CHAPTER 50:10**

**Act**  
**24 of 1987**  
Amended by  
144/1993\*  
3 of 2007

\*See Note on page 3

**Current Authorised Pages**

<i>Pages (inclusive)</i>	<i>Authorised by L.R.O.</i>
1-2	..
3-18	..
19-20	..
21-222	..
223-224	..
225-256	..
257-260	..
261-302	..
303-304	..
305-808	..
809-945	..

## LAWS OF TRINIDAD AND TOBAGO

MINISTRY OF THE ATTORNEY GENERAL AND LEGAL AFFAIRS

www.legalaffairs.gov.tt

2

**Chap. 50:10**

*Shipping*

### Index of Subsidiary Legislation

	<i>Page</i>
Shipping (Registration of Ships) Regulations (LN 223/1987) ... ..	223
Shipping (Tonnage) Regulations (LN 147/1988) ... ..	303
Shipping (Navigational Aids Dues) (No. 2) Regulations (LN 221/1989) ...	367
Shipping (Seamen's Discharge Book Fees) Regulations (LN 225/1990) ...	373
Shipping (Distress Signals and Prevention of Collisions) Regulations (LN 242/1990) ... ..	374
Shipping (Local Passenger Ship) (Safety) Regulations (LN 51/1991) ...	413
Shipping (Medical Examination) Regulations (LN 2/1991) ... ..	421
Shipping (Load Line) Regulations (LN 3/1993) ... ..	459
Shipping (Load Lines) (Exemption) Order (LN 23/1993) ... ..	619
Shipping (Load Lines) (Deck Cargo) Regulations (LN 24/1993) ... ..	621
Shipping (Certification of Seamen) (Deck Ratings) Regulations (LN 142/1993) ... ..	631
Shipping (Provisions and Water) Regulations (LN 144/1993) ... ..	661
Shipping (Passenger Ferry) Regulations (LN 238/1994) ... ..	666
Shipping (Safety of Navigation) (Chaguaramas Bay) Regulations (LN 35/1995) ... ..	675
Shipping (Certification of Seamen) (Engineering Ratings) Regulations (LN 135/1995) ... ..	676
Shipping (Crew Accommodation) Regulations (LN 94/1996) ... ..	703
Shipping (Training, Certification, Safe Manning, Hours of Work and Watchkeeping) Regulations (LN 81/2002) ... ..	809
Shipping (Ship and Port Facility Security) Regulations (131/2004) ... ..	885
Shipping (Small Commercial Vessels) Regulations (LN 13/2008) ... ..	921

#### **Note on Section 73 of the Act**

For the preservation of existing laws of Maritime Liens *see* Section 73 of this Act.

#### **Note on Part XXV**

With respect to PART XXV—(Final and Transitional Provisions) preserving existing Admiralty Jurisdiction of the High Court and existing written laws. *See* the 2004 Edition of the Consolidated Index of Acts and Subsidiary Legislation for references.

UNOFFICIAL VERSION

UPDATED TO 31ST DECEMBER 2016

**Note on Transfer of Functions**

*See* the following Legal Notices for transfer of functions:

1. LNs 224/1987 and 49/1988—From Registrar of Ships to Harbour Master and Superintendent of Lighthouses.
2. LNs 112/1988 and 122/1988— From Director of Marine Services to Harbour Master and Superintendent of Lighthouses.
3. LN 227/1990 — From Minister of Works, Infrastructure, etc., to Deputy Director of Maritime Services.

**Note on LN 144/1993**

*See* Note to section 317(2) and 387(2) to (4) of the Act.

**CHAPTER 50:10**

**SHIPPING ACT**

ARRANGEMENT OF SECTIONS

**SECTION**

1. Short title.

**PART I**

**PRELIMINARY**

2. Interpretation.

**PART II**

**RESTRICTION ON TRADING**

3. Restriction on trading in Trinidad and Tobago.

**PART III**

**REGISTRATION AND LICENSING OF SHIPS**

**REGISTRATION**

4. Qualifications for owning Trinidad and Tobago ships.
5. Obligations to register Trinidad and Tobago ships.
6. Registrar of ships and Deputy Registrar.
7. Application for registration.
8. Declaration of ownership on registration and other evidence required.
9. Evidence on first registry.
10. Restrictions on registration.
11. Cancellation of registration.
12. Restriction on deregistration of ships.
13. Port of Registry.
14. Register books.
15. Registration of merchant ships.
16. Name of ship.
17. Change of name of ship.
18. Register book for fishing vessels.
19. Offences.
20. Call sign.
21. Register book for ships under construction.
22. Surveys and measurement of ships.
23. Tonnage once ascertained to be tonnage of ship.
24. Tonnage of foreign ship.

UNOFFICIAL VERSION

UPDATED TO 31ST DECEMBER 2016

**SECTION**

25. Foreign and other measurements.
26. Alterations between surveys.
27. Appointment of surveyors.
28. Marking of ships.

**CERTIFICATE OF REGISTRY**

29. Issue and custody of Certificate of Registry.
30. Use of improper certificate.
31. Power to make Regulations in relation to Certificate of Registry.
32. Provisional Certificate of Registry.
33. Temporary pass in lieu of Certificate of Registry.

**REGISTRATION OF ALTERATIONS AND REGISTRATION ANEW**

34. Registration of alteration.
35. Alterations noted on Certificate of Registry.
36. Provisional certificate where ship registered anew.
37. Registration anew on change of ownership.
38. Procedure for registration anew.
39. Restriction on re-registration of wrecked or abandoned ships.

**LICENSING**

40. Ships to be licensed.
41. Qualifications for owning Trinidad and Tobago ships.
42. Operating restrictions.
43. Regulations.

**PART IV**

**NATIONAL CHARACTER AND FLAG**

44. National character of ship to be declared before clearance.
45. Right to fly flag of Trinidad and Tobago.
46. Nationality and colours.
47. Penalty for unduly assuming Trinidad and Tobago character.
48. National flag on foreign ship.
49. Penalty for concealment of Trinidad and Tobago character.
50. Penalty for acquiring ownership if not qualified.
51. Liabilities of ship not recognised as Trinidad and Tobago ship.

ARRANGEMENT OF SECTIONS—*Continued*

SECTION

PART V

**TRANSFERS AND TRANSMISSIONS, MORTGAGES  
AND MARITIME LIENS**

**TRANSFERS AND TRANSMISSIONS**

52. Transfers by Bill of Sale.
53. Declaration of transfer.
54. Bill of Sale to be produced to Registrar for entry in Register.
55. Transmission of property in ship on death, bankruptcy, etc.
56. Order of sale on transmission to unqualified person.
57. Transfer of sale of ship by order of Court.
58. Court may prohibit any dealing with ship.

**MORTGAGES**

59. Method of mortgage of ship or share.
60. Entry of discharge of mortgage.
61. Priority of mortgages.
62. Mortgagee not treated as owner.
63. Mortgagee to have power of sale.
64. Transfer of mortgage.
65. Transmission of interest in mortgage by death, bankruptcy.
66. Authority to sell or mortgage out of Trinidad and Tobago.
67. General rules for Certificates of Sale.
68. Procedure where ship under Certificate of Sale granted in Trinidad and Tobago.
69. Registry in Trinidad and Tobago where ship sold under Certificate of Sale granted in a foreign State.
70. Rules as to certificates of mortgage.
71. Loss of Certificate of Sale or mortgage.
72. Revocation of Certificate of Sale or mortgage.

**MARITIME LIENS**

73. Application of law and equity.

PART VI

**MISCELLANEOUS**

74. Provision for cases of infancy and other disability.
75. Notice of trusts net received.
76. Equities net excluded by Act.

**SECTION**

- 77. Liability of owners.
- 78. Managing owner to be registered.
- 79. Power of Registrar to dispense with declarations and other evidence.
- 80. Mode of making declarations.
- 81. Admissibility of register as evidence.
- 82. Forms.
- 83. Instructions to Registrar.
- 84. Forgery of documents.
- 85. False declarations.
- 86. Proceedings on forfeiture of ship.

**PART VII**

**MANNING AND CERTIFICATION**

- 87. Minister to make Regulations for examinations for certification of competency.
- 88. Power to exempt.
- 89. Recognition of certificates issued abroad.
- 90. Power of the Minister to suspend or cancel.
- 91. Uncertified and unauthorised officers.
- 92. Production of certificates and other documents of qualification.
- 93. Offences relating to certificate.
- 94. Prohibition against going to sea unmanned.
- 95. Ship leaving without clearance.

**PART VIII**

**ENGAGEMENT OF SEAMEN**

- 96. Registrar of Seamen.
- 97. Functions.
- 98. Crew agreements.
- 99. Contents of crew agreement.
- 100. Regulations for disciplinary offences.
- 101. Same offence.
- 102. Procedures relating to certain crew agreements.
- 103. Further provisions as to crew agreement.
- 104. Stipulations adopted by the parties not to be contrary to law of flag State.
- 105. Certificate of discharge of seamen.

ARRANGEMENT OF SECTIONS—*Continued*

**SECTION**

- 106. Character report.
- 107. Discharge on change of registration.
- 108. Employment of children and young persons.
- 109. Changes in crew of certain ships.
- 110. Change of master.
- 111. Conditions of service—power of Minister to make Regulations.
- 112. Use of English language.
- 113. Crew’s knowledge of English.
- 114. Time and manner of payment.
- 115. Master to deliver account of wages.
- 116. Deductions.
- 117. Settlement of wages.
- 118. Registrar’s decision as to wages.
- 119. Registrar may require ship’s papers.
- 120. Rate of exchange.
- 121. Power of Registrar of Seamen or proper officer to decide disputes about wages.
- 122. Power of Court to award interest on wages due otherwise than under crew agreement.
- 123. Allotment notes.
- 124. Wages where service terminated.
- 125. Protection of certain rights and remedies.
- 126. Claims against seaman’s wages for maintenance.
- 127. Remedies of master for remuneration and disbursements.
- 128. Wages not to depend on freight.
- 129. Refusal to work.
- 130. Illness caused by own default.
- 131. Costs of procuring conviction.
- 132. Improper discharge.
- 133. Protection of wages.

**ANNUAL LEAVE AND PUBLIC HOLIDAYS**

- 134. Leave and holidays.

**MODE OF RECOVERING WAGES**

- 135. Seaman may sue for wages.
- 136. Jurisdiction of High Court limited.
- 137. Power to rescind contracts.

**SECTION**

**PROPERTY OF DECEASED SEAMAN**

- 138. Property of deceased seaman.
- 139. Delivery of the property.
- 140. Forgery of document.

**OCCUPATIONAL SAFETY, PROVISIONS, HEALTH AND WELFARE**

- 141. Occupational safety Regulations.
- 142. Provisions and water.
- 143. Complaint as to provisions or water.
- 144. Allowance for short or bad provisions.
- 145. Weights and measures.
- 146. Medical examinations and cooking.
- 147. Crew accommodation.
- 148. Certified cook.
- 149. Scales of medical stores.
- 150. Expenses of medical treatment and burial.
- 151. Medical practitioners to be carried.
- 152. Welfare of seaman.
- 153. Facilities for making complaints.

**PROTECTION OF SEAMEN FROM IMPOSITION**

- 154. Assignment and sale of salvage.
- 155. Seamen's debts.

**PROVISIONS AS TO DISCIPLINE**

- 156. Endangering life or ship.
- 157. General offences against discipline.
- 158. Conviction not to affect other remedies.
- 159. Improper negotiation of advance note.
- 160. Certificate of discharge may be withheld.
- 161. False statement as to last ship or name.
- 162. Deserter from foreign ships.
- 163. Proof of desertion in proceedings for forfeiture of wages.
- 164. Application of forfeiture.
- 165. Question of forfeiture decided in suit for wages.
- 166. Deduction of fine from wages.
- 167. Persuading seaman to desert, and harbouring deserter.
- 168. Penalty on stowaways.

ARRANGEMENT OF SECTIONS—*Continued*

**SECTION**

- 169. Trade disputes involving seamen.
- 170. Offences to be entered in official log book.

**RELIEF AND REPATRIATION**

- 171. Repatriation of seaman.
- 172. Exception from liability.
- 173. Duty of Registrar.
- 174. Effect of workman's compensation.
- 175. Application to foreign vessels.
- 176. Wages and effects of seaman left behind.
- 177. Liability of master.
- 178. Liability of Government.
- 179. Payment to Government.
- 180. Non-application of section 176.
- 181. Effects of seaman.
- 182. Return from service.
- 183. Discharge on ownership change.
- 184. Certificate when seaman left.
- 185. Offence.
- 186. Account of wages.
- 187. Payment of wages.
- 188. Application of wages.
- 189. Relief of distressed seaman.
- 190. Repayment of relief and return.
- 191. Forcing ashore.
- 192. Proper return port.
- 193. Manner of return.
- 194. Return of seaman.
- 195. Assistance by Minister.

**PART IX**

**OFFICIAL LOG BOOK AND ORDINARY SHIP'S LOG**

- 196. Official log book.
- 197. Entries in official log book.
- 198. Copy of official log book.
- 199. Delivery of official log book to Director in case of transfer of ownership of a ship.

UNOFFICIAL VERSION

UPDATED TO 31ST DECEMBER 2016

**SECTION**

- 200. Offences in respect of log book.
- 201. Ordinary ship's log.
- 202. Returns of crew of ship.
- 203. Returns of births and deaths.

**PART X**

**SAFETY PRECAUTIONS AND NAVIGATIONAL SAFETY**

- 204. Collision Regulations.
- 205. Presumption of fault.
- 206. Inspection of ships to enforce compliance with Collision Regulations.
- 207. Duty of ship to assist in case of collision.
- 208. Record of boat drill or fire drill to be kept in official log book.
- 209. Crew sufficient and efficient.
- 210. Obligation to notify hazards of navigation.
- 211. Notices to Mariners and Navigational Warnings.
- 212. Master to proceed moderately in danger area.
- 213. Obligation to assist vessels in distress.
- 214. Signals of distress.
- 215. Report of accident and loss of ship.
- 216. Apprehended loss of ship.

**NAVIGATIONAL AIDS**

- 217. Interpretation.
- 218. Establishment and management.
- 219. Minister's permission to establish navigational aids.
- 220. Functions of the Director.
- 221. Offence.
- 222. Detention.
- 223. Power of the Director on failure to extinguish false or unauthorised lights, etc.
- 224. Penalty for failure to pay navigational aid dues.
- 225. Regulations.

**PART XI**

**APPLICATION OF THE CONVENTION FOR THE  
SAFETY OF LIFE AT SEA**

- 226. Interpretation.
- 227. States to which Safety Convention applies.

ARRANGEMENT OF SECTIONS—*Continued*

## SECTION

- 228. Application of Safety Convention Regulations.
- 229. Regulations to enforce the Safety Convention.
- 230. Breach of Safety Regulations.
- 231. Appointment of surveyors.
- 232. Surveyor's powers of inspection.
- 233. Surveyor's report for Director.
- 234. Record of inspections and certificates.
- 235. Survey of passenger ships.
- 236. Initial survey.
- 237. Periodic surveys.
- 238. Additional surveys.
- 239. Issue of Safety Certificate to passenger ships.
- 240. Short Voyage Certificate.
- 241. Exemption Certificate and Qualified Certificate.
- 242. Validity of Short Voyage Certificates for passenger ships.
- 243. Passenger Safety Certificate to be carried on board.
- 244. Penalty for carrying excess passengers.
- 245. Surveys of life-saving appliances and other equipment of cargo ships.
- 246. Issue of Safety Equipment Certificate for cargo ships.
- 247. Exemption Certificate and Qualified Safety Equipment Certificate.
- 248. Surveys of radar and radio installations on cargo ships.
- 249. Issue of Radio Certificate.
- 250. Exemption Certificate and Qualified Radio Certificate.
- 251. Radio Exemption Certificate.
- 252. Surveys of hull, machinery and equipment of cargo ships.
- 253. Cargo Ship Construction and Survey Regulations.
- 254. Issue of Cargo Ship Safety Construction Certificate.
- 255. Exemption Certificate and Qualified Cargo Ship Safety Construction Certificate.
- 256. Validity period of Cargo Ship Safety Construction Certificate.
- 257. Appeals against withholding of certificates or detention of ship.
- 258. Duration of certificates.
- 259. Extension of validity of certificates.

**SECTION**

- 260. Validity of qualified certificates.
- 261. Penalty for non-compliance with conditions of exemption certificates.
- 262. Posting of certificates.
- 263. Survey of ship in respect of which an accepted Safety Certificate is issued.
- 264. Production of Safety Convention Certificate.
- 265. Miscellaneous privileges of ships holding Safety Convention Certificates.
- 266. Prohibition on proceeding to sea without appropriate certificate.
- 267. Detention of ship for lack of production of certificates.
- 268. Ship's stability.
- 269. Penalty for forgery of certificate of declaration.
- 270. Notice of alterations affecting the efficiency or seaworthiness of the ship.
- 271. Renewal of survey of ship ordered by the Director at any time.
- 272. Application of this Part to foreign ships—exemption from compliance with this Part.
- 273. Issue of accepted Safety Convention Certificates by the Minister in respect of foreign registered ships.
- 274. Issue of certificates by other Governments.
- 275. Exceptions.
- 276. Regulations for safety requirements and issue of local safety certificates.

**PART XII**

**LOAD LINES**

- 277. Interpretation.
- 278. Exceptions.
- 279. States to which Load Line Convention applies.
- 280. Minister to make Load Line Regulations to give effect to the Load Line Convention.
- 281. Certificates which can be issued under the Load Line Convention.
- 282. Issue of Load Line Certificates.
- 283. Certificates issued by other Governments.
- 284. Certificates issued by the Government of Trinidad and Tobago at the request of other Governments.

ARRANGEMENT OF SECTIONS—*Continued*

**SECTION**

- 285. Validity of foreign certificates.
- 286. Power to make exemption orders.
- 287. Further powers to exempt the ship.
- 288. Extent of exemption.
- 289. Issue of exemption certificates.
- 290. Duration and determination of exemptions, etc.
- 291. Effect of Load Line Certificates.
- 292. Duration, renewal and cancellation of Load Line Certificate.
- 293. Ships not to proceed to sea without Load Line Certificate.
- 294. Deck cargo.
- 295. Inspection of Trinidad and Tobago load line ships.
- 296. Alterations of the ship affecting the position of load lines.
- 297. Submersion of load lines.
- 298. Alteration or defacement of marks.
- 299. Ships not to proceed to sea unless complying with Load Line Regulations.
- 300. Production of certificates to Customs.
- 301. Production of Load Line Certificate for foreign ships.
- 302. Applicability of rules as to submersion of load lines to foreign ships.
- 303. Publication and display of Load Line Certificate and entry into log book of particulars of load lines.
- 304. Inspection of ships.
- 305. Contravention of Load Line Regulations and detention of ship.

**PART XIII**

**CARRIAGE OF BULK CARGOES**

- 306. Minister may make Regulations.
- 307. Grain cargoes.
- 308. Offence.

**PART XIV**

**DANGEROUS GOODS**

- 309. Regulations as to dangerous goods.
- 310. Carriage of dangerous goods.
- 311. Offence.

**SECTION**

- 312. Disposing of dangerous goods.
- 313. Forfeiture of dangerous goods.

**PART XV**

**SEAWORTHINESS OF SHIPS**

- 314. Sending unseaworthy ship to sea.
- 315. Duty to ensure seaworthiness.
- 316. Detention of unseaworthy ship.
- 317. Liability for costs, damages.
- 318. Complainant liability.
- 319. Security for costs.

**PART XVI**

**WRECKS AND SALVAGE**

- 320. Power of Principal Receiver of Wreck and designation of receivers.
- 321. Fees of receiver of wreck.
- 322. Vessels in receiver of wreck.
- 323. Power of receiver of wreck.
- 324. Power to pass over adjoining lands.
- 325. Immunity of receiver.
- 326. Obstruction of receiver.
- 327. Duties of persons finding wreck.
- 328. Notice of wreck.
- 329. Claims of owners to wreck.
- 330. Sale of wreck in certain cases.
- 331. Unclaimed wreck.
- 332. Sale of unclaimed wreck.
- 333. Discharge of receiver.
- 334. Removal of wreck being a hindrance to navigation.
- 335. Breaking up and removing wreck.
- 336. Extent of power of removal.
- 337. Offences related to wreck.
- 338. Unauthorised boarding of wreck.
- 339. Interfering with wreck.
- 340. Summary procedure for concealment of wreck.
- 341. Taking wreck at the time of casualty.

ARRANGEMENT OF SECTIONS—*Continued*

**SECTION**

- 342. Salvage payable for saving life.
- 343. Salvage of vessel, cargo or wreck.
- 344. Exclusion of remuneration.
- 345. Determination of salvage disputes.
- 346. Rescission of salvage agreements.
- 347. Valuation of property.
- 348. Detention of property liable to salvage.
- 349. Sale of detained property.
- 350. Apportionment of salvage in relation to foreign vessel.
- 351. Apportionment of salvage by receiver.
- 352. Apportionment by the High Court.
- 353. Salvage services rendered by State.
- 354. Time limit for salvage proceedings.
- 355. Provisions as to duties on wrecked goods.

**PART XVII**

**PASSENGER SHIPS**

- 356. Power of the Minister to make Regulations respecting passenger ships.
- 357. Offences in connection with passenger ships.

**PART XVIII**

**LIMITATION AND DIVISION OF LIABILITY**

- 358. Interpretation.
- 359. Limitation of liability of shipowners.
- 360. Power of the Court to consolidate claims.
- 361. Extension of limitation or liability.
- 362. Limitation of liability of port authorities and owners of docks.
- 363. Ships less than 300 tons.
- 364. Calculation of tonnage.
- 365. Release of ship on security.
- 366. Rules as to division of liability.
- 367. Joint and several liability.
- 368. Right of contribution.
- 369. Extended meaning of owners.

SECTION

**PART XIX  
INQUIRIES**

- 370. Investigations of shipping casualties.
- 371. Preliminary inquiry.
- 372. Formal investigation.
- 373. Expenses of witnesses.
- 374. Effect on certificates or licences.
- 375. Inquiry into fitness or conduct.
- 376. Rehearing and appeal.
- 377. Appeals to High Court.
- 378. Delivery of certificates, etc.
- 379. Power of Minister.

**PART XX  
JURISDICTION**

- 380. Jurisdiction.
- 381. Jurisdiction over ship lying or passing off the coast.
- 382. Jurisdiction as to offences on board ships.
- 383. Jurisdiction in collision and other cases.
- 384. Actions *in rem*.
- 385. Jurisdiction as to unsatisfied mortgages.

**PART XXI  
DETENTION OF AND DISTRESS ON SHIP FOR  
DAMAGE CAUSED**

- 386. Inquiry into death on board.
- 387. Detention of ship.
- 388. Seizure and sale.
- 389. Distress on ship.

**PART XXII  
COURT OF SURVEY**

- 390. Constitution of Court of Survey.
- 391. Jurisdiction of Court of Survey.

ARRANGEMENT OF SECTIONS—*Continued*

**SECTION**

- 392. Expert witnesses.
- 393. Power to make Rules.

**PART XXIII**

**LEGAL PROCEEDINGS**

- 394. Prosecution of offences and penalties.
- 395. Limitation of time as to summary proceedings.
- 396. Compounding of offences.
- 397. Limitation of actions in civil proceedings.
- 398. Depositions in cases in which witnesses cannot be produced.
- 399. Evidence and service of documents.
- 400. Admissibility of documents in evidence.
- 401. Service of documents.

**PART XXIV**

**ADMINISTRATION OF THE ACT**

- 402. Power of the Minister to administer the Act.
- 403. Office of the Director of Maritime Services.
- 404. Delegation of powers.
- 405. Protection of public officers.
- 406. Power of Minister to make Regulations.
- 407. Consolidated Fund.
- 408. Amendment of Schedule.
- 409. Application.
- 410. Conventions to prevail.
- 411. Contravention of international conventions.

**PART XXV**

**FINAL AND TRANSITIONAL PROVISIONS**

- 412. Exemption of Trinidad and Tobago Government ships from the application of this Act.
- 413. Repeal.

**SCHEDULE.**

**CHAPTER 50:10**

**SHIPPING ACT**

**An Act to make provision for the registration and licensing of ships, matters relating to crews, safety of life at sea and matters incidental thereto.** 24 of 1987.

[3RD DECEMBER 1987]

Commencement.  
[220/1987].

WHEREAS it is enacted by section 13(1) of the Constitution that an Act of Parliament to which that section applies may expressly declare that it shall have effect even though inconsistent with sections 4 and 5 of the Constitution and, if any Act does so declare, it shall have effect accordingly: Preamble.

And whereas it is provided in section 13(2) of the Constitution that an Act of Parliament to which that section applies is one the Bill for which has been passed by both Houses of Parliament and at the final vote thereon in each House has been supported by the votes of not less than three-fifths of all the members of that House:

And whereas it is necessary and expedient that the provisions of this Act shall have effect notwithstanding sections 4 and 5 of the Constitution:

**1.** This Act may be cited as the Shipping Act. Short title.

**PART I**

**PRELIMINARY**

**2.** In this Act— Interpretation.

“agent” means in relation to a ship, an agent of the owner, not being a managing owner, vested with a specific authority by the owner;

“aircraft” means any ship or vessel designed for flying but capable of being manoeuvred on water and includes a seaplane or any ship or vessel able to alight or hover over water;

“apprentice” means an apprentice to the sea service;

“bankruptcy” includes insolvency and any other process leading to liquidation of assets;

“cargo” includes livestock;

“cargo ship” means a ship which is not a passenger ship, or a fishing vessel;

“Caribbean Community” means the Community established under the Treaty done at Chaguaramas on 4th July, 1973;

“Caricom State” means a State member of the Caribbean Community;

“Comptroller” means the Comptroller of Customs and Excise;

“consular officer” means a person discharging the duties of a consular office on behalf of the Government of Trinidad and Tobago and when used in relation to a State other than Trinidad and Tobago “consular officer” means the officer recognised by the Government of Trinidad and Tobago as a “consular officer” of that State;

“crew” in relation to a ship includes seamen and apprentices;

“Director” means the Director of Maritime Services as referred to in section 403(2)(a) and includes any person lawfully acting under the instructions or on behalf of the Director;

“fishing vessel” means a vessel used or intended to be used for catching fish for gain;

“foreign ship” means a ship which is not a Trinidad and Tobago ship;

“Inspector” means a person designated by the Registrar of Seamen to inspect ships;

“international voyage” means a voyage from a port in one State to a port in another State;

“licensed Trinidad and Tobago ship” means a ship that is licensed pursuant to section 40(1);

“machinery” includes propulsion systems, steering systems, pressurised containers and systems, pumping systems, windlasses, electrical systems and all similar apparatus required for, or affecting, the safety or operation of a ship or the safety of the personnel on board a ship;

“managing owner”, in relation to a ship, includes any person not being an agent in whom an owner of such ship has vested authority to manage and operate the ship;

“marine officer” means a person referred to as such in section 403(2);

“master” includes every person having command or charge of any ship, other than a pilot;

“merchant ship” includes a cargo ship and a passenger ship;

“Minister” means the Minister to whom the responsibility for shipping is assigned;

“nationals of Trinidad and Tobago” includes—

- (a) citizens of Trinidad and Tobago;
- (b) residents as defined in section 5 of the Immigration Act;
- (c) corporations established by or under the laws of Trinidad and Tobago having the principal place of business in Trinidad and Tobago;

Ch. 18:01.

“owner”, in relation to a ship, includes a demise or bareboat charterer and a managing owner;

“passenger” means any person carried on board a ship except—

- (a) the master, a member of the crew, an apprentice or a person employed or engaged in any capacity on board the ship on the business of the ship;
- (b) a child under one year of age; or
- (c) a person carried on the ship under an obligation imposed upon the master to carry shipwrecked, distressed or other persons, or by reason of any circumstances which neither the master nor the owner nor the charterer, if any, could prevent or forestall;

“passenger ship” means a ship which is constructed for, or which is habitually or on any particular occasion used for carrying more than twelve passengers;

“person qualified to own a Trinidad and Tobago ship” has the meaning assigned to it in section 4;

“pilot”, in relation to any ship, means any person not belonging to the ship who has the conduct thereof;

“pleasure craft” means a ship, however propelled, that is used exclusively for pleasure and does not carry passengers or cargo for hire or reward, but does not include a ship that is provided for the transport or entertainment of lodgers at any institution, hotel, boarding house, guest house or other establishment;

“port” includes a place and a harbour;

“Port of Registry”, in relation to any ship, means the port where she is for the time being registered;

“Principal Receiver” means the Principal Receiver of Wreck referred to in section 330;

“proper officer” in relation to any function or activity means a person authorised to perform that function or activity and may include a “consular officer”;

“Receiver” means a receiver of wreck so designated under section 320;

“Registrar”, in relation to Part III, means the Registrar of Ships;

“salvage” includes all expenses properly incurred by a salvor in the performance of salvage services;

“seaman” includes every person employed or engaged in any capacity on board any ship, other than a master or a pilot or a person temporarily employed on the ship while in port, and apprentices, except for the purposes of sections 171 to 195 inclusive;

“ship” includes every description of vessel used in navigation and not propelled by oars;

“shipwrecked persons” means persons belonging to any ship referred to in section 322;

“surveyor” means a person appointed as such under section 27;

“tackle”, used in relation to a vessel, means the tackle, machinery, gear, apparatus and appliances used on board a ship for the loading and unloading thereof;

“Trinidad and Tobago Government ship” means a ship which belongs to the Government of the Republic of Trinidad and Tobago but does not include a ship which forms part of the Defence Force of Trinidad and Tobago;

“Trinidad and Tobago ship” means a ship which is—

- (a) registered or licensed in Trinidad and Tobago under this Act; or
- (b) exempted under this Act from being registered or licensed;

“vehicle” includes any vehicle of any description, whether propelled by mechanical power or otherwise, and whether used for drawing other vehicles or otherwise;

“vessel” includes any ship or boat or any other description of vessel used or designed to be used in navigation;

“waters of Trinidad and Tobago” includes the internal waters and the territorial sea as defined in the Territorial Sea Act, and the archipelagic waters as defined in the Archipelagic Waters and Exclusive Economic Zone Act;

Ch. 1:51.

Ch. 51:06.

“wreck” includes—

- (a) flotsam, jetsam, lagan and derelict found in the waters or on the shores of Trinidad and Tobago;
- (b) cargo, stores, tackle or equipment;
- (c) the personal property of shipwrecked persons; and
- (d) any wrecked aircraft or any part thereof and cargo thereof.

## PART II

### RESTRICTION ON TRADING

**3.** (1) No ship shall trade in or from the waters of Trinidad and Tobago unless the ship—

Restriction on trading in Trinidad and Tobago.

- (a) is a Trinidad and Tobago ship; or
- (b) is provided with a certificate of foreign registry or other document similar or equivalent to that required by this Act.

(2) Every Trinidad and Tobago ship trading in any waters and every ship trading in or from the waters of Trinidad and Tobago shall provide evidence of financial responsibility against risks of damage to third parties in such a manner as may be prescribed.

(3) The owner, agent and master of every ship who contravenes subsection (1) or (2) is guilty of an offence and is liable to a fine of five thousand dollars and the ship shall be liable to be detained.

### PART III

## REGISTRATION AND LICENSING OF SHIPS

### REGISTRATION

Qualifications for owning Trinidad and Tobago ships.

4. Subject to subsections (7) and (8) of section 5, a ship shall not be registered in Trinidad and Tobago under this Act unless she is owned wholly by persons qualified to own a Trinidad and Tobago ship, namely—

- (a) nationals of Trinidad and Tobago;
- (b) citizens of Caricom States residing in a member State of the Caribbean Community, where the ship is customarily engaged in international voyages;
- (c) individuals or corporations owning ships hired out on bareboat charter to nationals of Trinidad and Tobago;
- (d) individuals or corporations in bona fide joint venture shipping enterprise relationships with nationals of Trinidad and Tobago as may be prescribed;
- (e) such other persons as the Minister may by Order determine, subject to affirmative resolution of Parliament.

Obligations to register Trinidad and Tobago ships.

5. (1) Whenever a ship is owned wholly by persons qualified to own a registered Trinidad and Tobago ship, that ship shall, unless it is registered in some other State, be

registered in Trinidad and Tobago in the manner provided in this Part, unless—

- (a) the ship is recognised by the law of a State other than Trinidad and Tobago as a ship of that State, and is by the law of that State exempted from registration;
- (b) the ship is, pursuant to subsection (2), exempted from registration under this Act;
- (c) the ship is required to be licensed and operates solely within the waters of Trinidad and Tobago; or
- (d) the ship is exempt from being licensed.

(2) The Minister may by Notice exempt generally or specifically from registration under this Act, a licensed Trinidad and Tobago ship or a class thereof or a ship or a class of ship that is required to be licensed when operating outside the waters of Trinidad and Tobago.

(3) Every Trinidad and Tobago ship, and every Trinidad and Tobago Government ship shall be registered in one of the register books kept pursuant to section 14 and registration shall be effected in accordance with this Act.

(4) If the master of any ship which is owned wholly by persons qualified to own a registered Trinidad and Tobago ship or a licensed Trinidad and Tobago ship fails, on demand, to produce the Certificate of Registry or the licence as the case may be, of the ship or such other evidence as satisfies the Minister that the ship complies with the requirements of subsection (1), that ship may be detained until that evidence is produced.

(5) Any ship which is wholly owned by persons qualified to own a Trinidad and Tobago ship, and which immediately before the commencement of this Part, is registered in Trinidad and Tobago in accordance with the Merchant Shipping Act, 1894, is entitled to be registered under this Act, but subject to such conditions as may be prescribed.

(6) A ship required to be registered or licensed under this Act shall not be recognised as a Trinidad and Tobago ship and is not entitled to the rights and privileges accorded to Trinidad and Tobago ships under this Act unless it is so registered or licensed.

(7) The Minister may make Regulations for the purpose of giving full effect to this section and, in particular for matters relating to—

- (a) the obligation to register ships and failure to comply therewith;
- (b) the manner in which Trinidad and Tobago Government ships, or any class of those ships may be registered under this Act.

(8) Subject to any modifications which may be made by those Regulations either generally or in respect of any specified class of ship, this Act shall apply to Trinidad and Tobago Government ships which are registered in accordance with the Regulations as if they were ships registered in the manner provided in this Part.

(9) Where the Minister has reason to believe that there is some doubt as to the title of any ship registered under this Act, he may direct the Registrar to require that evidence be given to his satisfaction that the ship is entitled to be so registered; and where, within such time as may be prescribed by the Minister, not being less than thirty days, evidence to the satisfaction of the Registrar of the title of the ship is not given, the ship shall be liable to be deregistered.

Registrar of  
ships and  
Deputy  
Registrar.

**6.** (1) The Director may be the Registrar of ships and the Minister may designate a Deputy Registrar at such Port of Registry as he may deem fit.

(2) In the exercise of his functions under this Act, a Deputy Registrar designated under subsection (1) shall be subject to such directions as the Director may, from time to time, give to him in that behalf.

Application for  
registration.

**7.** (1) Application for registration of a ship under this Act shall be made to the Registrar in the prescribed form.

(2) The application shall be made, in the case of individuals, by the person requiring to be registered as owner, or by some one or more of the persons so requiring, if more than

one, or by his or their agent, and, in the case of a corporation, by its agent; and the authority of the agent shall be testified by writing, if appointed by individuals, under the hands of the appointors, and, if appointed by a corporation, under the common seal of the corporation.

(3) The Registrar may require proof of ownership to his satisfaction before proceeding with the registry of a ship.

**8.** (1) A person shall not be entitled to be registered as owner of a Trinidad and Tobago ship or of a share therein until he, or in the case of a corporation, a person authorised on behalf of the corporation, has made and signed a declaration of ownership referring to the ship as described in the Certificate of Survey and containing the following particulars:

Declaration of ownership on registration and other evidence required.

- (a) his full name and address;
- (b) a statement of the number of shares in the ship of which he or the corporation, as the case may be, is entitled to be registered as owner;
- (c) a declaration that, to the best of his knowledge and belief, the owner of the ship or every owner of every share therein is a person qualified to own a Trinidad and Tobago ship.

(2) A declaration of ownership by an individual owner and a declaration of ownership on behalf of a corporation as owner, shall each be made in the prescribed form.

**9.** (1) In addition to the declaration of ownership, the following evidence shall be produced to the Registrar on the first registration of a ship:

Evidence on first registry.

- (a) in the case of a ship built within the Caribbean Community—
  - (i) a builder's certificate, that is to say, a certificate signed by the builder of the ship, and containing a true account of—
    - (A) the proper denomination and tonnage of the ship as determined by him;

- (B) the time when and place where the ship was built;
- (C) the name of the person, if any, on whose account the ship was built; and
- (ii) if there has been any sale, the bill of sale under which the ship, or a share therein, has become vested in the applicant for registration;
- (b) in the case of a ship built outside the Caribbean Community, the same evidence as in the case of a ship built within the Community, unless the person who makes the declaration of ownership declares that the time and place of the building of the ship are not known to him, or that the builder's certificate cannot be produced, in which case only the bill of sale under which the shares in the ship became vested in the applicant for registration, shall be produced;
- (c) in the case of a ship condemned by a competent Court, an official copy of the order of condemnation.

(2) In the case of every ship built in Trinidad and Tobago, the builder shall, if requested to do so, deliver to the owner a signed certificate containing the particulars specified in paragraph (a) of subsection (1).

(3) If any builder fails to comply with subsection (1) or (2) or wilfully makes a false statement in a certificate given thereunder, he is guilty of an offence and is liable to a fine of five thousand dollars.

Restrictions on registration.

**10.** (1) Subject to subsection (2), a ship which is or has been registered in any State shall not be eligible for registration under this Act unless:

- (a) a certificate has been issued by such State to the effect that the ship has been deregistered; or
- (b) a certificate has been issued by such State to the effect that the ship will be deregistered on the day that the new registration is effected.

(2) The Minister may in his discretion waive the provisions of subsection (1) where any person applying for registration of a ship provides reasons satisfactory to the Minister for his inability or failure to comply with the said provisions.

**11.** Subject to section 10 a ship shall not be registered as a Trinidad and Tobago ship unless the foreign registration is cancelled, and the registration of a ship shall be cancelled if at any time it—

Cancellation of registration.

- (a) appears to be registered also in a foreign registry;
- (b) ceases to comply with the qualifications for the ownership of Trinidad and Tobago ships as required by section 5;
- (c) appears to have been lost or broken up.

**12.** The Registrar shall not permit the deregistration of a ship without the consent in writing of all of the holders of mortgages and preference rights in the said ship registered under this Act.

Restriction on deregistration of ships.

**13.** (1) The port of Port-of-Spain shall be the Port of Registry for the registration of ships.

Port of Registry.

(2) The Minister may by Order declare any other port of Trinidad and Tobago as a Port of Registry.

**14.** (1) The Registrar of Ships shall keep such register books as may be deemed necessary, including the following:

Register books.

- (a) a register book for merchant ships;
- (b) a register book for fishing vessels;
- (c) a register book for ships under construction.

(2) Entries in those books shall be made in accordance with the following provisions:

- (a) the property in a ship shall be divided into sixty-four shares;
- (b) subject to the provisions of this Part with respect to joint owners or owners by transmission, not more than sixty-four individuals shall be entitled

to be registered at the same time as owners of any one ship; but this provision shall not affect the beneficial title of any number of individuals or of any corporation represented by or claiming under or through any registered owner or joint owner;

- (c) a person shall not be entitled to be registered as owner of a fractional part of a share in a ship; but any number of persons not exceeding five may be registered as joint owners of a ship or of any share or shares therein;
- (d) joint owners shall be considered as constituting one person only as regards the persons entitled to be registered, and shall not be entitled to dispose in severalty of any interest in a ship, or in any share therein in respect of which they are registered;
- (e) a corporation may be registered as owner by its corporate name.

(3) As soon as the requirements of this Part preliminary to registration have been complied with, the Registrar shall enter in the register book the following particulars respecting the ship:

- (a) the name of the ship and the previous name and registry, if any;
- (b) the details contained in the Certificate of Survey;
- (c) the particulars respecting its origin stated in the declaration of ownership;
- (d) the name, address, occupation and nationality of its owner and where there is more than one owner what share in the ship is held by each;
- (e) the Port of Registry or home port and the official number or identity mark;
- (f) the international call sign of the ship, where one is assigned;
- (g) the name of the builders, place and year of building of the ship;

- (h) the description of the main technical characteristics of the ship;
- (i) details with respect to any mortgages.

(4) Only those individual owners, joint owners, and corporations recorded as owners in the register books shall be regarded as owners of the ship or part thereof.

(5) The Registrar shall keep a record in the manner approved by the Minister of—

- (a) the date of deletion or suspension of the previous registration of the ship;
- (b) the name, address and, as appropriate, the nationality of the bareboat charterer;
- (c) maritime liens or other charges.

(6) On the registration of a ship, the Registrar shall retain in his possession the following documents:

- (a) the Certificate of Survey;
- (b) the builder's certificate, if any;
- (c) all declarations of ownership;
- (d) any bill of sale of the ship previously made;
- (e) the copy of the condemnation, if any;
- (f) the notice of name of the ship;
- (g) the application for registration.

(7) Any person may, upon payment of the prescribed fee, have access to the register book at any Port of Registry at any reasonable time during the hours of official attendance of the Registrar.

**15.** The Minister may make Regulations prescribing the class of vessel required to be registered in the register book for merchant ships. Registration of merchant ships.

**16.** (1) Every merchant ship registered in the register book for merchant ships shall have a name; and two or more merchant ships shall not bear the same name. Name of ship.

(2) The Registrar may refuse the registration of a ship by a name proposed for the registration if the name is already the name of a Trinidad and Tobago ship or a name calculated to deceive or to offend the public interest.

(3) A Trinidad and Tobago ship shall not be described by any name other than that by which the ship is for the time being registered.

Change of name  
of ship.

**17.** (1) A change may not be made in the name of a Trinidad and Tobago ship without the previous written consent of the Director.

(2) Application for a change of name shall be made on the prescribed form.

(3) The Director may not grant permission to change the name of a Trinidad and Tobago ship, unless he is satisfied that all registered mortgagees thereof have been notified of the proposed change of name.

(4) An approval for a change of name shall be granted by the Registrar in accordance with the Regulations and a change of name of a ship in the register shall be carried out in the manner set out in the Regulations.

Register book  
for fishing  
vessels.

**18.** (1) The Minister may make Regulations prescribing the class of vessels required to be registered in the register book for fishing vessels.

(2) On the registration of a fishing vessel the Registrar shall allocate to it a combination and sequence of letters and numerals (hereinafter called the "identity mark") which he shall cause to be entered in the register book.

(3) The same letters and identity mark of a registered fishing vessel shall not be allocated to any other fishing vessel.

(4) Every registered fishing vessel shall display the identity mark allocated to it under this section on each side of its bow and shall show its Port of Registry on the stern.

(5) The master and owner of a fishing vessel which displays an identity mark not allocated to it under this section is guilty of an offence.

**19.** (1) A person is guilty of an offence who contravenes or permits any other person under his control to contravene section 16 or 17. Offences.

(2) The Director may suspend the certificate of registry of a ship until any contravention of section 16 or 17 is remedied.

**20.** A merchant ship or a fishing vessel which is equipped either with a wireless radio transmitting station or with a radio-telephony installation shall also have an internationally registered code designation, that is to say, international call letters or numbers as appropriate to the flag State of registration and assigned to the ship. Call sign.

**21.** (1) The Minister may make Regulations prescribing— Register book for ships under construction.

- (a) the class of ship required to be registered in the register book for ships under construction;
- (b) the conditions and guidelines subject to which the rights of ships under construction shall be registered, and the manner in which such a record shall be kept.

(2) A ship under construction may be entered in the register book for ships under construction from the date of the signing of the contract for construction until it is placed on another register after completion.

**22.** (1) Before a ship is registered in Trinidad and Tobago— Surveys and measurement of ships.

- (a) it shall be surveyed by a surveyor and its tonnage ascertained in accordance with the Regulations;
- (b) the surveyor shall deliver to the Registrar a Certificate of Survey on the prescribed form specifying the ship's tonnage, the time and place of construction and such other particulars descriptive of the identity of the ship as the Registrar may require;
- (c) the Registrar or any person delegated by him shall on the basis of the certificate referred to in paragraph (b), issue a tonnage certificate in the manner prescribed.

(2) The Minister may by Regulations, hereinafter referred to as “the Tonnage Regulations” —

- (a) provide for ascertaining the tonnage of ships;
- (b) make different provisions for different descriptions of ships or for the same description of ships in different circumstances;
- (c) make any provision of the Regulations dependent on compliance with such conditions to be evidenced in such manner as may be specified in the Regulations;
- (d) prohibit or restrict the carriage of goods or stores in spaces not included in the registered tonnage of a ship and provide for making the master and the owner each liable to a fine of five thousand dollars when such a prohibition or restriction is contravened.

(3) In the Tonnage Regulations, provision may be made—

- (a) for assigning to a ship, either instead of or as an alternative to the tonnage ascertained in accordance with the other provisions of the Regulations, a lower tonnage applicable where the ship is not to be loaded to the full depth to which it can otherwise be safely loaded;
- (b) for indicating on the ship by such mark as is specified, that such a lower tonnage has been assigned to it and, where it has been assigned to it as an alternative, the depth to which the ship can be loaded for the lower tonnage to be applicable; and
- (c) for the issue of documents certifying the registered tonnage of any ship or the tonnage that is to be taken for any purpose specified as the tonnage of a ship not registered in Trinidad and Tobago.

(4) In making the Tonnage Regulations the Minister shall have due regard to the International Convention on Tonnage Measurement of Ships 1969, including any amendments thereof.

**23.** (1) Where the tonnage of a ship has been ascertained in accordance with the Tonnage Regulations and registered, that tonnage shall thenceforth be deemed to be the tonnage of that ship.

Tonnage once ascertained to be tonnage of ship.

(2) The tonnage of a ship as ascertained under subsection (1), shall be entered in every subsequent registration of the ship unless—

- (a) an alteration is made in the form or capacity of the ship; or
- (b) it is discovered that the tonnage of the ship has been erroneously computed,

and in either of those cases the ship shall be remeasured and her tonnage determined and registered according to the Tonnage Regulations.

**24.** (1) Where it appears to the Minister that a foreign State has promulgated rules on tonnage that are substantially the same as those under the Tonnage Regulations, the Minister may order that the ships of that State without being remeasured in Trinidad and Tobago, be deemed to be of the tonnage denoted in their certificate of registry or other national papers in the same manner, to the same extent and for the same purposes as the tonnage denoted in the certificate of registry of a Trinidad and Tobago ship is deemed to be the tonnage of that ship.

Tonnage of foreign ship.

(2) Any space shown by the certificate of registry or other national papers of any foreign ship described in subsection (1) as deducted from tonnage, on account of being occupied by seamen or apprentices and appropriated to their use, shall be deemed to have been certified under this Act and to comply with those provisions of this Act that apply to such a space in the case of Trinidad and Tobago ships, unless a surveyor inspects the ship and certifies to the Minister that the construction and the equipment of the ship in respect of that space do not meet the standard required of a Trinidad and Tobago ship under this Act, in which case the ship shall be remeasured and assigned a tonnage in accordance with this Act.

(3) Where it appears to the Minister that the tonnage of a foreign ship as measured by the rules as to tonnage of the State to which it belongs materially differs from that which would be its tonnage if measured under this Act, the Minister may order that, any of the ships of that State be remeasured in accordance with this Act, for all or any of the purposes of this Act.

Foreign and other measurements.

**25.** (1) Where a ship has been measured and registered as a foreign ship or has already been measured without being registered as a Trinidad and Tobago ship, a surveyor may, for the purposes of section 22, accept and use any figures of measurement contained in the latest register relating to that ship, or in the case of an unregistered ship, in the latest certificate of measurement relating to that ship.

(2) Before acting under subsection (1), the surveyor shall satisfy himself that there have been no changes of measurement since the making of the register or certificate that he proposes to use; and where any such changes have been made he shall remeasure the ship to the extent made necessary by the changes.

Alterations between surveys.

**26.** Where any alteration or reconstruction of a Trinidad and Tobago ship is made that could affect the ship's classification, measurement, tonnage or load line, the owner or master of the ship shall, within thirty days after the completion of the alteration or reconstruction, advise the Registrar of the alteration or reconstruction and give him details thereof.

Appointment of surveyors.

**27.** (1) The Minister may appoint duly qualified persons within or outside Trinidad and Tobago as surveyors to survey and measure ships under and for the purposes of this Act.

(2) The Minister may, by Regulations, nominate any person within or outside Trinidad and Tobago to be a classification society for the purposes of this Act and any classification society so appointed may appoint any person to survey and measure ships under and for the purposes of this Act.

Marking of ships.

**28.** (1) Every ship shall, before being registered in Trinidad and Tobago, be marked permanently and conspicuously in accordance with the Regulations.

(2) Where the Registrar is satisfied that a ship is insufficiently or inaccurately marked, he may suspend the Certificate of Registry of the ship or in the absence of such certificate he may detain the ship until the insufficiency or inaccuracy has been remedied to his satisfaction.

(3) The Minister may make Regulations exempting any class of ship from all or any of the requirements of this section.

#### CERTIFICATE OF REGISTRY

**29.** (1) On the completion of the registration of a ship, the Registrar shall grant a certificate of registry in the prescribed form.

Issue and custody of Certificate of Registry.

(2) The Certificate of Registry shall be kept on board the ship and shall be used only for the lawful navigation of the ship and shall not be subject to retention by reason of any title, lien, charge or other interest of any owner, mortgagee, or other person.

(3) No person who has in his possession, or under his control, the Certificate of Registry of a ship shall refuse or omit, without reasonable cause, to deliver the certificate on demand to the person entitled to the custody thereof for the purposes of the lawful navigation of the ship, or to any Registrar, ship surveyor, officer of Customs and Excise or other person entitled by law to require its delivery.

(4) Every person who contravenes subsection (3) is guilty of an offence and is liable to a fine of five hundred dollars.

(5) If, in any proceedings in respect of an offence under this section, the Court is satisfied that the certificate is lost, the Court shall so advise the Minister in writing.

**30.** Where the owner or master of a ship, whether or not the ship is a Trinidad and Tobago ship, uses or attempts to use for its navigation a Certificate of Registry not legally granted in respect of the ship, he is guilty of an offence and is liable to a fine of twenty thousand dollars and to imprisonment for a term of two years, and, in addition, the ship shall be liable to forfeiture.

Use of improper certificate.

Power to make Regulations in relation to Certificate of Registry.

**31.** The Minister may make Regulations relating to—

- (a) the grant of a new Certificate of Registry;
- (b) the loss of a Certificate of Registry;
- (c) the keeping of a record of masters;
- (d) the endorsement of a change of ownership on a Certificate of Registry;
- (e) the delivery up of the Certificate of Registry of a ship that is lost or broken up or has ceased to be a Trinidad and Tobago ship.

Provisional Certificate of Registry.

**32.** (1) Where owners of a ship intend to apply to have the ship registered as a Trinidad and Tobago ship but there is no Registrar immediately available, a proper officer or other appropriate authority designated to act on behalf of the Government may grant to its owner or master, on his application, a provisional certificate stating—

- (a) the name of the ship;
- (b) the time and place of its purchase and the names of its purchasers;
- (c) the name of its master;
- (d) the best particulars respecting its tonnage, the time and place of its construction and other particulars which he is able to obtain,

and shall forward a copy of the certificate at the first convenient opportunity to the Registrar.

(2) A provisional certificate under this section shall have the effect of a Certificate of Registry until the expiration of six months after its date of issue or until the arrival of the ship at a port in Trinidad and Tobago whichever first happens, and on either of those events happening shall cease to have effect.

(3) The master of every ship in respect of which a provisional certificate is granted under this section shall, within ten days of the ship's first arrival thereafter at a port in Trinidad and Tobago, deliver the certificate to the Registrar; and where any master fails to comply with this subsection, he is guilty of an offence and is liable to a fine of five hundred dollars.

(4) The Minister may make Regulations prescribing the form, the contents and the entries to be contained in provisional Certificates of Registry granted under this section.

**33.** (1) Where it appears to the Minister that by reason of special circumstances it is desirable that permission be granted to a ship to pass, without being previously registered, from any port in Trinidad and Tobago to any other port within or outside Trinidad and Tobago, the Minister may, in any case in which the ship belongs to a State whose law provides for the issue of temporary passes, direct the Registrar to grant a pass and that pass for the time and within the limits therein mentioned shall have the same effect as a Certificate of Registry; and the Registrar when so directed shall grant the pass accordingly.

Temporary pass  
in lieu of  
Certificate of  
Registry.

(2) The Minister may by Regulations prescribe the procedure, form and conditions to be attached to the issue of temporary passes under this section.

#### REGISTRATION OF ALTERATIONS AND REGISTRATION ANEW

**34.** (1) When a Trinidad and Tobago ship is so altered as not to correspond with the particulars relating to its tonnage or description in the register, notification of the alteration shall be given within thirty days after the completion of the alteration to the Registrar; and the notice shall be accompanied by a Certificate of Survey stating the particulars of the alteration.

Registration of  
alteration.

(2) Upon receipt of a notice of alteration of a Trinidad and Tobago ship under subsection (1), the Registrar shall either cause the alteration to be registered or direct that the ship be registered anew.

(3) Where there is a failure to comply with the requirements of subsection (1) or with a direction under subsection (2), the Registrar may suspend the Certificate of Registry of the ship in respect of which the failure occurs.

**35.** (1) On the registration of an alteration in a Trinidad and Tobago ship, the ship's Certificate of Registry shall be produced to the Registrar within sixty days after the registration.

Alterations  
noted on  
Certificate of  
Registry.

(2) Where a Certificate of Registry has been produced to the Registrar under subsection (1), the Registrar may —

- (a) endorse and sign on that certificate a statement of the alteration; or
- (b) retain that certificate and issue a new Certificate of Registry that contains a description of the ship as altered.

Provisional  
certificate where  
ship registered  
anew.

**36.** (1) Where a Trinidad and Tobago ship is outside of Trinidad and Tobago, and consequent upon notification as to alterations in the ship, the Registrar directs that the ship is to be registered anew, a proper officer or other appropriate authority designated to act on behalf of the Government shall grant to the master on his application, either a provisional certificate, describing the ship as altered, or provisionally endorse the particulars of the alteration on the existing certificate.

(2) Where the proper officer or other appropriate authority grants a provisional certificate or provisionally endorses a certificate under this section, he shall add to the certificate or endorsement a statement that the same is made provisionally.

(3) The master of every ship in respect of which a provisional certificate is granted or a certificate is endorsed under this section shall, within ten days of the ship's arrival thereafter at a port in Trinidad and Tobago or within six months of the date of issue or endorsement of the certificate, whichever is the sooner, deliver that certificate to the Registrar, and, if any master fails to comply with this subsection, he is guilty of an offence and is liable to a fine of one thousand dollars.

(4) Where any ship in respect of which a provisional certificate is granted or a certificate is endorsed under this section first arrives thereafter at a port in Trinidad and Tobago, application for registration of that ship anew shall be made to the Registrar, and the other requirements requisite for registry shall be complied with; and, if, in respect of any such ship, there is failure to comply with this subsection, the owner of the ship is guilty of an offence and is liable to a fine of one thousand dollars and, in addition, to a further fine of one hundred dollars for every day during which the offence continues after conviction.

**37.** Where the ownership of a Trinidad and Tobago ship is changed, the Registrar may, on the application of the owner of the ship, register the ship anew, even though registration anew is not required under this Part.

Registration anew on change of ownership.

**38.** (1) When registering a Trinidad and Tobago ship anew, the Registrar, shall proceed as in the case of a first registration and—

Procedure for registration anew.

- (a) on delivery to him of the existing Certificate of Registry and on compliance with other requirements for first registry as applicable; or
- (b) in the case of a change of ownership, on compliance with such of the requirements for registration as he thinks applicable,

make a registration anew in respect of that ship and issue a new Certificate of Registry thereof.

(2) When a ship is registered anew, the former registration of the ship is closed and the names of all persons appearing by the former registration as owner, mortgagees or holders of other interests in the ship registered anew shall be entered on the new registration.

(3) A registration anew does not in any way adversely affect the rights of any persons described in subsection (2).

**39.** Where the registration of a Trinidad and Tobago ship is closed because the ship has been wrecked or abandoned, the ship shall not be re-registered until it has, at the expense of the applicant for re-registration, been surveyed by a surveyor and certified by him to be seaworthy.

Restriction on re-registration of wrecked or abandoned ships.

#### LICENSING

**40.** (1) Subject to subsections (2) and (3), every ship under twenty-four metres in length shall be licensed under this Act.

Ships to be licensed.

(2) The following ships shall be exempt from being licensed under this section:

- (a) pleasure craft of less than five metres in length not equipped with propulsion machinery;

(b) pleasure craft of less than three metres in length equipped with propulsion machinery of not more than five horse power;

(c) ships registered under this Act.

(3) The Minister may in writing exempt, either generally or specifically, ships from compliance with subsection (1), subject to such conditions as he may stipulate.

Qualifications  
for owning  
Trinidad and  
Tobago ships.

**41.** (1) A ship shall not be licensed in Trinidad and Tobago unless it is owned wholly by individuals or corporations ordinarily resident in Trinidad and Tobago.

(2) No more than eight persons may be recorded as joint owners of a licensed Trinidad and Tobago ship.

(3) Within seven days, or such further time as may be allowed by the Minister, after a change of ownership of a Trinidad and Tobago ship, the owner shall in writing notify the Registrar of such change.

(4) Where the owner of a licensed Trinidad and Tobago ship ceases to be resident in Trinidad and Tobago, or where he fails to comply with subsection (3), the licence of the ship shall be deemed to have been cancelled.

(5) The Minister may in writing exempt any ship from the provisions of subsection (1).

Operating  
restrictions.

**42.** (1) Subject to subsection (2), a licensed Trinidad and Tobago ship shall—

(a) operate only within the waters of Trinidad and Tobago;

(b) comply with such conditions as may be endorsed on the licence.

(2) The Minister may in writing exempt a licensed Trinidad and Tobago ship from any of the provisions of subsection (1).

Regulations.

**43.** The Minister may make Regulations regarding the licensing of ships and licensed Trinidad and Tobago ships, and in particular for the following matters:

(a) the manning of and the life-saving, safety and fire-fighting equipment to be carried on such ships;

- (b) the examination and certification of skippers, mechanics and deckhands;
- (c) surveys and inspections;
- (d) the appointment of surveyors;
- (e) the keeping of records;
- (f) fees;
- (g) discipline.

**PART IV**

**NATIONAL CHARACTER AND FLAG**

**44.** (1) The Comptroller of Customs and Excise shall not grant a clearance to any ship until the master of the ship has declared to him the name of the State to which he claims the ship belongs, and the Comptroller shall thereupon inscribe that name on the clearance.

National character of ship to be declared before clearance.

(2) Where a ship attempts to proceed to sea without such a clearance, it may be detained until the declaration is made.

**45.** (1) A ship registered or licensed in accordance with this Act shall be entitled to fly the national flag of Trinidad and Tobago.

Right to fly flag of Trinidad and Tobago.

(2) Nothing in this section shall be construed to prohibit Trinidad and Tobago ships which are exempt from registration or licensing under this Act from using on the waters of Trinidad and Tobago the national colours of Trinidad and Tobago.

**46.** (1) The national flag of Trinidad and Tobago constitutes the national colours of a Trinidad and Tobago ship.

Nationality and colours.

(2) Subject to such exemptions as may be prescribed, a Trinidad and Tobago ship shall hoist the national colours on entering or leaving any port, and on a signal being made to the ship by any ship in the service of the Government.

(3) Where a Trinidad and Tobago ship fails to comply with subsection (2), the master of the ship is guilty of an offence and is liable to a fine of five hundred dollars.

(4) Where there are hoisted on board any Trinidad and Tobago ship, any colours or pendant usually worn by ships of the Defence Force of Trinidad and Tobago, or the national colours of

any other State, the master of the ship, or the owner thereof if he is on board the ship, and every other person hoisting the pendant or colours, is guilty of an offence and is liable to a fine of fifteen hundred dollars and to seizure of the colours or pendant by the State.

Penalty for unduly assuming Trinidad and Tobago character.

**47.** (1) Where a person uses the Trinidad and Tobago flag and assumes the Trinidad and Tobago character on board a ship owned in whole or in part by any person not qualified to own a Trinidad and Tobago ship for the purpose of making it appear to be a Trinidad and Tobago ship, it shall be liable to forfeiture under this Act, unless the assumption has been made for the purpose of escaping capture by an enemy or by a foreign ship of war in the exercise of some belligerent right.

(2) In any proceeding for enforcing any such forfeiture the burden of proving the right to use the Trinidad and Tobago flag and to assume the Trinidad and Tobago national character shall be upon the person using and assuming the same.

National flag on foreign ship.

**48.** (1) A person who uses or permits any person to use the flag of Trinidad and Tobago on board a foreign ship for the purpose of making that ship appear to be a Trinidad and Tobago ship is guilty of an offence and liable to a fine of ten thousand dollars and to imprisonment for one year.

(2) In any proceedings under this section the burden of proving the right to use the flag and to assume the appearance of a Trinidad and Tobago ship is upon the person using the flag of Trinidad and Tobago.

Penalty for concealment of Trinidad and Tobago character.

**49.** Where the master or owner of a Trinidad and Tobago ship does anything or permits anything to be done, or carries or permits to be carried any paper or documents, with intent to conceal from any person who is, under the law of Trinidad and Tobago entitled to inquire into the same, the fact that that ship is a Trinidad and Tobago ship, or with intent to assume a foreign character, or with intent to deceive any person so entitled as

aforesaid, the ship shall be liable to forfeiture under this Act; and the master, if he commits or is privy to the commission of the offence, shall on conviction be liable to a fine of five thousand dollars and to imprisonment for one year.

**50.** Where a person who is not qualified to own a registered Trinidad and Tobago ship becomes an owner of a Trinidad and Tobago ship, otherwise than by such transmission as is provided for in this Act, and that ship uses the national colours and assumes the national character of Trinidad and Tobago, it is liable to forfeiture.

Penalty for acquiring ownership if not qualified.

**51.** Where by this Act a ship which is owned wholly by persons qualified to own a registered Trinidad and Tobago ship is not recognised as a Trinidad and Tobago ship, that ship shall not be entitled to any benefits, privileges, advantages or protection usually enjoyed by Trinidad and Tobago ships or to use the national colours or assume the national character of Trinidad and Tobago; but, as to the payment of dues, the liability to fines and forfeiture and the punishment of offences committed on board that ship, or by any persons belonging to it, the ship shall be dealt with in the same manner in all respects as if it were registered in Trinidad and Tobago and recognised as a Trinidad and Tobago ship.

Liabilities of ship not recognised as Trinidad and Tobago ship.

## PART V

### TRANSFERS AND TRANSMISSIONS, MORTGAGES AND MARITIME LIENS

#### TRANSFERS AND TRANSMISSIONS

**52.** (1) A ship or any share therein registered in Trinidad and Tobago when disposed of to a person qualified to own a registered Trinidad and Tobago ship, shall be transferred by a Bill of Sale.

Transfers by Bill of Sale.

(2) The Bill of Sale shall contain such description of the ship as is contained in the Certificate of Survey, or some other description sufficient to identify the ship to the satisfaction of the Registrar and shall be in the form set out as Form A in the Schedule and shall be executed by the transferor in the presence of one witness at least who shall himself add his occupation and address after his signature.

Form A. Schedule.

Declaration of transfer.

**53.** (1) Where a ship registered in Trinidad and Tobago, or any share therein, is transferred, the transferee shall not be entitled to be registered as owner thereof until he, or, in the case of a corporation, the person authorised by this Act to make declarations on behalf of the corporation, has made and signed a declaration referring to the ship, in this Part referred to as a “declaration of transfer”.

(2) A declaration of transfer shall be in the prescribed form, and shall contain—

- (a) a statement of the qualification of the transferee to own a Trinidad and Tobago ship or, if the transferee is a corporation, of such circumstances of the constitution and business thereof as prove it to be qualified to own a Trinidad and Tobago ship; and
- (b) a declaration that, to the best of his knowledge and belief, the owner of the ship or every owner of every share therein is a person qualified to own a Trinidad and Tobago ship.

Bill of Sale to be produced to Registrar for entry in Register.

**54.** (1) Every Bill of Sale for the transfer of a Trinidad and Tobago ship, or a share therein, shall, when duly executed, be produced to the Registrar, with the declaration of transfer; and the Registrar shall thereupon enter in the register book the name of the transferee as the owner of that ship or share, and shall endorse on the Bill of Sale the fact of that entry having been made, with the date and time of acceptance.

(2) Bills of Sale of a ship, or of a share therein, shall be entered in the register book in the order of their production to the Registrar.

Transmission of property in ship on death, bankruptcy, etc.

**55.** (1) When the property in a ship registered in Trinidad and Tobago, or any share therein is transmitted to any person qualified to own a Trinidad and Tobago ship on the death or bankruptcy of any registered owner, or by any lawful means other than by a transfer under this Act—

- (a) that person shall authenticate the transmission by making in a form approved by the Minister and

by signing a declaration (in this Part referred to as a declaration of transmission) identifying the ship and a statement of the manner in which, and the person to whom, the property has been transmitted;

- (b) if the transmission is consequent on death, the declaration of transmission shall be accompanied by a grant of Probate or Letters of Administration in the estate of the deceased owner, or, in the case of the death of a joint owner, by proof of survivorship to the satisfaction of the Registrar; and
- (c) if the transmission is consequent on bankruptcy, the declaration of transmission shall be accompanied by such evidence as is for the time being admissible in any Court in Trinidad and Tobago as proof of the title of persons claiming under a bankruptcy.

(2) The Registrar, on receipt of the declaration of transmission so accompanied, shall enter in the register book the name of the person so entitled under the transmission as owner of the ship or share, the property which has been transmitted, and, where there is more than one such person, shall enter the names of all those persons, but those persons however numerous shall, for the purpose of ownership in the register book be considered as one person.

**56.** (1) Where the property in a Trinidad and Tobago ship or a share therein, is transmitted on death, or bankruptcy, or otherwise to a person not qualified to own a Trinidad and Tobago ship, the High Court may, on application by or on behalf of the unqualified person, order a sale of the property so transmitted, and direct that the proceeds of the sale, after deducting the expenses thereof, be paid to the person entitled under the transmission or otherwise as the Court may direct.

Order of sale on transmission to unqualified person.

(2) The Court may require any evidence it thinks requisite in support of the application, and may make the order on

any terms and conditions the Court thinks just, or may refuse to make the order, and generally may act in the case as the justice of the case requires.

(3) Every such application for sale shall be made within thirty days after the occurrence of the event on which the transmission has taken place, or within such further time, not exceeding in the whole one year from the date of the occurrence, as the Court may allow.

(4) If the application is not made within the time aforesaid, or if the Court refuses an order for sale, the ship or share transmitted shall thereupon be liable to forfeiture.

Transfer of sale of ship by order of Court.

**57.** Where the High Court orders the sale of any ship or share therein, whether under this Part or otherwise, the order of the Court shall contain a declaration vesting in some person named therein the right to transfer that ship or share; and the person so named shall thereupon be entitled to transfer the ship or share in the same manner and to the same extent as if he were the registered owner thereof; and the Registrar shall comply with the requisition of the person so named as if that person were the registered owner.

Court may prohibit any dealing with ship.

**58.** (1) The High Court may, if it thinks fit so to do, without prejudice to the exercise of any other power of the Court, on the application of any interested person, make an order prohibiting for a time specified in the order, any dealing with a ship or a share therein and the Court may make the order on any terms or conditions it thinks just, or may refuse to make the order, or may discharge the order when made, with or without costs, and generally may act in the case as the justice of the case requires; and the Registrar, without being made a party to the proceedings, shall on being served with an order or an official copy thereof obey the same.

(2) An application under this section may be made by summons or otherwise, and either *ex parte* or upon service of notice on any person as the Court or as Rules of Court may direct.

**MORTGAGES**

**59.** (1) A Trinidad and Tobago ship or a share therein, may be made a security for a loan or other valuable consideration, and the instrument creating the security (in this Part referred to as a mortgage) shall be in the form set out as Form B or C in the Schedule.

Method of mortgage of ship or share.

Form B, C. Schedule.

(2) On the production of a mortgage to the Registrar, the Registrar shall record it in the register book.

(3) Mortgages shall be recorded by the Registrar in the order in which they are produced to him for that purpose, and the Registrar shall endorse and sign a statement on each mortgage, stating the date and time of acceptance.

**60.** Where a registered mortgage is discharged, the Registrar shall, on the production of the mortgage, with a receipt for the mortgage money or other release endorsed thereon duly signed and attested, make an entry in the register book to the effect that the mortgage has been discharged; and on that entry being made the estate, if any, which passed to the mortgagee shall vest in the person in whom, having regard to intervening acts and circumstances, if any, it would have vested if the mortgage had not been made.

Entry of discharge of mortgage.

**61.** (1) Where there are more mortgages than one registered in respect of the same ship or share, the mortgagees shall, notwithstanding any express, implied or constructive notice, be entitled in priority one over the other, according to the date and time that each mortgage is recorded in the register book and not according to the date of each mortgage itself.

Priority of mortgages.

(2) A registered mortgage of a ship or share shall not be affected by any act of bankruptcy committed by the mortgagor after the date of the record of the mortgage, notwithstanding that the mortgagor at the commencement of his bankruptcy had the ship or share in his possession, order or disposition, or was the reputed owner thereof.

LAWS OF TRINIDAD AND TOBAGO

MINISTRY OF THE ATTORNEY GENERAL AND LEGAL AFFAIRS

www.legalaffairs.gov.tt

50

Chap. 50:10

Shipping

Mortgagee not treated as owner.

**62.** Except as may be necessary for making a ship or share available as a security for the mortgage debt the mortgagee shall not, by reason of the mortgage, be deemed to be the owner of the ship or share, nor shall the mortgagor be deemed to have ceased to be the owner thereof.

Mortgagee to have power of sale.

**63.** Every registered mortgagee shall have power absolutely to dispose of the ship or share in respect of which he is registered, and to give effectual receipts for the purchase money; but, where there are more persons than one registered as mortgagees of the same ship or share, a subsequent mortgagee shall not, except under the order of the High Court, sell the ship or share without the concurrence of every prior mortgagee.

Transfer of mortgage.

**64.** (1) A registered mortgage of a Trinidad and Tobago ship or a share therein, may be transferred to any person; and the instrument effecting the transfer shall be in the form set out as Form D or E in the Schedule.

Form D, E, Schedule.

(2) On the production of an instrument effecting a transfer of mortgage and of the mortgage to which it relates, the Registrar shall record the transfer by entering in the register book the name of the transferee as the mortgagee of the ship or share, and shall endorse and sign on the mortgage and on the instrument effecting the transfer thereof, a statement that the transfer has been recorded by him, stating the date and time of acceptance.

Transmission of interest in mortgage by death, bankruptcy.

**65.** (1) Where the interest of a mortgagee in a Trinidad and Tobago ship, or any share therein, is transmitted to any person on the death or bankruptcy of the mortgagee, or by any lawful means, other than by a transfer under this Part, the transmission shall be authenticated by a declaration of the person to whom the interest is transmitted.

(2) A declaration made under this section shall be in the prescribed form and shall contain a statement of the manner in which, and the person to whom, the property has been transmitted, and shall be accompanied by the like evidence as is required by this Part in the case of a corresponding transmission of the ownership of a ship or share.

UNOFFICIAL VERSION

UPDATED TO 31ST DECEMBER 2016

(3) The Registrar on the receipt of the declaration, and the production of the evidence as aforesaid, shall enter the name of the person entitled under the transmission in the register book as the mortgagee of the ship or share.

**66.** (1) Where a registered owner of a Trinidad and Tobago ship or a share therein, is desirous of disposing by way of sale or mortgage of that ship or share at any place out of Trinidad and Tobago, he may make application, by declaration in writing, to the Registrar.

Authority to sell  
or mortgage out  
of Trinidad and  
Tobago.

(2) In any such application, there shall be set forth the following particulars:

- (a) the name and address of the person by whom the power mentioned in the certificate is to be exercised, together with—
  - (i) in the case of a sale, the minimum price at which a sale is to be made if it is intended to fix any such minimum; or
  - (ii) in the case of a mortgage, the maximum amount thereof, if it is intended to fix any such maximum;
- (b) the place where the power is to be exercised, or, if no place is specified, a declaration that the power may be exercised anywhere, subject to this Act;
- (c) the limit of time within which the power may be exercised.

(3) Subject to section 67(1), in the case of an application to dispose of a ship by way of sale, the Registrar shall enable any such applicant to dispose of the ship or share in the manner desired in accordance with subsection (4).

(4) On receiving an application made under this section, the Registrar shall enter in the register book a statement of the particulars set forth in the application, and shall grant to the applicant a Certificate of Sale or a Certificate of Mortgage, as the case may require.

- (5) A Certificate of Sale and a Certificate of Mortgage—
- (a) shall each be in the prescribed form;
  - (b) shall not authorise any sale or mortgage to be made in Trinidad and Tobago, or by any person not named in the certificate; and
  - (c) shall contain a statement of the particulars set forth in the application, and also a statement of any registered mortgages and certificates of sale or mortgage affecting the ship or share in respect of which the certificate is given.

General rules  
for Certificates  
of Sale.

**67.** (1) A Certificate of Sale shall not be granted except for the sale of an entire ship; and such a certificate shall not be granted under this Part, except upon the application, made by declaration in writing of all persons appearing on the register to be interested therein, as owners or mortgagees.

(2) The power conferred by any such certificate shall be exercised in conformity with the directions contained therein.

(3) An agreement for sale entered into in good faith in exercise of the power conferred by any such certificate to a purchaser for valuable consideration shall not be impeached by reason of the person by whom the power was given dying at any time between the giving of the power and the completion of the sale.

(4) Whenever any such certificate contains a specification of the place at which, and a limit of time not exceeding twelve months within which the power is to be exercised, a sale made in good faith to a purchaser for valuable consideration without notice shall not be impeached by reason of the bankruptcy of the person by whom the power was given.

Procedure  
where ship  
under  
Certificate of  
Sale granted in  
Trinidad and  
Tobago.

**68.** (1) Where a Trinidad and Tobago ship is sold, in exercise of a power conferred by a Certificate of Sale granted under this Part, to persons qualified to own a Trinidad and Tobago ship—

- (a) a transfer of the ship shall be made by Bill of Sale in the manner provided by this Part; and the

Bill of Sale, when duly executed, and the Certificate of Sale shall be produced to a proper officer at the place at which the ship is sold, and that officer shall thereupon endorse and sign on the certificate of sale a statement of the fact of that ship having been sold, and shall forthwith notify the Registrar;

- (b) the ship may be registered anew in the manner provided by this Act; and
- (c) the Registrar upon receipt of the Certificate of Sale and the ship's Certificate of Registry from a proper officer each of those certificates having endorsed thereon an entry of the fact of the sale having taken place, shall thereupon enter the sale of the ship in the register book.

(2) Where a Trinidad and Tobago ship is sold in exercise of a power conferred by a Certificate of Sale, granted under this Part, to persons not qualified to own a Trinidad and Tobago ship—

- (a) the Certificate of Sale and the Certificate of Registry shall be produced to the proper officer at the place at which the ship is sold, and he shall retain those certificates, and shall endorse and sign on each of them a statement of the fact of that ship having been sold to persons not qualified to own a Trinidad and Tobago ship;
- (b) the proper officer making the endorsements required by paragraph (a) shall forward the Certificates of Sale and Registry, each being duly endorsed, to the Registrar;
- (c) the Registrar, upon receipt of the Certificates of Sale and Registry, each being endorsed in accordance with paragraphs (a) and (b), shall make an entry of the sale in his register book, and the registration of the ship shall be considered as closed, except as far as relates to any unsatisfied mortgages or existing certificates of mortgage entered therein; and

(d) where default is made in the production of the certificates mentioned in this subsection, the persons to whom the ship is sold shall be considered to have acquired no title to or interest in, the ship, and the person on whose application the Certificate of Sale was granted, and the person exercising the powers conferred thereby, are each guilty of an offence.

(3) Where no agreement for sale is entered into in exercise of the powers conferred by a Certificate of Sale granted under this Part, that certificate shall be delivered to the Registrar, and the Registrar shall thereupon cancel the certificate, and shall enter the fact of the cancellation in the register book; and every certificate so cancelled shall be void.

Registry in  
Trinidad and  
Tobago where  
ship sold under  
Certificate of  
Sale granted in  
a foreign State.

**69.** (1) Where any ship registered in a foreign State is sold in exercise of a power conferred by a Certificate of Sale granted under the law of that country, to persons qualified to own a Trinidad and Tobago ship, that ship may be registered in Trinidad and Tobago in accordance with this section.

(2) Application for registry anew shall be made to the Registrar and there shall be produced to the Registrar the Bill of Sale by which the ship is transferred, the Certificate of Sale and the Certificate of Registry of the ship.

(3) The Registrar, on registering the ship anew—

(a) shall retain the Certificates of Sale and Registry, and shall endorse on each of those certificates an entry of the fact of a sale having taken place; and shall forward those certificates, so endorsed, to the Registrar at the ship's former Port of Registry; and

(b) shall enter in the register book such particulars as are, by this Act required to be entered therein in the case of the first registry of a ship in Trinidad and Tobago, and also a statement of any registered mortgages or certificates of mortgage enumerated on the Certificate of Sale.

- (4) On such registry anew—
- (a) the description of the ship contained in her former Certificate of Registry may be transferred to the new register book, without her being resurveyed, and the declaration to be made by the purchaser shall be the same as would be required to be made by an ordinary transferee; and
  - (b) all persons appearing on the register to be interested in that ship as owners or mortgagees shall be deemed to have the same rights, and their rights shall be determined in the same manner, as if that ship had been first registered in Trinidad and Tobago in the manner provided in this Act and as if any unsatisfied mortgages or existing certificates of mortgage had been entered in the register book at that port.

**70.** The following rules shall be observed as to certificates of mortgage:

Rules as to certificates of mortgage.

- (a) the power shall be exercised in conformity with the directions contained in the certificates;
- (b) every mortgage executed thereunder shall be registered by the endorsement of a record thereof on the certificate by the proper officer at the place at which the mortgage is executed;
- (c) a mortgage executed in good faith thereunder shall not be impeached by reason of the person by whom the power was given dying at any time between the giving of the power and the execution of the mortgage;
- (d) whenever the certificate contains a specification of the place at which, and a limit at time not exceeding twelve months within which, the power is to be exercised, a mortgage executed in good faith to a mortgagee without notice shall not be impeached by reason of the bankruptcy of the person by whom the power was given;

- (e) every mortgage which is so registered as aforesaid on the certificate shall have priority over all mortgages of the same ship or share created subsequently to the date of the entry of the certificate in the register book; and where there are more mortgages than one so registered, the respective mortgagees claiming thereunder shall, notwithstanding any express, implied or constructive notice, be entitled one before the other according to the date and time that each mortgage is registered on the certificate, and not according to the date of the mortgage;
- (f) subject to the foregoing rules, every mortgagee whose mortgage is registered on the certificate shall have the same rights and powers, and be subject to the same liabilities, as he would have had and been subject to, if his mortgage had been registered in the register book instead of on the certificate;
- (g) the discharge of any mortgage so registered on the certificate may be endorsed on the certificate by the Registrar or proper officer on the production of such evidence as is, by this Act required to be produced to the Registrar for the entry of the discharge of a mortgage in the register book; and, on that endorsement being made the interest, if any, which passed to the mortgagee shall vest in the same person or persons in whom it would, having regard to the intervening acts and circumstances, if any, have vested if the mortgage had not been made;
- (h) on the delivery of any certificate of mortgage to the Registrar by whom it was granted, he shall, after recording in the register book, in such manner as to preserve its priority, any unsatisfied mortgage registered thereon, cancel the certificate and enter the fact of the cancellation in the register book; and every certificate so cancelled shall be void.

**71.** On proof at any time to the satisfaction of the Registrar that a Certificate of Sale or mortgage is lost or destroyed, or so damaged as to be useless, and that the powers thereby given have never been exercised, or, if they have been exercised, then, on proof of the several matters and things that have been done thereunder, the Registrar may as circumstances require, either issue a new certificate or direct such entries to be made in the register book, or such other things to be done, as might have been made or done if the loss, destruction or damage had not taken place.

Loss of Certificate of Sale or mortgage.

**72.** (1) The owner of a Trinidad and Tobago ship, or a share therein, in respect of which a Certificate of Sale or Mortgage has been granted specifying the places where the power thereby given is to be exercised, may, by an instrument under his hand, authorise the Registrar by whom the certificate was granted to give notice to the proper officer at every such place that the certificate is revoked.

Revocation of Certificate of Sale or mortgage.

(2) Notice shall thereupon be given accordingly and be recorded by the proper officer receiving it, and after it is recorded, the certificate shall be deemed to be revoked in respect of any sale or mortgage to be thereafter made at that place.

(3) After it has been recorded, the notice shall be exhibited to every person applying for the purpose of effecting or obtaining a transfer or mortgage under the certificate.

(4) A proper officer, on recording any such notice, shall inform the Registrar by whom the certificate was granted whether any previous exercise of the power to which the certificate refers has taken place.

#### MARITIME LIENS

**73.** The rules, legal and equitable, applicable to maritime and other liens on ships, cargo and other maritime property at present in operation in Trinidad and Tobago shall continue in force except so far as they are inconsistent with the provisions of this Act.

Application of law and equity.

#### PART VI

#### MISCELLANEOUS

**74.** Where by reason of infancy, mental illness or defect or any other cause, any person interested in a ship or share therein is incapable of making any declaration or doing any act required or

Provision for cases of infancy and other disability.

permitted by this Act to be made or done in connection with the registry of the ship, or any share therein, the legal guardian or representative of that person, or the committee, manager or other administrator of his estate, or if there is no such guardian, representative, committee, manager or administrator, any person appointed by any Court of competent jurisdiction on application made on behalf of the incapable person or of any other person interested, may make that declaration, or a declaration as nearly corresponding thereto as circumstances permit, and do that act in the name and on behalf of the incapable person; and all acts done by the substitute shall be as effectual as if done by the person for whom he is substituted.

Notice of trusts  
net received.

**75.** (1) No notice of any trust, express, implied or constructive, shall be entered in the register book or be receivable by the Registrar.

(2) Subject to the provisions of this Act, and subject to any rights and powers appearing by the register book to be vested in any other person, the registered owner of a Trinidad and Tobago ship, or any share therein, shall have power absolutely to dispose, in the manner provided in this Act of the ship or share, and to give effectual receipts for any money paid or advanced by way of consideration.

Equities net  
excluded by  
Act.

**76.** In this Part, “beneficial interest” includes interests arising under contract or other equitable interests; and accordingly, without prejudice to—

- (a) the provisions of this Act for preventing notice of trusts from being entered in the register book or received by the Registrar;
- (b) the powers of disposition and of giving receipts conferred by this Act on registered owners and mortgagees;
- (c) the provisions of this Act relating to the exclusion of unqualified persons from the ownership of Trinidad and Tobago ships,

interests arising under contract or other equitable interests may be enforced by or against owners and mortgagees of ships in respect of their interest therein in the same manner as in respect of any other personal property.

**77.** Where any person has a beneficial interest otherwise than by way of mortgage, in a Trinidad and Tobago ship or any share therein, and that ship or share is registered in the name of some other person as owner, the person so interested shall, as well as the registered owner, be subject to all pecuniary penalties imposed by this Act or any other written law on the owners of ships or shares therein; so, nevertheless, that proceedings may be taken for the enforcement of any such penalties against both or either of the aforesaid persons, with or without joining the other of them.

Liability of owners.

**78.** The name and address of the managing owner for the time being of every Trinidad and Tobago ship shall be entered in the register book.

Managing owner to be registered.

**79.** Where, under this Act any person is required to make a declaration on behalf of himself or of any corporation, or any evidence is required to be produced to the Registrar, and it is shown to the satisfaction of the Registrar that from any reasonable cause that person is unable to make the declaration, or that the evidence cannot be produced, the Registrar may, on the production of such other evidence, and subject to such terms as he may think fit, dispense with the declaration or evidence.

Power of Registrar to dispense with declarations and other evidence.

**80.** (1) Declarations required by this Act to be made shall be made before a Registrar, or before any person authorised by law to administer oaths.

Mode of making declarations.

(2) Declarations required by this Act may be made on behalf of a corporation by the secretary or any other officer of the corporation authorised by it for the purpose.

**81.** The following documents shall be admissible in evidence:

Admissibility of register as evidence.

- (a) any register book under this Act on its production from the custody of the Registrar or other person having the lawful custody thereof;
- (b) a Certificate of Registry or licence under this Act purporting to be signed by the Registrar or other proper officer;

- (c) an endorsement on a Certificate of Registry or licence purporting to be signed by the Registrar or other proper officer;
- (d) every declaration made under this Act in respect of a Trinidad and Tobago ship.

Forms.

**82.** (1) The several instruments and documents specified in this Act shall be in the prescribed form or as near thereto as circumstances permit.

Schedule.

(2) The Minister may from time to time, make such alterations in the forms so prescribed and also in the forms set out in the Schedule as he may deem requisite, and shall by Notice give due notice of any such alteration.

(3) The Registrar shall not be required, without the special direction of the Minister, to receive and enter in the register book any Bill of Sale, mortgage or other instrument for the disposal or transfer of any ship or share therein, or any interest therein which is made in any form other than the prescribed form or which contains any particulars other than those required in such form.

Instructions to Registrar.

**83.** The Minister may for carrying this Act into effect give such instructions to the Registrar regarding—

- (a) the manner of making entries in the register book;
- (b) the execution and attestation of powers of attorney;
- (c) any evidence required for identifying any person;
- (d) the referring to the Minister of any question involving doubt or difficulty; and generally,
- (e) any act or thing to be done in pursuance of this Act as he thinks fit.

Forgery of documents.

**84.** Every person who forges, fraudulently alters or assists in forging or fraudulently altering, or procures to, be forged or fraudulently altered, any book, builder's certificate, Certificate of Survey, Certificate of Registry, Certificate of Competency, declaration, Bill of Sale, instrument of transfer, instrument of

mortgage or certificate of sale or mortgage under this Act or any entry, or endorsement required by this Act to be made in or on any of those documents is guilty of an offence and is liable to a fine of five thousand dollars and to imprisonment for two years.

**85.** (1) Any person who, in the case of any declaration made in the presence of, or produced to, the Registrar or proper officer under this Act, or in any document or other evidence produced to the Registrar or proper officer—

False  
declarations.

- (a) wilfully makes, or assists in making, or procures to be made, any false statement concerning the title to, or ownership of, or in the interest existing in any ship, or any share in a ship; or
- (b) utters, produces or makes use of any declaration or document containing any such false statement, knowing the same to be false,

is guilty of an offence and is liable to a fine of five thousand dollars and to imprisonment for two years.

(2) Any individual who wilfully makes a false declaration touching the qualification of himself, or of any other individual or corporation to own a Trinidad and Tobago ship, or any share therein is guilty of an offence and is liable to a fine of five thousand dollars and to imprisonment for two years; and that ship or share shall be liable to forfeiture under this Act to the extent of the interest therein of the declarant, and also, unless it is proved that the declaration was made without the authority of any person on behalf of whom the declaration is made.

**86.** (1) Where a ship is subject to forfeiture under this Act an officer may seize and detain the ship and the Minister may apply to the High Court for an order under subsection (2).

Proceedings on  
forfeiture of  
ship.

(2) Upon application being made under subsection (1) the Court may order the ship and its equipment to be forfeited.

(3) Anything forfeited under this section becomes the property of the State and may be sold or otherwise dealt with as the Minister thinks fit.

(4) An officer who seizes and detains a ship pursuant to subsection (1) is not liable for such seizure or detention where the Court, before which a trial relating to the seizure or detention is held, is satisfied that there were reasonable grounds for the seizure or detention, notwithstanding that the ship is not brought in for adjudication or, if so brought in, is declared not liable to forfeiture.

(5) Where the Court, referred to in subsection (4), is satisfied that there were no reasonable grounds for the seizure or detention of a ship, the Court may award costs and damages to any party aggrieved and make such order as it thinks just.

(6) In this section “officer” means—

- (a) any public officer appointed by the Minister in writing signed by him to be an officer for the purposes of this section;
- (b) a police officer;
- (c) a member of the Trinidad and Tobago Defence Force.

## PART VII

### MANNING AND CERTIFICATION

Minister to  
make  
Regulations for  
examinations  
for certification  
of competency.

**87.** (1) Subject to subsection (2) the Minister may make Regulations—

- (a) requiring ships to carry such number of qualified officers of any description, qualified doctors and qualified cooks and such number of other seamen or qualified seamen of any description as may be specified in the Regulations;
- (b) prescribing standards of competency to be attained and other conditions to be satisfied, subject to any exceptions allowed by or under the Regulations, by officers and other seamen of any description in order to be qualified for the purposes of this section; and
- (c) requiring that in any case a ship shall be under the charge of a properly certificated master and that watches at sea and in port are always kept by appropriately qualified officers.

(2) The Minister shall not exercise his power to make Regulations requiring ships to carry seamen other than doctors and cooks except to the extent that it appears to him necessary or expedient in the interests of safety.

(3) Without prejudice to the generality of paragraph (b) of subsection (1) the conditions prescribed under that paragraph may include conditions as to nationality, and regulations made for the purposes of that paragraph may provide for—

- (a) the manner in which the attainment of any standard or the satisfaction of any other condition is to be evidenced;
- (b) the conduct of any examinations, the conditions for admission to them and the appointment and remuneration of examiners;
- (c) the issue, form and recording of certificates and other documents;
- (d) the payment of fees; and
- (e) prescribing the rights and obligations of holders of certificates of competency and the offences for which certificates may be suspended or cancelled.

**88.** The Minister may exempt any ship or class of ship from the requirements of any regulation made under section 87 and such exemption given under this section may be confined to a particular period or to one or more particular voyages.

Power to exempt.

**89.** (1) Where the laws of any other State provide for the examination for, and grant of, certificates to persons intending to act as masters, seamen, officers and engineers on board ships, and the Minister is satisfied that all examinations are so conducted as to be equally effective as the examinations for the same purpose under this Act, the certificates so granted are deemed to be at least equivalent to those granted under this Act.

Recognition of certificates issued abroad.

(2) Where a person holding a certificate referred to in subsection (1) is desirous of serving on a Trinidad and Tobago ship as master, deck officer or engineer, the Minister may direct that—

- (a) where the person is a citizen of Trinidad and Tobago, he be granted a certificate of equivalent grade under this Act;

- (b) where the person is not a citizen of Trinidad and Tobago, he may be issued with a licence, authorising him to serve on a Trinidad and Tobago ship in the same capacity as if his certificate had been granted under this Act,

subject to such conditions as the Minister may impose.

- (3) A licence issued under subsection (2) shall—

- (a) during its currency have the same force as a Certificate of Competency granted under this Act and may be cancelled or suspended for like reason;
- (b) be valid for a period of five years from the date of issue, and may be renewed upon such conditions as may be prescribed.

- (4) The Minister may by Notice from time to time, declare the names of those States to which subsection (1) applies.

Power of the Minister to suspend or cancel.

**90.** (1) Where there has been any allegation of misconduct or contravention of the provisions of this Act by the holder of a Certificate of Competency or licence issued under this Act, the Minister may appoint a board of inquiry to be held by one or more ship's officers or by one or more other persons who, in the opinion of the Minister, are qualified to do so; the members of such a board shall have all the powers of a person holding an inquiry under section 371 and they shall, at the conclusion of their investigation, send a full report of the proceedings and evidence to the Minister who, if it appears to him that the person against whom the allegations were made was guilty of such misconduct or contravention, may suspend or cancel the certificate or licence of that person.

(2) The Minister may also suspend or cancel a Certificate of Competency or licence issued under this Act if the holder is convicted by any Court in Trinidad and Tobago of an offence relating to or connected with shipping matters and in this regard the Minister may also exercise any of the powers granted to him under section 392.

(3) Where in any case a Certificate of Competency or licence is believed on reasonable grounds not to be genuine or is held by some person not entitled to it, any person authorised by this Act on any other written law to peruse the certificate or licence may impound it; and if the certificate or licence is impounded it shall forthwith be sent to the Minister who may, in his discretion, cause such investigations to be made as he thinks fit.

**91.** Any person who, having been engaged in any of the capacities prescribed under this Part in any ship as aforesaid, goes to sea in that capacity without being entitled to, and without being in possession of, the required certificate or licence and any person who employs any person in any of the above-mentioned capacities in such ship without ascertaining that he is entitled to, or possesses, such certificate or licence is guilty of an offence.

Uncertified and unauthorised officers.

**92.** Any person serving in any ship and holding any certificate, licence or other document which is evidence that he is qualified for the purposes of this Part shall, on demand, produce it to the Director or proper officer and if he is not himself the master, to the master of the ship, and where he fails to do so without reasonable cause he is guilty of an offence.

Production of certificates and other documents of qualification.

**93.** Every person who—

- (a) makes, procures to be made or assists in making any false representation for the purpose of obtaining for himself or for any other person any Certificate of Competency or licence;
- (b) forges, assists in forging or procures to be forged or fraudulently alters, assists in fraudulently altering or procures to be fraudulently altered, any certificate, licence or any official copy thereof;
- (c) fraudulently lends such a certificate or licence to or allows the same to be used by any other person,

Offences relating to certificate.

is guilty of an offence.

Prohibition  
against  
going to sea  
unmanned.

**94.** Subject to section 88 where a Trinidad and Tobago ship or a foreign ship goes to sea or attempts to go to sea without carrying such officers and other seamen as it is required to carry under this Act or the laws of the flag State as the case may be, it may—

- (a) in either case be detained; and
- (b) in the case of a Trinidad and Tobago ship, the owner or master is guilty of an offence and is liable to a fine of five thousand dollars.

Ship leaving  
without  
clearance.

**95.** If any ship leaves or attempts to leave any port in Trinidad and Tobago while under detention under this Part, the master thereof is guilty of an offence and is liable to a fine of fifteen thousand dollars.

#### PART VIII

#### ENGAGEMENT OF SEAMEN

Registrar of  
Seamen.

**96.** The Director shall be the Registrar of Seamen.

Functions.

**97.** The functions of the Registrar of Seamen are:

- (a) to conduct all business connected with the engagement and discharge of all persons who serve on board Trinidad and Tobago ships and all seamen being citizens of Trinidad and Tobago who serve on foreign ships;
- (b) to afford facilities for engaging and discharging seamen by keeping registers of the names and conduct of—
  - (i) seamen who apply to him for engagement;
  - (ii) seamen shipped or discharged by him;
  - (iii) seamen who produce continuous discharge certificates in proof of service in foreign or Trinidad and Tobago ships;
  - (iv) seamen who serve in Trinidad and Tobago ships.
- (c) to cause copies of the certificates referred to in paragraph (b)(iii) to be kept at his office;

- (d) to perform such other duties relating to seamen, apprentices and merchant ships as are by or in pursuance of this or any other written law relating to merchant shipping entrusted to him.

**98.** (1) Subject to subsection (2) the master of every Trinidad and Tobago ship shall enter into an agreement in accordance with this Act with every seaman whom he engages and carries to sea as one of his crew, and the master of any ship shall enter into such an agreement with every seaman whom he engages in Trinidad and Tobago or carries to sea from Trinidad and Tobago as one of his crew. Crew agreements.

(2) Subsection (1) shall not apply in any case where the ship concerned does not exceed twenty-four metres, and which is not engaged on an international voyage.

(3) The Minister may waive the requirements stipulated in subsection (1), or he may vary the contents of the approved form of the crew agreement in respect of any ship if he considers it expedient to do so.

(4) The Minister may make Regulations for the engagement of seamen and matters pertaining to the engagement of seamen in respect of vessels under twenty-four metres and which are not engaged on an international voyage.

**99.** (1) A crew agreement shall be in the prescribed form and shall be dated at the time of the first signature thereof, and shall be signed by the master before a seaman signs his name. Contents of crew agreement.

(2) The crew agreement shall show the place at which it is made, the surname and other names of the seaman, his birthplace, and his age or date of his birth, and shall state clearly the respective rights and obligations of each of the parties, and shall contain as terms thereof the following particulars:

- (a) the name of the ship in which the seaman undertakes to serve;
- (b) either the nature and, as far as is practicable, the duration of the intended voyage or engagement,

or the maximum period of the voyage or engagement, which shall not exceed twelve months, and the port at which it is intended the crew shall be discharged, and the places or ports of the world, if any, to which the voyage or engagement is not to extend;

- (c) the number and description of the crew;
- (d) if possible, the place and date at which each seaman is to be on board or to begin work;
- (e) the capacity in which each seaman is to serve;
- (f) the amount of wages which each seaman is to receive;
- (g) the prescribed scale of the provisions which are to be furnished to seamen;
- (h) the time that is to expire after arrival at the port of discharge before the seaman is discharged;
- (i) any Regulations as to conduct on board and as to fines, and other lawful punishment for misconduct which have been made by the Minister and which the parties agree to adopt;
- (j) a list of young persons under the age of eighteen years and the dates of their births.

(3) The crew agreement shall be so drawn up as to admit of such stipulations to be adopted at the will of a master and seaman in each case, whether respecting the advance and allotment of wages or otherwise, as are not contrary to law.

(4) An agreement made to employ a seaman under this section shall be terminated by—

- (a) mutual consent of the parties thereto;
- (b) the death of the seaman; or
- (c) the loss or total unseaworthiness of the ship.

Regulations for disciplinary offences.

**100.** For the purpose of maintaining discipline on board Trinidad and Tobago ships, the Minister may make Regulations for—

- (a) any misconduct on board as a disciplinary offence and enabling the master or such an officer as may be designated by the master to impose fines on seamen committing disciplinary offences;

- (b) the procedure for the hearing of appeals against fines for disciplinary offences;
- (c) the setting up of a disciplinary committee of persons employed in the ships and for the exercise by all or any of those members of the powers of the master in dealing with disciplinary offences;
- (d) the payment of fines for disciplinary offences.

**101.** Where any conduct is both a disciplinary offence and an offence against any of the provisions of this Act, then if it has been dealt with as a disciplinary offence it shall not be dealt with as an offence against that provision. Same offence.

**102.** The following provisions shall have effect with respect to a crew agreement made in the case of ships trading from and beyond the waters of Trinidad and Tobago: Procedures relating to certain crew agreements.

- (a) the agreement shall, subject to the provisions of this Act as to substitutes, be signed by each seaman;
- (b) the Registrar of Seamen shall cause the agreement to be read over and explained to each seaman or otherwise ascertain that each seaman understands the agreement before he signs it and shall attest each signature;
- (c) when the crew is first engaged, the agreement shall be signed in duplicate, and one part shall be forwarded to the owner and the other shall be retained by the master and shall contain a special place or form for the descriptions and signatures of substitutes or persons engaged subsequent to the first departure of the ship;
- (d) where a substitute is engaged in the place of a seaman who duly signed the agreement and whose services are, within twenty-four hours of the ship proceeding to sea, lost by death, desertion or other unforeseen cause, the master shall, before the ship proceeds to sea if practicable, and if not, as soon

as possible afterwards, cause the agreement to be read over and explained to the substitute, and the substitute shall thereupon sign the same in the presence of a witness and the witness shall attest the signature;

- (e) an agreement may be made for a voyage or, if the voyage of the ship averages less than six months in duration, may be made to extend over two or more voyages, and an agreement as made to extend over two or more voyages is in this section referred to as a “running agreement”;
- (f) a running agreement shall not extend beyond the twelve months’ period of time next following the date of the making of the agreement or the first arrival of the ship at her port of destination after the termination of that period;
- (g) on every return to the port where the crew was engaged before the final termination of a running agreement, the master shall make on the agreement an endorsement as to the engagement or discharge of seamen, either that no engagements or discharges have been made or are intended to be made before the ship leaves port, or that all those made have been made as required by law, and if the master wilfully makes a false statement in any such endorsement he is guilty of an offence;
- (h) the duplicate crew agreement retained by the owner on the first engagement of the crew shall be kept by the owner for a period of seven years after the expiration of the agreement and shall be produced on demand made therefor by the Registrar of Seamen or other proper officer;
- (i) except as provided in section 118, a crew agreement shall not purport to deprive any Court of its jurisdiction to hear and determine disputes respecting the agreement.

**103.** (1) The master shall, at the commencement of every foreign voyage or engagement, cause a legible copy of the crew agreement omitting the signatures to be displayed in some part of the ship which is accessible to the crew.

Further provisions as to crew agreement.

(2) Every erasure, amendment or alteration in any crew agreement, except additions made for the purpose of shipping substitutes or persons engaged after the first departure of the ship, shall be without effect unless proved to have been made with the consent of all persons interested in the erasure, amendment or alteration.

(3) In any proceedings, a seaman may introduce evidence to prove the contents of any crew agreement or otherwise to support his case without producing or giving notice to produce the agreement or any copy thereof.

(4) Every person who fraudulently alters, makes any false entry in, or delivers a false copy of, any crew agreement is guilty of an offence.

**104.** In no case shall stipulations adopted by the parties be contrary to the laws of the flag State of the ship in matters relating to wages and conditions of employment of seamen and masters on board ships.

Stipulations adopted by the parties not to be contrary to law of flag State.

**105.** (1) Subject to section 160, the master shall sign and give to a seaman discharged from his ship, either on his discharge or on payment of his wages, a certificate of his discharge in an approved form, specifying the period of his service and the time and place of discharge.

Certificate of discharge of seamen.

(2) A Certificate of Discharge under subsection (1) shall not contain any statement as to the wages or the quality of work of the discharged seaman.

(3) The master shall, upon the discharge of every certificated officer whose Certificate of Competency has been delivered to and retained by him, return the certificate to the officer.

Character  
report.

**106.** (1) When a seaman is discharged from a Trinidad and Tobago ship, the master thereof shall make and sign a report in the prescribed form, in this section called a “character report”, in which the master—

- (a) shall report on the conduct, character and qualifications of the seaman who is being discharged; or
- (b) may state that he declines to give any report on the conduct, character and qualifications of the seaman who is being discharged.

(2) The master before whom the discharge of a seaman is being made shall, subject to section 160 and if the seaman so desires, give the seaman a copy of the character report on him.

(3) A person is guilty of an offence who—

- (a) makes a false report of character knowing the same to be false;
- (b) forges or fraudulently alters any certificate of discharge or character report or copy of a character report;
- (c) fraudulently uses any certificate of discharge or character report, that is forged or altered or that does not belong to him.

Discharge on  
change of  
registration.

**107.** Where a Trinidad and Tobago ship ceases to be registered as such, any seaman employed in the ship shall be discharged from the ship, unless he consents in writing to continue his employment in the ship and, in such a case, the provisions of this Part relating to the payment of a seaman’s wages and the power of the Registrar of Seamen or other proper officer to decide disputes about wages shall apply in relation to his wages as if the ship had remained registered in Trinidad and Tobago.

Employment of  
children and  
young persons.  
[3 of 2007].

**108.** (1) No person under the age of sixteen years shall be employed in any Trinidad and Tobago ship, except—

- (a) upon work approved by the Director on board a school-ship or training ship; or

(b) where the Director certifies that he is satisfied, having due regard to the health and physical condition of the person and to the prospective and immediate benefit to him of the employment, that the employment will be beneficial to him.

(1A) Subsection (1) shall apply in any case where a person has not attained the age of sixteen years provided that the work is an integral part of a programme of training on board a ship.

(2) No person under the age of eighteen years shall be employed in any capacity in any Trinidad and Tobago ship unless there has been delivered to the master of the ship a certificate granted by a duly qualified medical practitioner certifying that such person is fit to be employed in that capacity.

(3) Every medical certificate under subsection (2)—

(a) shall be valid for one year from the date of issue, unless earlier revoked; and

(b) may at any time be revoked by a duly qualified medical practitioner if he is satisfied that the young person is no longer fit for work.

(4) No young person under the age of eighteen years shall be employed on work in the engineroom of any ship, unless that young person is an apprentice working under supervision.

(5) This section shall not apply to a ship in which only members of one family are employed.

**109.** (1) The master of every ship trading from and beyond the waters of Trinidad and Tobago shall, before leaving Trinidad and Tobago, sign and send to the Director a full and accurate statement, in the prescribed form of every change which takes place in his crew before finally leaving Trinidad and Tobago and that statement shall be admissible in evidence.

Changes in crew of certain ships.

(2) Any master who without reasonable cause fails to comply with this section is guilty of an offence.

**110.** (1) Where, during the progress of a voyage of a ship, the master is removed, superseded or for any other reason ceases to

Change of master.

have command or charge of the ship, and, is succeeded in the command or charge of the ship, by some other person, he shall deliver to his successor the Certificate of Registry and the various documents relating to the navigation of the ship and to the crew thereof which are in his custody; and if he fails without reasonable cause to do so, he is guilty of an offence.

(2) The successor to every master shall, immediately on assuming the command of a ship, enter in the official log book a list of the documents so delivered to him.

Conditions of service—power of Minister to make Regulations.

**111.** The Minister may make such Regulations as he considers necessary or expedient to provide for—

- (a) the conditions of service of those persons serving in Trinidad and Tobago ships and of Trinidad and Tobago citizens serving in foreign ships;
- (b) matters connected therewith and, in particular, relating to—
  - (i) apprenticeship to sea service;
  - (ii) engagement by foreign ships of nationals of Trinidad and Tobago ships;
  - (iii) the implementation of any international convention relating to the employment, welfare, security, certification or status of officers and seamen;
  - (iv) the avoidance of agreements made contrary to such Regulations as may be prescribed;
  - (v) wages in general, and the rights related thereto of persons employed in Trinidad and Tobago ships, securing safe working conditions, health and welfare for masters and seamen employed in ships;
  - (vi) the accommodation to be provided for officers and seamen on board ships, the position and standard of accommodation and of construction of ships and all questions related to the accommodation of officers and seamen on board; and
- (c) employment of persons under the age of eighteen years.

**112.** (1) Except where otherwise provided in this Act, all correspondence, documents, forms or other writings shall be in the English language, and in the case of the crew agreement, official log book and muster lists, in a prescribed form save that a foreign language version of any document may be appended to the English language version thereof.

Use of English language.

(2) All written signs displayed on board a Trinidad and Tobago ship shall be in the English language with, if it is considered necessary by the master, a foreign language version appended thereto.

**113.** (1) Where in the opinion of the Director the crew of a Trinidad and Tobago ship consists of, or includes persons who may not understand orders given to them in the course of their duty because of their insufficient knowledge of English and the absence of adequate arrangements for transmitting orders in a language of which they have sufficient knowledge, the Director shall inform the master of his opinion and the ship shall not proceed to sea, and may be detained.

Crew's knowledge of English.

(2) If a ship goes to sea or attempts to proceed to sea in contravention of this section both the owner and the master is guilty of an offence.

**114.** The master or owner of a Trinidad and Tobago ship trading from and beyond the waters of Trinidad and Tobago shall pay to each seaman belonging to that ship his wages, if demanded, within two days after the arrival of the ship at the port where the crew is to be discharged or upon the seaman's discharge, whichever first happens.

Time and manner of payment.

**115.** (1) The master of every Trinidad and Tobago ship shall, before paying off or discharging a seaman, deliver at the time and in the manner provided by this Act a full and true account of the seaman's wages and of all deductions to be made therefrom for any reasons whatever.

Master to deliver account of wages.

(2) The account shall be delivered to the seaman not less than twenty-four hours before his discharge or paying off.

Deductions.

**116.** (1) A deduction from the wages of a seaman shall not be allowed unless it is included in the account delivered in pursuance of section 186, except in respect of a matter happening after the delivery.

(2) The master shall, during the voyage, enter the various matters in respect of which the deductions are made with the amount of the respective deductions as they occur in a book kept for that purpose, and shall if required produce the book at the time of the payment of wages and also upon the hearing before any competent authority of any complaint or question relating to that payment.

Settlement of wages.

**117.** (1) When a seaman is discharged, and the settlement of his wages completed, he shall sign a release, in an approved form, of all claims in respect of the past voyage or engagement; and the release shall be signed by the master or owner of the ship.

(2) The release, so signed and attested, shall operate as a mutual discharge and settlement of all demands between the parties thereto in respect of the past voyage or engagement.

(3) The release shall be delivered to and retained by the owner for a period of seven years after the expiration of the agreement and shall be produced on demand made therefor by the Registrar of Seamen or other proper officer.

Registrar's decision as to wages.

**118.** Where a question, of whatever nature and whatever the amount in dispute, between a master or owner and any of his crew is raised before the Registrar of Seamen and both parties agree in writing to submit the same to him, the Registrar, shall hear and decide the question so submitted; and an award made by him on the submission shall be conclusive as to the rights of the parties; and a document purporting to be the submission of the award shall be admissible in evidence in the manner provided by this Act.

Registrar may require ship's papers.

**119.** (1) In any proceeding under this Act before the Registrar relating to wages, claims or discharge of a seaman, the Registrar of Seamen may require the owner or his agent or the master or any mate or other member of the crew to produce any log books or

other documents in his possession or power relating to a matter in question in the proceedings and may require the attendance of and may examine any of those persons who are then at or near the place on the matter, and may administer oaths.

(2) In any proceedings under this Act before the Registrar of Seamen relating to the wages, claims or disputes or discharge of seamen, all travelling and other expenses incurred by the Registrar shall be met by the owner or master of the ship in dispute.

**120.** Where a seaman has agreed with the master of a Trinidad and Tobago ship for payment of his wages or any part thereof in a specific currency, any payment of or on account of his wages if made in any other currency than that stated in the agreement shall, notwithstanding anything in the agreement, be made at the rate of exchange for the amount stated in the agreement for the time being current at the place where the payment is made, and such rate of exchange shall be endorsed on the agreement by a proper officer at that place.

Rate of exchange.

**121.** Where, before the Registrar of Seamen or a proper officer, a question as to wages is raised between the master or owner of a ship and a seaman, and the amount does not exceed five hundred dollars, the Registrar or a proper officer may, on the application of either party, decide the question and the decision shall be final; but if the Registrar or a proper officer is of the opinion that the question is one which ought to be decided by a Court, he may refuse to decide it.

Power of Registrar of Seamen or proper officer to decide disputes about wages.

**122.** In any proceedings by the master of a ship or person employed in a ship otherwise than under a crew agreement for the recovery of any sum due to him as wages, the Court, unless it appears to it that the delay in paying the sum was due to a mistake, to a reasonable dispute as to liability or to the act or default of the person claiming the amount or to any other cause not being the wrongful act or default of the person liable to make the payment or their servants or agents, may order them to pay, in addition to the sum due, interest on it at the rate of twenty per cent per annum or such lower rate as the Court may specify, for the period beginning seven days after the sum became due and ending when the sum is paid.

Power of Court to award interest on wages due otherwise than under crew agreement.

Allotment notes.

**123.** (1) Subject to this section, a seaman may, by means of an allotment note issued in accordance with Regulations, allot a part of the wages to which he will become entitled in the course of his employment in a Trinidad and Tobago ship.

(2) The Minister may make Regulations—

- (a) relating to the limitations to which a seaman's right to make an allotment are subject;
- (b) prescribing the form of allotment notes;
- (c) relating to the right of a person named in an allotment note to sue in his own name.

Wages where service terminated.

**124.** (1) Where the service of a seaman terminates before the date contemplated in the agreement by reason of his being left on shore at a place abroad by reason of his unfitness or inability to proceed on the voyage, such seaman shall be entitled to wages for time served up to such termination but not for any further period.

(2) Where the service of a seaman terminates before the date contemplated in his agreement by reason of the loss or foundering of the ship on which he is employed, he shall be entitled to receive wages in respect of each day on which he is in fact unemployed during a period of two months from the date of termination of the service at the rate to which he was entitled at that date, except so far as he obtains other suitable employment.

Protection of certain rights and remedies.

**125.** (1) A seaman's lien on a ship, his remedies for the recovery of his wages, his right to wages in case of the wreck or loss of the seaman's ship, and any right he may have or obtain in the nature of salvage shall not be capable of being renounced by any agreement.

(2) Any stipulation in any agreement inconsistent with subsection (1) or any other provision of this Act shall be void.

(3) Subsection (1) does not affect any term of an agreement made with the seamen belonging to a ship which, in accordance with the agreement, is to be employed on salvage service which then relates to the remuneration to be paid to them for salvage services rendered by that ship.

**126.** (1) Where, during a seaman's employment in a ship, expenses are incurred by a public officer for the benefit of any of his dependants and the expenses are of a kind specified in the Regulations made and such further conditions, as may be so specified are satisfied, the public officer may by notice in writing require the persons employing the seaman—

Claims against seaman's wages for maintenance.

- (a) to retain for a period specified in the notice such proportion of his net wages as may be so specified; and
- (b) to give to the public officer as soon as may be notice in writing of the seaman's discharge from the ship,

and the persons employing the seaman shall comply with the notice, subject to subsection (3), and give notice in writing of its contents to the seaman.

(2) For the purposes of this section—

- (a) the following persons, and no others, shall be taken to be a seaman's dependants, that is to say, his spouse and any person under the age of sixteen years, whom he is liable, for the purposes of any written law, to maintain or in respect of whom he is liable under such written law to make contributions to a local authority; and
- (b) expenses incurred for the benefit of any person include in addition to any payments made to him or on his behalf, expenses incurred for providing him with accommodation or care or for exercising supervision over him, but no expenses shall be specified in the Regulations unless they are such that a Magistrate's Court has power under any enactment in force in any part of Trinidad and Tobago to order the making of payments in respect thereof.

(3) No more than the following proportion of a seaman's net wages shall be retained under subsection (1) whether in pursuance of one or more notices that is to say:

- (a) one-half, if the notice or notices relate to one dependant only;

(b) two-thirds, if the notice or notices relate to two or more dependants.

(4) Where a public officer has served a notice under this section on the persons employing a seaman, a Magistrate's Court may, on the application of the officer, make an order for the payment to the officer of such sum, not exceeding the proportion of the seaman's wages which those persons were required by virtue of this section to retain as the Court, having regard to the expenses incurred by the officer and the seaman's means, thinks fit.

(5) Any sums paid out of a seaman's wages in pursuance of an order under this section shall be deemed to be paid to him in respect of his wages; and the service, on the persons who employed the seaman, of such an order or of an order dismissing an application for such an order shall terminate the period for which they were required to retain the wages.

(6) An application for an order under this section for the payment of any sum by the persons who employed a seaman shall be deemed, for the purposes of any proceedings, to be an application for an order against the seaman; but the order, when served on those persons, shall have effect as an order against them and may be enforced accordingly.

(7) Any notice or order under this section may be served by registered post.

- (8) The Minister may make Regulations specifying—
- (a) the expenses in respect of which a notice may be served by a public officer under subsection (1);
  - (b) any conditions that must be satisfied if such a notice is to be served;
  - (c) the period that may be specified in such a notice being a period beginning with the service of the notice and ending a specified number of days after the seaman's discharge from his ship;
  - (d) the form of such a notice and the information to be contained therein;

- (e) the amounts to be deducted from a seaman's wages in computing his net wages for the purposes of this section, and the amounts specified under this paragraph may include amounts allotted by allotment notes issued under section 123.

**127.** (1) The master of a Trinidad and Tobago ship, so far as circumstances permit, shall have the same rights, liens and remedies for the recovery of his wages as a seaman has for his wages under this Act or any law.

Remedies of master for remuneration and disbursements.

(2) The master of a Trinidad and Tobago ship, and every person lawfully acting as master of a ship by reason of the death or incapacity from illness of the master of the ship, so far as circumstances permit, has the same rights, liens and remedies for the recovery of disbursements or liabilities properly made or incurred by him on account of the ship as a master has for the recovery of his wages.

(3) Where, in any proceedings regarding the claim of a master in respect of wages or of the disbursements or liabilities mentioned in subsection (2), any rights of set-off or counter-claim is set up, the Court may enter into and adjudicate upon all questions and settle all accounts then arising or outstanding and unsettled between the parties to the proceedings, and may direct payment of any balance found to be due.

**128.** (1) The right to wages shall not depend on the earning of freight, and every seaman and apprentice who would be entitled to demand and recover any wages if the ship in which he has served had earned freight, shall, subject to all other rules of law and conditions applicable to the case, be entitled to demand and recover the same notwithstanding that the freight has not been earned; but in the event of wreck, or loss of the ship, proof that the seaman has not exerted himself to the utmost to save the ship, cargo and stores, shall bar his claim for wages.

Wages not to depend on freight.

(2) Where a seaman or apprentice who would, but for death, be entitled by virtue of this section to demand and recover any wages, dies before the wages are paid, they shall be paid and applied in the same way as the wages of a seaman who dies during a voyage.

Refusal to work. **129.** A seaman shall not be entitled to wages for any time during which he unlawfully refuses or neglects to work when required, whether before or after the time fixed by the agreement for him to begin work, or for any period during which he is lawfully imprisoned for any offence committed by him, unless the Court hearing the case otherwise directs.

Illness caused by own default. **130.** (1) Where a seaman is, by reason of illness, incapable of performing his duty, and it is proved that the illness had been caused by his own wilful act or default, or is a sickness or infirmity wilfully concealed at the time of engagement, he shall not be entitled to wages for the period during which he is, by reason of the illness, incapable of performing his duty.

(2) Subsection (1) does not affect the right of any seaman to any payment or other benefits to which he may be entitled under any law providing for compensation to injured or sick workers.

Costs of procuring conviction. **131.** When in any proceedings relating to a seaman's wages it is shown that the seaman has, in the course of the voyage, been convicted of an offence and punished by imprisonment or otherwise, the Court hearing the case may direct any part of the wages due to the seaman, not exceeding one month's wages, to be applied in reimbursing any costs properly incurred by the master in procuring the conviction and punishment.

Improper discharge. **132.** Where a seaman who has signed an agreement is discharged otherwise than in accordance with the terms of the agreement—

- (a) before the commencement of the voyage; or
- (b) before one month's wages are earned,

without fault and without his consent, he is entitled to receive from the master or owner, in addition to any wages he might have earned, due compensation for the damage caused to him by the discharge, not exceeding one month's wages; and he may recover that compensation as if it were wages duly earned.

**133.** (1) The following provisions apply to wages due or accruing to a seaman: Protection of wages.

- (a) wages are not subject to attachment by any Court;
- (b) an assignment or sale of wages before they are due does not bind the person making it;
- (c) no power of attorney or authority for the receipt of wages is irrevocable; and
- (d) a payment of wages to a seaman is valid in law notwithstanding that the wages have been sold, assigned, attached or encumbered.

(2) Nothing in subsection (1) affects the provisions of this Act with respect to allotment notes.

(3) Nothing in this section applies to any disposition relating to the application of wages—

- (a) in the payment of contributions to a fund declared by Regulations to be a fund to which this section applies;
- (b) in the payment of contributions in respect of the membership of a body declared by Regulations to be a body to which this section applies.

#### ANNUAL LEAVE AND PUBLIC HOLIDAYS

**134.** (1) Every person is entitled after twelve months of continuous service on a Trinidad and Tobago ship, or for the same employer, to an annual leave with pay, or to a proportionate part of the annual leave with pay, the duration of which shall be— Leave and holidays.

- (a) in the case of master and officers, not less than eighteen working days; and
- (b) in the case of other members of the crew, not less than twelve working days.

(2) For the purpose of calculating the time at which annual leave is due—

- (a) periods between consecutive crew agreements shall be included in the reckoning of continuous service referred to in subsection (1);

- (b) short interruptions of service not due to the act or fault of the employee and not exceeding a total of six weeks in any twelve months do not break the continuity of the periods of service that precede and follow them; and
  - (c) continuity of service is not interrupted by any change in the management or ownership of the ships in which the person concerned has served.
- (3) The following shall not be included in annual leave with pay:
  - (a) interruptions of service due to sickness or injury; and
  - (b) public holidays.
- (4) In addition to the entitlement under subsection (1), every member of the crew of a Trinidad and Tobago ship is entitled to nine days annual leave with pay in lieu of public holidays; and if the length of continuous service is less than twelve months, then the annual leave with pay shall be pro-rated.

#### MODE OF RECOVERING WAGES

Seaman may sue for wages.

**135.** (1) Subject to section 125, a seaman or apprentice, or a person duly authorised on his behalf, may, as soon as any wages due to him become payable, sue for them in a Court having jurisdiction in the place at which his service has terminated or at which he has been discharged, or at which any master or owner or other person upon whom the claim is made, resides.

(2) A Court upon complaint on oath made to it for the purposes of proceedings under this section may summon the master or owner or other person to appear before the Court to answer the complaint.

(3) Upon the appearance of the master or owner or other person, the Court may examine upon oath the parties and their respective witnesses regarding the complaint and the amount of wages due, and may make such order for the payment of any wages found due as appears reasonable and just.

(4) Where a master or owner or other person does not appear, the Court, on due proof that the master or owner or other person was duly summoned, may examine on oath the complainant and his witnesses regarding the complaint and the amount of wages due, and may make such order for the payment of any wages found due as appears reasonable and just.

(5) Where an order under this section for the payment of the wages is not obeyed within twenty-four hours after the making thereof, the Magistrate may issue a warrant to levy the amount of the wages awarded to be due by distress and sale of the goods and chattels of the person on whom the order is made together with all the charges and expenses incurred in connection with the distress and levy and the enforcement of the order.

(6) Where sufficient distress cannot be found the Court may cause the amount of the wages, charges and expenses to be levied on the ship in respect of which the wages were earned or on the tackle and apparel thereof, save that if the ship is not within the jurisdiction of the Court, no levy may be made on the ship but the Court may cause the person upon whom the order for payment is made to be arrested and committed to prison for a term not exceeding three months.

**136.** The High Court has no jurisdiction to hear or determine any action, suit or proceeding instituted by or on behalf of any seaman or apprentice for the recovery of wages, except where—

Jurisdiction of High Court limited.

- (a) the owner of the ship is bankrupt;
- (b) the ship is under arrest or is sold by the authority of the High Court; or
- (c) a Magistrate's Court refers the claim to the High Court.

**137.** (1) Where proceedings are instituted in a Court in relation to a dispute between an owner or master of a ship and a seaman, arising out of or incidental to their relation as such, or is instituted for the purpose of this section, the Court may, if, having regard to all the circumstances it thinks it just to do so, rescind any contract between the owner or master and the seaman, or any contract or articles of apprenticeship, upon such terms as the Court thinks just.

Power to rescind contracts.

(2) The jurisdiction of a Court under subsection (1) is in addition to any other jurisdiction that the Court can exercise independently of this section.

**PROPERTY OF DECEASED SEAMAN**

Property of  
deceased  
seaman.

**138.** (1) Where any seaman belonging to a Trinidad and Tobago ship dies during a voyage, the master of the ship shall take charge of any money or effects belonging to the deceased seaman that are on board the ship.

(2) The master shall enter in the official log book—

- (a) a statement of the amount of the money and a description of the effects; and
- (b) a statement of the wages due to the deceased, the amount of deductions, if any, to be made from the wages and the balance of the wages due.

(3) The entry shall be signed by the master and attested by a mate or some other member of the crew.

(4) The master, if he thinks fit, may cause any of the effects of a deceased seaman to be sold.

(5) The master of the ship shall without delay furnish the Registrar of Seamen with a statement of the property of the deceased seaman.

(6) The money, effects and balance of wages mentioned in subsections (1) to (3) and the proceeds of the sale mentioned in subsection (4) are in this Act referred to as the “property of the seaman”.

Delivery of the  
property.

**139.** (1) Subject to subsection (2), the property of the seaman shall be delivered, by the master of a ship by the most practicable means, to the personal representative of the deceased; or, if there is no personal representative, the master shall deliver the property of the seaman to the Registrar of Seamen or to the proper officer as the case may be, for disposal—

- (a) in accordance with the law for determining the distribution or succession of personal property of deceased persons of the place in which the deceased was last resident; or

(b) in accordance with the order of a Court having jurisdiction to determine the distribution of the property of the deceased.

(2) A master may deduct from the property of the seaman any expenses properly incurred in complying with subsection (1).

(3) After complying with subsection (1), the master shall deliver a statement of account to the Registrar of Seamen respecting the property of the seaman.

**140.** A person is guilty of an offence, who for the purpose of obtaining, either for himself or for any other person, any property of the seaman—

Forgery of document.

- (a) forges or fraudulently alters any document purporting to show or assist in showing any right to that property;
- (b) makes use of any document that has been forged or fraudulently altered as described in paragraph (a);
- (c) gives or assists in giving or procures to be given any false evidence knowing the same to be false;
- (d) makes any false representation knowing the same to be false; or
- (e) assists in procuring any false evidence or representation to be given or made knowing the same to be false.

#### OCCUPATIONAL SAFETY, PROVISIONS, HEALTH AND WELFARE

**141.** (1) The Minister may make Regulations for securing, as far as is practicable, safe working conditions and safe means of access for masters and seamen employed in Trinidad and Tobago ships, and requiring the reporting of injuries sustained by them.

Occupational safety Regulations.

(2) Without prejudice to the generality of subsection (1), Regulations under this section may—

- (a) require the maintenance, inspection and testing of any equipment and impose conditions on its use;

- (b) require, prohibit, or regulate the use of any material or process;
- (c) require the provision and use of any protective clothing or equipment;
- (d) limit the hours of employment of seamen in any specified, operation or in any specified circumstances;
- (e) make provision for the discharge, by persons appointed from among the persons employed in a ship, of functions in connection with the arrangements to be made under Regulations.

Provisions and water.

**142.** (1) The Minister may also make Regulations requiring such provisions and water to be provided for seamen employed in Trinidad and Tobago ships or any class of ships as may be specified in the Regulations.

(2) The Minister may exempt any ship from any requirement of Regulations made under this section, either generally or in respect of a particular voyage.

(3) Where the provisions of any Regulations made under this section are not complied with in the case of a ship the master or owner is guilty of an offence and is liable to a fine of one thousand dollars unless he proves that the failure to comply was not due to his neglect or default.

(4) Where a person empowered under this Act to inspect the provisions and water to be supplied to the seamen employed in a Trinidad and Tobago ship is not satisfied that they are in accordance with Regulations made under this section the ship, if in Trinidad and Tobago, may be detained.

Complaint as to provisions or water.

**143.** (1) Where three or more members of the crew of a Trinidad and Tobago ship consider that the provisions or water provided for the use of the crew are, at any time, of bad quality or deficient in quantity, they may complain thereof to the Registrar of Seamen or the proper officer or an inspector, who may either examine the provisions or water complained of, or cause them to be examined.

(2) Where the person making an examination under this section finds that the provisions or water are of bad quality or deficient in quantity, he shall communicate that fact in writing to the master of the ship, and if the master does not thereupon provide provisions or water, fit for human consumption he is guilty of an offence.

(3) The person making the examination shall enter a statement of the result of the examination in the official log book and send a report thereof to the Registrar of Seamen, and that report is admissible in evidence in the manner provided by this Act.

(4) Where the person making the examination certifies in his statement that there was no reasonable ground for complaint, each of the complainants is liable to forfeit to the owner out of his wages a sum not exceeding one week's wages.

**144.** (1) If during the voyage of a Trinidad and Tobago ship the allowance of provisions provided for a seaman is less than that prescribed or any of those provisions are of bad quality, the seaman shall receive by way of compensation for the deficiency or bad quality, for so long as it lasts, such amounts as may be prescribed to be paid to him in addition to, and to be recoverable as, wages.

Allowance for short or bad provisions.

(2) Where the deficiency occurred because the provisions could not be procured or supplied in proper quantities and proper equivalent substitutes were supplied in lieu thereof, those circumstances shall be taken into consideration for the purposes of subsection (1) and the compensation reduced or denied accordingly.

**145.** (1) The master of a Trinidad and Tobago ship in which provisions are supplied to the crew shall keep on board proper weights and measures for determining the quantities of the several provisions and articles distributed; and the master shall allow the weights and measures to be used in the presence of a witness at the time of distribution of the provisions and articles whenever any dispute arises about the quantities.

Weights and measures.

(2) A master who fails without reasonable cause to comply with subsection (1), is guilty of an offence.

Medical  
examinations  
and cooking.

**146.** The Minister may make Regulations as appear to him to be necessary—

- (a) for the medical examination of all persons seeking employment in any capacity on board ships and the issue of medical certificates in respect of such persons; and
- (b) for the examination and granting of certificates to persons qualified to be employed as ships' cooks.

Crew  
accommodation.

**147.** (1) The Minister may make Regulations with respect to the crew accommodation to be provided in Trinidad and Tobago ships.

(2) Without prejudice to the generality of subsection (1), Regulations made under this section may, in particular—

- (a) prescribe the minimum space per person which shall be provided by way of sleeping accommodation for seamen and the maximum number of persons by whom a specified part of such sleeping accommodation may be used;
- (b) prescribe the equipment to be provided for the sleeping rooms, wash rooms, mess rooms and galley in a ship;
- (c) regulate the position in the ship in which the crew accommodation or any part thereof may be located and the standards to be observed in the construction, equipment and furnishing of any such accommodation;
- (d) provide for the protection of the crew against injury, condensation, heat, cold and noise on a ship;
- (e) prescribe the water, heating, lighting, ventilation and sanitary facilities to be supplied on a ship;
- (f) require the submission to a surveyor of ships of plans and specifications of any works proposed to be carried out for the purpose of the provision or alteration of any such accommodation and authorise the surveyor to inspect any such works;

- (g) provide for the maintenance and repair of any such accommodation and prohibit or restrict the use of any such accommodation for purposes other than those for which it is designed; and
- (h) provide for the inspection, measuring and marking of crew accommodation on a ship and its certification for the purpose of ascertaining register tonnage.

(3) Regulations made under this section may exempt ships of any description or any ship from any requirements of the Regulations.

(4) Regulations made under this section may require the master of a ship or any officer authorised by him for the purpose to carry out such inspections of the crew accommodation as may be prescribed.

(5) Where the provisions of any Regulations made under this section are contravened in the case of a ship, the owner or master is guilty of an offence and the ship, if in Trinidad and Tobago, may be detained.

(6) In this section “crew accommodation” includes sleeping rooms, mess rooms, sanitary accommodation, storerooms and catering accommodation provided for the use of seamen, but does not include any accommodation which is also used by, or provided for the use of, passengers.

(7) In making Regulations under this section, the Minister shall have due regard to the requirements of the Convention Concerning Crew Accommodation On Board Ship (Revised 1949) of the International Labour Organisation, including any revisions thereof.

**148.** (1) Every Trinidad and Tobago ship of one thousand gross register tons or more trading from and beyond the waters of Trinidad and Tobago shall carry a duly certified ship’s cook. Certified cook.

(2) Where in the opinion of the Minister there is an inadequate supply of certificated ships’ cooks he may exempt a particular ship from the requirements of this section for a specified period.

Scales of  
medical stores.

**149.** (1) The Minister may make Regulations requiring Trinidad and Tobago ships to carry such medicines, medical stores, appliances and books containing instructions and advice, as may be specified in the Regulations.

(2) The owner and master of every ship shall ensure that the ship carries medicines, medical stores, appliances and books in accordance with the scales laid down under subsection (1).

(3) Where an inspector is of the opinion that the medicines, medical stores, appliances and books on a Trinidad and Tobago ship are deficient in quantity or quality or are placed in improper receptacles, he shall give notice thereof in writing to the master, owner or agent of the ship, and the ship may be detained.

Expenses of  
medical  
treatment and  
burial.

**150.** (1) Where the master of, or a seaman belonging to a Trinidad and Tobago ship receives any surgical or medical treatment, or such dental or optical treatment, including the repair or replacement of any appliance, as cannot be postponed without impairing the efficiency of the master or seaman, the reasonable expenses thereof shall be borne by his employer.

(2) Where the master or seaman dies and is buried or cremated outside his State of residence, the expenses of his burial or cremation shall also be borne by his employer.

Medical  
practitioners to  
be carried.

**151.** (1) Every Trinidad and Tobago ship trading from and beyond the waters of Trinidad and Tobago that proceeds from a port with not less than one hundred persons on board shall carry on board as part of her complement a duly qualified medical practitioner.

(2) The owner of a Trinidad and Tobago ship is guilty of an offence and liable to a fine of one hundred dollars in respect of each day of every voyage of the ship on which the ship is in contravention of subsection (1).

(3) For the purpose of subsection (1), “duly qualified medical practitioner” means a person registered or licensed under the Medical Board Act.

Ch. 29:50.

**152.** (1) The Minister may, by Regulations, constitute an advisory board to be called the National Seamen Welfare Board for the purpose of advising him on the measures to be taken for promoting the welfare of seamen.

Welfare of seaman.

(2) Regulations made by the Minister pursuant to subsection (1) may contain such provisions as he may think fit for the proper functioning of the Board.

**153.** (1) Where a seaman while on board a Trinidad and Tobago ship informs the master of the ship that he wishes to make a complaint to a Magistrate, the proper officer or the Registrar of Seamen, against the master or any of the crew, the master shall, as soon as the service of the ship will permit, allow the complainant to go ashore, so that he can make his complaint—

Facilities for making complaints.

(a) if the ship is then at a place where there is a Magistrate, proper officer or the Registrar of Seamen, at that place; or

(b) if the ship is not then at such a place, on its arrival at such a place.

(2) A master of a ship who fails, without reasonable cause, to comply with this section, is guilty of an offence and liable to a fine of one thousand dollars.

#### PROTECTION OF SEAMEN FROM IMPOSITION

**154.** Subject to this Act, an assignment or sale of any salvage payable to a seaman that is made before the salvage accrues does not bind the person making the assignment or sale, and a power of attorney or authority for the receipt of any such salvage may be revoked regardless of its terms.

Assignment and sale of salvage.

**155.** A debt exceeding a prescribed percentage of a seaman's total earnings as indicated in the crew agreement, if incurred by the seaman after he is engaged to serve, is not recoverable until the service agreed for is concluded.

Seamen's debts.

#### PROVISIONS AS TO DISCIPLINE

**156.** (1) The master or any member of the crew of a Trinidad and Tobago ship who by wilful breach or by neglect of duty, or

Endangering life or ship.

by reason of being under the influence of alcohol or drugs—

- (a) does any act tending to cause the immediate loss, destruction or serious damage of the ship, or tending to endanger immediately the life or limb of a person belonging to, or on board, the ship; or
- (b) refuses or omits to do any lawful act proper and requisite to be done by him for preserving the ship from immediate loss, destruction or serious damage, or for preserving any person belonging to or on board the ship, from immediate danger to life or limb,

is guilty of an offence and is liable to a fine of one thousand dollars and to imprisonment for twelve months.

(2) For the purposes of this section “drugs” means narcotics and psychotropic substances as defined in the Narcotic Drugs and Psychotropic Substances Control Act, 1985.

\*37 of 1985.

General offences against discipline.

**157.** (1) Where a seaman or apprentice engaged on a Trinidad and Tobago ship—

- (a) leaves the ship without leave after its arrival at a port and before it is placed in security, he is liable to forfeit out of his wages a sum not exceeding one week’s pay;
- (b) wilfully disobeys any lawful command, he is liable to imprisonment for one month, and to forfeit out of his wages a sum not exceeding two days’ pay;
- (c) continually disobeys any lawful command, or continually and wilfully neglects his duty, he is guilty of an offence and is liable to imprisonment for three months, and to forfeit for every twenty-four hours continued disobedience or neglect either a sum not exceeding two days’ pay or any expenses properly incurred in hiring a substitute;
- (d) assaults the master or any mate or officer of the ship, he is guilty of an offence and is liable to imprisonment for one year;

\* This Act was repealed by section 60 of the Dangerous Drugs Act, Chap. 11:25.

- (e) combines with any of the crews to disobey lawful commands or to neglect duty or to impede the navigation of the ship or the progress of the voyage, he is guilty of an offence and is liable to imprisonment for one year;
- (f) wilfully damages his ship, or dishonestly misappropriates or converts to his own use, or commits criminal breach of trust in respect of, or wilfully damages, any of its stores or cargo, he is guilty of an offence and is liable to imprisonment for one year and to forfeiture out of his wages a sum equal to the loss thereby sustained;
- (g) commits an act of smuggling, whereby loss or damage is occasioned to the master or owner of the ship, is guilty of an offence and is liable to pay to the master or owner a sum sufficient to reimburse the loss or damage and the whole or a proportionate part of wages may be retained in satisfaction or on account of that liability without prejudice to any further remedy;
- (h) aids or procures a person to stow away on his ship, and that person is afterwards convicted of the offence, he is guilty of an offence and is liable to imprisonment for three months, and to pay to the master or owner of the ship a sum sufficient to reimburse the expenses occasioned to that master or owner in respect of the stowaway, and the whole or a proportionate part of his wages may be retained in satisfaction or on account of that liability, without prejudice to any further remedy.

(2) A seaman or an apprentice shall not be guilty of an offence under subsection (1) by reason only of his refusing duty during a lawful strike after his ship has arrived and has been secured in good safety to the satisfaction of the master and the port authority at a port in Trinidad and Tobago.

(3) A forfeit or other payment imposed in respect of an offence under subsection (1) shall not exceed one-half of one month's salary in any one month, and shall leave the seaman a sum which is sufficient for his maintenance and that of his dependants.

Conviction not to affect other remedies.

**158.** Where a seaman lawfully engaged or an apprentice belonging to a Trinidad and Tobago ship—

- (a) deserts from his ship, he is guilty of the offence of desertion and is liable to imprisonment for three months, and in addition he is liable to forfeit all or any part of the effects he leaves on board and the wages which he has then earned and, where the master or owner of the ship has engaged a substitute in his place at a higher rate of wages than the rate at which wages had been stipulated to be paid to him, to satisfy that excess;
- (b) neglects or refuses without reasonable cause to join his ship or to proceed to sea in his ship, or is absent without leave at any time within the period of twenty-four hours immediately before the ship sails for a port either at the commencement or during the progress of a voyage, or is absent at any time without leave and without sufficient reason from his ship or his duty, and the act or omission does not constitute or is not treated by the master as constituting the offence of desertion, he is guilty of the offence of absence without leave and is liable to imprisonment for two months, and in addition is liable to forfeit out of his wages a sum not exceeding two days' pay and in addition for every twenty-four hours of absence either a sum not exceeding six days' pay or any expenses properly incurred in hiring a substitute.

Improper negotiation of advance note.

**159.** (1) Where a seaman belonging to a Trinidad and Tobago ship being lawfully engaged has received under his agreement an advance note, and after negotiating his advance note wilfully or

through misconduct fails to join his ship or deserts therefrom before the note becomes payable, he is guilty of an offence and is liable to a fine of fifty dollars and to imprisonment for two months.

(2) This section shall not limit or otherwise prejudice any remedy, by suit or otherwise—

- (a) of any person in respect of the negotiation of the advance note; or
- (b) which an owner or master would otherwise have for breach of contract.

**160.** Where it is shown to the satisfaction of the Registrar of Seamen that a seaman lawfully engaged in and belonging to a Trinidad and Tobago ship has wilfully or through misconduct failed to join his ship, the Registrar may direct that the seaman's certificate of discharge shall be withheld for such period as he may think fit, and while the seaman's certificate of discharge is so withheld, any person having the custody of the documents may, notwithstanding anything in this Act or any other written law refuse to furnish copies of any of his certificates of discharge or certified extracts of any particulars of service or character.

Certificate of discharge may be withheld.

**161.** Where a seaman on or before being engaged wilfully and fraudulently makes a false statement of the name of his last ship or alleged last ship, or wilfully and fraudulently makes a false statement of his own name, he is guilty of an offence and is liable to a fine of fifty dollars and to imprisonment for two months.

False statement as to last ship or name.

**162.** (1) Where it appears to the Minister that due facilities will be given by the government of a foreign State for apprehending and recovering a seaman who deserts in that State from a Trinidad and Tobago ship, the Minister may, by Order, declare that this section shall apply in the case of such foreign State, subject to any limitations, conditions and qualifications contained in the Order.

Deserter from foreign ships.

(2) Where a seaman or apprentice deserts in Trinidad and Tobago a ship registered in a State to which this section applies, the master of the ship may apply to a Court for assistance in apprehending the deserter, and the Court and its officers shall

give all assistance within their power, and for that purpose the Court may, on information given on oath, issue a warrant for the deserter to be conveyed on board the ship, or delivered to the master or mate of the ship or to the owner of the ship or his agent to be so conveyed.

Proof of  
desertion in  
proceedings for  
forfeiture of  
wages.

**163.** Whenever a question arises whether the wages of a seaman or apprentice are forfeited under this Part for desertion from a Trinidad and Tobago ship, it shall be sufficient for the person attempting to enforce the forfeiture to show that—

- (a) the seaman or apprentice was duly engaged in or belonged to the ship; and
- (b) he left the ship before the completion of the voyage or engagement; and
- (c) an entry of his desertion was duly made in the official log book,

and the desertion shall thereupon be deemed to be proved so far as it relates to any forfeiture of wages under this Part, unless the seaman or apprentice can produce a proper certificate of discharge or can otherwise show to the satisfaction of the Court that he had sufficient reasons for leaving his ship.

Application of  
forfeiture.

**164.** (1) Where any wages or effects are forfeited under this Part for desertion from a ship, the effects may be sold, and the wages or effects or the money arising from sale of the effects shall be applied towards reimbursing the expenses caused by the desertion to the master or owner of the ship, and any balance remaining shall be paid to the Registrar of Seamen.

(2) Where any wages are forfeited under this Part for any cause other than desertion, the forfeiture shall, in the absence of any specific provision to the contrary, be in favour of the master or owner by whom the wages are payable.

Question of  
forfeiture  
decided in suit  
for wages.

**165.** Any question concerning the forfeiture of, or deductions from, the wages of a seaman or apprentice under this Part may be determined in any proceedings instituted with respect to those wages, notwithstanding that the seaman or apprentice has not been prosecuted for the offence that gives rise to the question.

**166.** A fine imposed on a seaman for any act of misconduct for which his agreement imposes the fine, shall be subject to the following:

Deduction of fine from wages.

- (a) on the offender being discharged, and the offence and the entry in the official log book required by this Act to be made in respect thereof being proved to the satisfaction of the Registrar of Seamen or proper officer, the master or owner shall deduct the fine from the wages of the offender; and the fine so deducted shall be paid to the Registrar, and if the master or owner of the ship fails without reasonable cause so to pay the fine he is guilty of an offence;
- (b) an act of misconduct for which a fine is imposed and paid by or deducted from the wages of the seaman shall not be otherwise punished under this Act.

**167.** Where a person by any means whatever persuades a seaman or an apprentice to neglect or refuse to join or proceed to sea in his ship, or to desert his ship, or otherwise to absent himself from his duty, he is guilty of an offence, and is liable to a fine of one thousand dollars.

Persuading seaman to desert, and harbouring deserter.

**168.** (1) Where a person secretes himself and goes to sea in a ship without the consent of either the owner, master, or a mate or of the person in charge of the ship or of any other person entitled to give that consent, he is guilty of an offence and is liable to a fine of five hundred dollars and to imprisonment for three months.

Penalty on stowaways.

(2) Every person who goes to sea in a ship without a consent mentioned in subsection (1) shall, so long as he remains in the ship, be deemed to belong to the ship, and be subject to the same laws for preserving discipline, and to the same fines and punishments for offences constituting or encouraging a breach of discipline, as if he were a member of the crew and had signed the crew agreement.

**169.** (1) The Trade Disputes and Protection of Property Act shall, in so far as it relates to the immunity of persons from legal proceedings for acts committed in contemplation or furtherance of a trade dispute, apply to seamen as it applies to other persons.

Trade disputes involving seamen.  
Ch. 88:03.

(2) Notwithstanding anything in any agreement, a seaman employed in a Trinidad and Tobago ship may terminate his employment in that ship by leaving the ship in contemplation or furtherance of a trade dispute after giving to the master not less than forty-eight hours notice of his intention to do so, and shall not be compelled unless the notice is withdrawn to go to sea in the forty-eight hours following the giving of such a notice; but such a notice shall be of no effect unless at the time it is given the ship is in Trinidad and Tobago and securely moored in a safe berth.

(3) In this section, “trade dispute” means any dispute between employers and seamen, or between seamen and seamen which is connected with the employment or non-employment, or the terms of the employment or with the conditions of labour, of any person.

Offences to be entered in official log book.

**170.** Where on or in respect of a Trinidad and Tobago ship—

- (a) an offence is committed under section 157 or 158; or
- (b) an act of misconduct is committed for which the agreement of the person committing it provides for a fine, and it is intended to enforce the fine—
  - (i) an entry of the offence or act shall be made in the official log book and signed by the master and also by an officer or one of the crew;
  - (ii) the offender, if still in the ship, shall, before the next subsequent arrival of the ship at any port if it is not at a port; or if it is at the time in port, before its departure from port, either be furnished with a copy of the entry or have the same read over distinctly and audibly to him, and may thereupon make such reply thereto as he thinks fit;
  - (iii) a statement that a copy of the entry was so furnished or that the entry was so read over, and in either case the reply, if any, then made by the offender, shall likewise be entered and signed in the manner aforesaid; and

- (iv) in any subsequent legal proceedings, the entries made under this section, shall, if practicable, be produced or proved, and if they are not the Court hearing the case may in its discretion refuse to receive evidence on the offence or act of misconduct.

**RELIEF AND REPATRIATION**

**171.** (1) Except as otherwise provided in this Act, it is an implied term of every agreement entered into for the employment of a seaman in a Trinidad and Tobago ship that, where the agreement terminates at a port other than the port of engagement, the seaman will be returned to a proper return port at the expense of the master or owner of the ship. Repatriation of seaman.

(2) The owner, master or agent of the ship shall make such arrangements as are necessary to defray all expenses incurred for the return of a seaman pursuant to subsection (1).

(3) The responsibility of the owner, master or agent under this section includes an obligation—

- (a) to pay the cost of maintenance and medical treatment that is necessary for the seaman until his arrival at his proper return port; and
- (b) to ensure that the seaman does not become a charge upon the State.

(4) Subsection (1) applies whether an agreement terminates—

- (a) by effluxion of time;
- (b) by an act of the parties;
- (c) by shipwreck;
- (d) by sale of the ship;
- (e) by the inability of the seaman to proceed in the ship by reason of sickness or injury; or
- (f) by any other cause.

**172.** (1) A seaman who has been left behind or discharged from his ship as a result of his— Exception from liability.

- (a) desertion;
- (b) imprisonment; or

- (c) inability to proceed to his ship because of an illness or infirmity that was wilfully concealed at the time of his engagement,

is not entitled to be returned at the expense of the master or owner under section 171.

(2) The owner, master or agent of the ship from which a seaman mentioned in subsection (1) has been left behind or discharged, shall make all arrangements necessary to defray all expenses incurred for the return of the seaman to a proper return port as if the seaman were entitled thereto.

(3) An owner, master or agent may be reimbursed for any expenses incurred pursuant to subsection (2) out of any wages owing to the seaman at the time he left the ship or out of the proceeds from the sale of any of his effects left on board the ship, or where this is not sufficient, the owner, master or agent may be reimbursed by ordinary process of law.

(4) Notwithstanding subsection (1) or (3), the owner, master or agent shall ensure that the seaman does not become a charge upon the State.

Duty of Registrar.

**173.** (1) Where a seaman is to be left behind or discharged from his ship at a port other than his port of engagement, the Registrar of Seamen or proper officer may demand from the owner, master or agent, whether principal or agent, a guarantee for the proper discharge of any obligations imposed by section 171 or 172.

(2) Where a guarantee required under this section is refused the Registrar of Seamen or proper officer may withhold his consent to the discharge of the seaman concerned.

Effect of workman's compensation.

**174.** Where a seaman is eligible to receive and receives medical aid or periodical payments at the expense of his employer under the terms of any written law providing for compensation to injured or sick workers, the receipt thereof—

- (a) removes any right of the seaman to receive medical treatment under section 171, to the extent that he receives that medical aid; and

(b) removes any right of the seaman to receive maintenance under section 171, to the extent and for so long as he receives the periodical payments.

**175.** Sections 171 to 174 apply in respect of a foreign vessel that engages a seaman or apprentice in Trinidad and Tobago; and “owner” in such a case includes any person appointed or nominated by the owner, or the charterer if the vessel is on demise charter, to act as his agent and who was so acting at the time the seaman or apprentice was engaged.

Application to foreign vessels.

**176.** (1) Where a seaman belonging to a Trinidad and Tobago ship is left at a place other than a proper return port, the master of the ship shall, subject to this section and as soon as practicable, enter in the official log book a statement of the effects left on board by the seaman and an account of wages due to him at the time when he was left behind.

Wages and effects of seaman left behind.

(2) On the termination of the voyage during which the seaman was left behind, the master shall furnish to the Registrar of Seamen or proper officer, within forty-eight hours after the arrival of the ship at the port at which the voyage terminates, a delivery account and a retention account.

(3) The master shall, if required by the Registrar of Seamen or proper officer, furnish such vouchers as may be reasonably required to verify the delivery and retention accounts.

(4) The master of a ship shall deliver to the Registrar of Seamen or proper officer, if he will receive them, the effects of a seaman as shown in a delivery account and, subject to any reimbursement allowed under subsection (5), the amount due on account of wages as shown in that account, and the Registrar or proper officer shall give to the master a receipt for any effects or amount so delivered.

(5) The master of a ship is entitled to retain out of the wages any sums shown in a retention account that appear to the Registrar of Seamen or proper officer to be owing or payable to the master of the ship; and for that purpose the Registrar or proper

officer shall allow those sums to be retained by the master out of the amount due on account of wages shown in the delivery account and, so far as that amount is not sufficient, to be raised and paid to the master out of the effects.

(6) Before allowing any sum to be retained or to be raised and paid, the Registrar of Seamen or proper officer may require that evidence be provided by statutory declaration or otherwise that the sums are owing or payable to the master of the ship.

(7) The Registrar of Seamen or proper officer shall deliver the remainder of the wages and effects to such person at such time and in such manner as may be prescribed, and shall render such accounts in respect thereof as the Minister may direct.

(8) In this section—

(a) “delivery account” means an account of the effects and wages of a seaman left behind or owing at the time a seaman leaves or is discharged from the ship; and

(b) “retention account” means an account of any expenses caused to the master or owner of a ship by the absence of a seaman from the ship due to his desertion, neglect to join his ship, or conduct constituting an offence under section 157 or 158, including, in the case of a seaman who is not entitled to be repatriated at the expense of the master or owner of the ship any provision made for the return of the seaman to a proper return port.

Liability of  
master.

**177.** The master of a Trinidad and Tobago ship is not liable for any loss of effects or for any damage to the effects of a seaman left behind or discharged at a port other than his proper return port, if the master proves to the Registrar of Seamen or proper officer that the loss or damage occurred without his neglect or consent after the seaman left his ship.

Liability of  
Government.

**178.** (1) The Government of Trinidad and Tobago is not liable with respect to anything done under section 176, except that, if after the wages or effects of a seaman have been dealt with under

section 176 any legal proceedings are taken by the seaman against the owner, master or agent of the ship, or by the master or owner of the ship against the seaman, in respect of those wages or effects or involving the forfeiture of those wages, the Minister shall, if notice is given to him of the proceedings and a reasonable opportunity afforded him of appearing, comply with any order of the Court made as respect the wages or effects so far as he can do so out of the wages and effects remitted to him in respect of the voyage of the ship.

(2) The Minister is entitled to appear and be heard in any proceedings referred to in subsection (1) or to be represented by any public officer in his Ministry or any other public officer.

(3) The Minister may, if and so far as he thinks fit, meet any claim by a seaman against the owner, master or agent of the ship in respect of any wages or effects dealt with under section 176 although legal proceedings are not actually taken in respect thereof, if the Minister has given notice to the master or owner of the ship and the master or owner of the ship has not given written notice of objection within ten days of the notice being given, and any expense incurred by the Minister under this subsection is recoverable by the State as a civil debt.

(4) For the purpose of this section, any legal proceedings taken or any claim made by a person in whose favour an allotment note has been made are to be treated as proceedings taken or a claim made by the seaman.

**179.** (1) Any sums remitted under section 176 or arising from the sale of effects under that section, and not disposed of in accordance with that section, shall be retained by the State. Payment to Government.

(2) The master of a ship who, without reasonable cause, contravenes subsection (1) or section 176 is guilty of an offence without prejudice to any other liability to which the ship might be subject.

**180.** Section 176 does not apply in the case of an absent seaman where— Non-application of section 176.

(a) the master of a ship satisfies the Registrar of Seamen or proper officer that none of the effects

of the seaman have to his knowledge been left on board the ship and that he has paid all wages due to the seaman;

- (b) the amount of wages earned by the seaman, after taking into account any deduction made in respect of allotments or advances for which provision is made by the crew agreement, appears from the agreement to be less than one hundred dollars;
- (c) the master of the ship satisfies the Registrar or proper officer that the net amount due to the seaman on account of wages, after taking into account any deductions lawfully made in respect of allotments, advances or otherwise, is less than one hundred dollars; or
- (d) the question of forfeiture of the wages and effects of the seaman has been dealt with in proceedings lawfully instituted before the termination of the voyage or within forty-eight hours of the arrival of the ship at the port at which the voyage terminates.

Effects of  
seaman.

**181.** (1) The effects of a seaman described in section 187 may be sold by the Registrar of Seamen or proper officer in such manner as he thinks fit when they are delivered to him unless the Minister directs to the contrary.

(2) Where the effects are not sold pursuant to subsection (1), they may be sold by the Minister as and when he thinks fit unless they are delivered to the seaman.

(3) For the purposes of section 176 “effects” includes the proceeds of any sale of the effects of a seaman.

Return from  
service.

**182.** (1) Where during the currency of his agreement the service of a seaman belonging to a Trinidad and Tobago ship terminates otherwise than by the consent of the seaman, the master of the ship shall, in addition to—

- (a) giving the seaman a certificate of discharge required by this Act; and

(b) paying to the seaman the wages to which he is entitled, make adequate provision in accordance with this Act for maintenance and return of the seaman to a proper return port; and the master shall record the details of these provisions in the official log book.

(2) Where a master fails without reasonable cause to comply with subsection (1), the expenses of maintenance and of the journey to the proper return port—

- (a) if defrayed by the seaman, are recoverable as wages due to him; and
- (b) if defrayed by the Registrar or proper officer or any other person, are a charge upon the ship to which the seaman belonged.

(3) A charge upon a ship under subsection (2)(b) may also be recovered—

- (a) from the person who is the owner of the ship for the time being;
- (b) if the ship has been lost, from the person who was the owner of the ship at the time of the loss;
- (c) if the ship has been transferred to some person, from the owner for the time being; or
- (d) from the person who was the owner of the ship at the time of the transfer,

at the suit of the Registrar of Seamen or proper officer or other persons defraying the expenses, or, if the expenses have been defrayed out of public moneys, as a debt to the State, by ordinary process of law and in the manner in which wages are recoverable by a seaman.

**183.** (1) Where a Trinidad and Tobago ship is transferred or disposed of, any seaman belonging to that ship shall be discharged unless he consents in writing to complete the voyage of the ship if it is continued.

Discharge on ownership change.

(2) Where a seaman is discharged under this section the provisions of this Part relating to the certificate of discharge and

the return of the seaman to a proper return port apply as if his service had terminated otherwise than by his consent to be discharged during the currency of the agreement.

Certificate when  
seaman left.

**184.** (1) The master of a Trinidad and Tobago ship shall not leave a seaman behind at any foreign port or place except when the seaman is discharged in accordance with this Act, unless the master has had the certificate of the Registrar of Seamen or proper officer endorsed on the crew agreement certifying the cause of the seaman being left behind; and, the cause is unfitness or inability to proceed to sea, desertion, disappearance or otherwise.

(2) The Registrar of Seamen or proper officer to whom an application is made for a certificate under this section may examine the grounds on which a seaman is to be left behind and, for that purpose, may, if he thinks fit, administer oaths and grant or refuse the certificate as he thinks just, but a certificate may not be unreasonably withheld.

Offence.

**185.** (1) Where the master of the ship fails to comply with section 182, 183 or 184 he is, without limiting his liability under any other provision of this Act, guilty of an offence and is liable to a fine of five thousand dollars.

(2) In a prosecution for an offence under section 184, the onus of proving that the certificate was obtained or could not be obtained without reasonable delay to the ship or was unreasonably withheld is upon the master of the ship.

Account of  
wages.

**186.** (1) Where the master of a Trinidad and Tobago ship leaves a seaman behind at any foreign port or place on the ground of his unfitness or inability to proceed to sea, the master shall deliver to the person signing the certificate required by section 184 a full and true account of the wages due to the seaman; and, if that person is the proper officer, the master shall deliver the account in duplicate.

(2) A master who fails without reasonable cause to deliver the account required under subsection (1) is guilty of an offence and is liable to a fine of five thousand dollars.

**187.** (1) The master shall pay to the proper officer the wages due to a seaman left behind on the ground of his unfitness or inability to proceed to sea, if such officer will receive the wages. Payment of wages.

(2) Where a payment is made under this section, the proper officer, if satisfied with the account, shall furnish a receipt for the payment.

(3) A payment under this section shall be made, whenever practicable, in cash, and where not so practicable, by bank draft.

(4) A master who fails without reasonable cause to pay wages as provided by this section, is guilty of an offence and is liable to a fine of one thousand dollars.

**188.** Where the wages due to a seaman left behind on the ground of his unfitness or inability to proceed to sea are paid to and accepted by the Registrar of Seamen or proper officer, that officer shall deal with them in the following manner: Application of wages.

- (a) where the seaman subsequently obtains employment at or leaves the port at which the payment has been made, the officer shall obtain out of the money any expenses such as the owner or master is by this Act required to defray, and pay the remainder to the seaman and deliver to him an account of the money received and expended on his behalf;
- (b) where the seaman dies before his ship leaves the port, the officer will deal with the money as part of the property of a deceased seaman; and
- (c) where the seaman is sent to a proper return port at the public expense under this Act, the officer shall account for the money to the Minister, and after retaining any expenses duly incurred in respect of the seaman except such expenses as the owner, master or agent of the ship is required by this Act to defray, the money shall be dealt with as wages of the seaman.

Relief of  
distressed  
seaman.

**189.** (1) Where a seaman—

- (a) is found in any place outside Trinidad and Tobago after having been shipwrecked from a Trinidad and Tobago ship; or
- (b) by reason of having been discharged or left behind from a Trinidad and Tobago ship in any place outside Trinidad and Tobago is in distress in that place,

the Registrar of Seamen or proper officer may provide relief to that seaman in accordance with this Act.

(2) Relief is provided the seaman when provision is made—

- (a) for the return of the seaman at the expense of the Government of Trinidad and Tobago to a proper return port and also for his necessary clothing and maintenance until his departure for such a port;
- (b) in case of death, for burial expenses; and
- (c) in addition in the case of a shipwrecked seaman, for the repayment of any expenses incurred in his conveyance to port after his shipwreck and his maintenance while being so conveyed.

(3) A seaman for whom relief is provided under subsection (1)(a) is included within the expression “distressed seaman” in this Act.

Repayment of  
relief and return.

**190.** (1) Where any expenses are incurred by a consular officer on behalf of the Government of Trinidad and Tobago under section 189, or are incurred by the government of a foreign State and are repaid to such foreign State by the Government of Trinidad and Tobago, the Minister may pay to the consular officer or foreign government the amount of the expenses out of any moneys available for the purpose or out of any money appropriated for that purpose by Parliament.

(2) All money paid by the Minister under subsection (1), together with the wages, if any, due to a distressed seaman, is a

charge upon the ship to which the seaman belonged, and is a debt due to the Government of Trinidad and Tobago—

- (a) from the owner, master or agent of the ship at the time of the loss;
- (b) where the ship has been transferred, either from the owner for the time being or from the person who was the owner of the ship at the time of the transfer; and
- (c) where the ship is a foreign ship, also from the person, who engaged the seaman for service in the ship.

(3) A debt under this section, in addition to any fines and consular fees incurred, may be recovered by the Minister on behalf of the Government of Trinidad and Tobago by ordinary process of law in the manner in which wages are recoverable by the seaman.

(4) In any proceedings for recovery of a debt under this section, the production of an official account of the expenses incurred in accordance with this Act, and proof of payment of the expenses by or on behalf of the Government of Trinidad and Tobago is *prima facie* proof that the expenses were incurred or repaid under this Act by or on behalf of that Government.

**191.** A person is guilty of an offence who, being the master or crew of a Trinidad and Tobago ship, wrongfully forces a seaman ashore and leaves him behind, or otherwise causes a seaman to be wrongfully left behind at any place. Forcing ashore.

**192.** For the purposes of this Part, a proper return port is either— Proper return port.

- (a) the port at which a seaman was shipped or engaged;
- (b) a port in the State to which he belonged; or
- (c) in the case of a discharged seaman, some other port agreed to by the seaman at the time of his discharge.

**193.** (1) A seaman may be sent to a proper return port by any reasonable route. Manner of return.

(2) Provision may be made for the return of a seaman either by—

- (a) providing him with suitable employment on board a ship that is proceeding to a proper return port and that is in need of men to make up its complement; or
- (b) providing the seaman with a passage in any ship or aircraft or in other public transport and by providing for his maintenance during the journey.

(3) Where the master of a ship is required under this Part to provide for the return of a discharged seaman to a proper return port, the master may, instead of providing the seaman's passage or the expenses of his journey, deposit with a proper officer such sum as the proper officer considers sufficient to defray the expenses of the return of the seaman to a proper return port.

(4) Where a seaman is repatriated as a member of a crew, he is entitled to the appropriate remuneration for work done during the voyage.

Return of  
seaman.

**194.** (1) When any question arises as to what return port a seaman is to be sent, or as to the route by which he should be sent, the question shall be decided by the Registrar of Seamen or proper officer.

(2) In deciding the question of a seaman's return port, the Registrar of Seamen or proper officer shall have regard both—

- (a) to the convenience of the seaman and to the expense involved; and
- (b) to the fact that a ship is in need of men to make up its complement and is about to proceed to a proper return port or to a port in the vicinity thereof, if such is the case.

(3) Nothing in this section relieves the owner from the obligation and expense of returning the seaman to his proper return port.

Assistance by  
Minister.

**195.** (1) The Minister may, whenever he deems it necessary, spend money on the temporary relief in such

manner as he thinks advisable, of shipwrecked, destitute or otherwise distressed seamen—

- (a) not otherwise entitled to relief under this Act or under the laws of the State to which their ship belongs;
- (b) who are citizens of Trinidad and Tobago employed on a foreign vessel and discharged or left behind in a foreign State.

(2) Any expenses incurred for shipwrecked, destitute or otherwise distressed seamen under this section, shall be repaid to the Minister by the owner, master or agent of the vessel to which the distressed seamen belonged and may be recovered by the Minister on behalf of the State in the same manner as expenses incurred outside Trinidad and Tobago for distressed seamen of Trinidad and Tobago ships are recoverable.

#### PART IX

#### OFFICIAL LOG BOOK AND ORDINARY SHIP'S LOG

**196.** (1) An official log book in prescribed form shall be kept in every Trinidad and Tobago ship of not less than two hundred gross tons, and every Trinidad and Tobago ship trading from and beyond the waters of Trinidad and Tobago.

Official log book.

- (2) The Minister may make Regulations prescribing—
- (a) the form of official log books;
  - (b) the particulars to be entered in official log books;
  - (c) the persons by whom such entries are to be made, signed or witnessed; and
  - (d) the procedure to be followed in the making of such entries and in their amendment or cancellation.

(3) The official log book may, at the discretion of the master, be kept distinct from or combined with the ordinary ship's log, but in all cases the spaces in the official log book shall be duly filled with entries.

- (4) Any entry required to be made in an official log book—
- (a) shall be made as soon as possible after the occurrence to which it relates;

- (b) if it is not made on the same day as the occurrence it shall be made and dated to show the dates of the occurrence and the entry respecting it;
- (c) if it is made in respect of an occurrence happening before the arrival of the ship at her final port of discharge, it shall not be made more than twenty-four hours after that arrival.

(5) Every entry in the official log book shall be signed by the master and by an officer or some other member of the crew, and if it is an entry of illness, injury or death, it shall also be signed by the medical practitioner on board, if any.

(6) Every entry made in an official log book in the manner provided by this Act is admissible in evidence to prove the facts stated therein.

Entries in  
official log  
book.

**197.** The master of a ship for which an official log book is kept shall, subject to any Regulations made under section 196, enter or cause to be entered in the official log book particulars of—

- (a) every conviction by a Court of a member of his crew and the punishment imposed;
- (b) every offence committed by a member of his crew for which it is intended to prosecute or to make a forfeiture or to impose a fine, together with the statement concerning the furnishing of a copy, or reading over, of the entry and concerning the reply, if any, made to the charge, as required by this Act;
- (c) every offence for which punishment is imposed on board, and the punishment imposed;
- (d) the conduct, character and qualifications of each member of his crew or a statement that he declines to give an opinion on these particulars;
- (e) every case of illness or injury happening to a member of the crew, with the nature thereof and the medical treatment given, if any;
- (f) every refusal of a member of the crew to take antiscorbutics or medicines;

- (g) every birth and death happening on board his ship;
- (h) every marriage taking place on board, with the names and ages of the parties;
- (i) the name of every seaman who ceases to be a member of the crew otherwise than by death, with the place, time, manner and cause thereof;
- (j) the wages due to any seaman who dies during the voyage, and the gross amount of all deductions to be made from those wages;
- (k) the sale of the effects of any seaman who dies during the voyage, with a statement of each article sold and the sum received for it;
- (l) every collision with any other ship and the circumstances in which it occurred;
- (m) the date and the time of the display in the ship of a notice containing particulars of the ship's draught and freeboard; and
- (n) any matter directed by this Act to be entered.

**198.** (1) The master or the owner of every Trinidad and Tobago ship for which an official log book is required to be kept, shall, within twenty-one days after the 30th June and the 31st December in each year or upon completion deliver the official log book for the preceding half-year to the Director.

Copy of official log book.

(2) The owner shall retain the copy of the official log book for a period of seven years after delivery and shall produce it on demand made therefor by the Registrar or other proper officer.

(3) A master or owner of a ship who fails without reasonable cause to comply with this section is guilty of an offence.

**199.** (1) Where, by reason of transfer of ownership or change of employment of a ship, the official log book ceases to be required in respect of the ship, the master or owner of the ship shall, if the ship is then in a port of Trinidad and Tobago within one month, or if she is elsewhere, within six months after such cessation, deliver or transmit to the Director the official log book and the agreement with the crew duly made out to the time of the cessation.

Delivery of official log book to Director in case of transfer of ownership of a ship.

(2) If a ship is lost or abandoned, the master or owner thereof shall, if practicable, and as soon as possible, deliver or transmit to the Director the official log book duly made out to the time of the loss or abandonment.

(3) The owner or master of a ship who fails, without reasonable cause, to comply with this section is guilty of an offence.

Offences in respect of log book.

**200.** (1) If an official log book is not kept in the manner required by this Act or if any entry directed by this Act to be made therein is not made at the time and in the manner directed by this Act, the master of the ship is guilty of an offence and, except as otherwise expressly provided in this Act in respect thereof, is liable to a fine of five hundred dollars.

(2) Any person who makes, procures to be made, or assists in making an entry in an official log book in respect of any occurrence happening previous to the arrival of the ship at its final port of discharge of the crew, more than twenty-four hours after that arrival, is guilty of an offence and is liable to a fine of five hundred dollars.

(3) Any person who wilfully destroys, mutilates or renders illegible an entry in an official log book, or wilfully makes, procures to be made or assists in making a false or fraudulent entry in, or omission from, an official log book is guilty of an offence.

Ordinary ship's log.

**201.** (1) All Trinidad and Tobago ships shall carry on board an ordinary ship's log wherein shall be recorded the daily activities of the ship and such other particulars as may be prescribed.

(2) Where a ship is not required by this Act to carry an official log book, or where it is not practicable for a ship to produce the official log book, the ordinary log book of the ship shall be admissible in evidence.

Returns of crew of ship.

**202.** (1) Every master of a Trinidad and Tobago ship of not less than two hundred gross register tons shall make out and sign a list of the crew of the ship in the prescribed form containing the following particulars:

- (a) the number and date of the ship's register and its net register tonnage;

- (b) the length and general nature of the voyage or employment;
  - (c) the names, ages and places of birth of all the crew, their ratings on board, their last ships or other employments and the dates and places of their last ships or other employments and the dates and places of their joining the ship;
  - (d) the names of any of the crew who have ceased to belong to the ship, with the times, places, causes and circumstances thereof;
  - (e) the names of any members of the crew who have been maimed or hurt, with the time, place, cause and circumstances thereof;
  - (f) the wages due at the time of death to any of the crew who have died;
  - (g) particulars of the property belonging to any of the crew who have died, with a statement of the manner in which the property has been dealt with, and the money for which any part of it has been sold; and
  - (h) details of any marriage that has taken place on board, with the date thereof and the names and ages of the parties.
- (2) The list of the crew—
- (a) in the case of ships trading exclusively within the waters of Trinidad and Tobago or between Caricom ports shall be delivered or transmitted by the master or owner to the Director not later than twenty-one days after the 30th day of June and the 31st day of December in each year; and
  - (b) in the case of ships other than those referred to in paragraph (a) shall be delivered or transmitted by the master to the owner of the ship who shall retain the list for a period of seven years after receipt and who shall produce the same on demand made therefor by the Director or other proper officer—
    - (i) within forty-eight hours after the arrival of the ship at its final port of destination in Trinidad and Tobago; or

- (ii) upon the discharge of the crew, whichever first happens.

(3) Where a Trinidad and Tobago ship is lost or abandoned, the ship's master or owner shall, if practicable and as soon as possible, deliver to the Director the list of the crew duly made out to the time of the loss or abandonment.

(4) For the avoidance of doubt, "crew" in this section includes the master and apprentices.

Returns of  
births and  
deaths.

**203.** (1) The master of a Trinidad and Tobago ship upon its arrival at a port or at such other time and place as the Director may with respect to any ship or class of ships direct, shall deliver, in the prescribed form, a return of the facts recorded by the master in respect of a birth or death on board the ship—

- (a) to the Director if the ship is in Trinidad and Tobago; or  
(b) to a proper officer if the ship is elsewhere.

(2) When the return is made elsewhere than Trinidad and Tobago the proper officer shall send a certified copy of the return to the Director.

(3) The Director shall cause the information contained in the return or copy thereof to be sent to the authority having responsibility for the registration of births and deaths.

(4) The master of any ship who fails to comply with any requirement of this section is guilty of an offence and is liable to a fine of one thousand dollars.

#### PART X

#### SAFETY PRECAUTIONS AND NAVIGATIONAL SAFETY

Collision  
Regulations.

**204.** (1) The Minister may make Regulations, hereinafter referred to as "Collision Regulations"—

- (a) for the prevention of collisions at sea;  
(b) respecting the lights to be carried and exhibited;  
(c) respecting the other signals to be carried and used; and

UNOFFICIAL VERSION

UPDATED TO 31ST DECEMBER 2016

(d) respecting the steering and sailing rules to be observed by ships,

and in making such Regulations he shall have regard to any international convention or treaty for the time being in force for the prevention of collisions at sea.

(2) All owners and masters of ships, and of seaplanes and other craft shall comply with the Collision Regulations and shall not carry or exhibit any lights or use any signals other than those required by the Collision Regulations.

(3) A master or owner who contravenes the Collision Regulations by wilful default is guilty of an offence and is liable to a fine of five thousand dollars and imprisonment for six months.

**205.** If any damage to property arises from failure to comply with the Collision Regulations, the damage is presumed to have been caused by the wilful default of the person in charge of the ship, seaplane or other craft at the time, unless it is shown to the satisfaction of the Court that the circumstances of the case made a departure from the Collision Regulations necessary.

Presumption of fault.

**206.** A surveyor of ships or any other marine officer may inspect a ship of any nationality in a port of Trinidad and Tobago to determine whether the ship is properly provided with lights and shapes and the means of making sound signals as required by the Collision Regulations; and if the surveyor or other marine officer finds that the ship is not so provided, he shall specify the action required to rectify the deficiency and shall detain the ship until such deficiency is rectified to his satisfaction.

Inspection of ships to enforce compliance with Collision Regulations.

**207.** (1) In every case of collision between two ships, the master or person in charge of each ship, if and so far as he can do so without danger to his own ship, crew and passengers, shall—

Duty of ship to assist in case of collision.

(a) render to the other ship, its master, crew and passengers, such assistance as may be practicable and necessary to save them from any danger caused by the collision, and shall stay by the other ship until he has ascertained that there is no further need for assistance; and

(b) give to the master or person in charge of the other ship the name of his own ship and the Port of Registry to which it belongs, and also the name of its previous port of call and the port to which it is bound.

(2) The master or person in charge of a ship who fails, without reasonable cause, to comply with this section, is guilty of an offence and, in addition, if he is an officer certificated or licensed under this Act, he shall be subject to an inquiry into his conduct as provided in section 375.

(3) The failure of the master or person in charge of a ship to comply with the provisions of this section shall not raise any presumption of law that the collision was caused by his wrongful act, neglect or default.

Record of boat drill or fire drill to be kept in official log book.

**208.** (1) The master of every Trinidad and Tobago ship shall cause a statement to be entered in the official log book or ordinary ship's log, or if there is none, cause other record to be kept, of every occasion on which boat drill is practised on board the ship, or on which the appliances and equipment required by the rules for life-saving appliances to be carried are examined to see whether they are fit and ready for use, and of the result of any such examination, and where—

- (a) in the case of a passenger ship, boat drill or fire drill is not practised on board the ship in any week;
- (b) in the case of any other ship, boat drill or fire drill is not practised on board the ship in any two weeks;
- (c) in the case of any ship, the said appliances and equipment are not examined in any such period as is prescribed,

the master shall cause a statement to be entered or other record to be kept as aforesaid, of the reasons why the drill was not practised or the appliances and equipment were not examined in that week or two-week period.

(2) The master of a ship who fails to comply with the requirements of this section is guilty of an offence.

**209.** Every Trinidad and Tobago ship shall be manned with a crew sufficient and efficient from the point of view of safety of life for the purpose of the intended voyage, and shall during such voyage be kept so manned.

Crew sufficient and efficient.

**210.** (1) The master of any Trinidad and Tobago ship upon encountering dangerous ice, a dangerous derelict, a tropical storm or any other direct danger to navigation shall send information accordingly by any means of communication at his disposal and in accordance with the Regulations to all ships in the vicinity or to such authorities ashore as may be prescribed.

Obligation to notify hazards of navigation.

(2) Every person in charge of a radio station in Trinidad and Tobago or on board any Trinidad and Tobago ship, shall, on receiving the signal prescribed in the Regulations for indicating that a message is about to be sent under this section, refrain from sending messages for a time sufficient to allow other stations to receive the message, and if so required by Regulations made under subsection (1) shall transmit the message in the prescribed manner.

(3) For the purpose of this section, a “tropical storm” means a hurricane, typhoon, cyclone or other storm of a similar nature, and a master of a ship shall be deemed to have encountered a tropical storm if he has reason to believe that there is such a storm in the vicinity.

(4) A transmission of messages in pursuance of this section shall be without charge.

**211.** (1) The Director shall take appropriate steps to advise the seafaring community and the public of any developing or existing situation which may adversely affect maritime safety.

Notices to Mariners and Navigational Warnings.

(2) Such information shall take the form of Notices to Mariners and Navigational Warnings which may be issued and communicated by any means as the circumstances may warrant.

(3) The Director may require the assistance of any person in the communication of such information and a person who without reasonable cause refuses to render such assistance when so requested is guilty of an offence and is liable to a fine of one thousand dollars.

Master to proceed moderately in danger area.

**212.** (1) The master of a Trinidad and Tobago ship, when ice is reported on or near his course, shall at night either proceed at a safe speed adapted to the prevailing circumstances or change his course so as to keep amply clear of the ice reported and of the area of danger.

(2) The master of a ship who fails to comply with this section, is guilty of an offence and is liable to a fine of one thousand dollars.

Obligation to assist vessels in distress.

**213.** (1) The master of a Trinidad and Tobago ship at sea on receiving a signal from any source that a ship or aircraft or survival craft thereof is in distress shall proceed at maximum speed to the assistance of the persons in distress, informing them if possible, that he is doing so, but if he is unable, or in the special circumstances of the case considers it unreasonable or unnecessary, to proceed to their assistance, he shall enter in the official log book the reason for failing to proceed to the assistance of the persons in distress.

(2) The master of any ship in distress may, after consultation so far as possible with the masters of the ships which answer his distress signal, requisition such one or more of the ships as he considers best able to render assistance and it shall be the duty of the master of a Trinidad and Tobago ship that is so requisitioned to comply with the requisition by continuing to proceed at maximum speed to the assistance of the persons in distress.

(3) The master or person in charge of a ship who fails, without reasonable cause, to comply with this section, is guilty of an offence and, in addition, if he is an officer certificated or licensed under this Act, he shall be subject to an inquiry into his conduct as provided in section 375.

(4) Compliance with the provisions of this section shall not affect the right of salvage.

Signals of distress.

**214.** (1) The Minister may make Regulations relating to signals of distress and urgency and the signals prescribed by the Regulations shall be deemed to be signals of distress and urgency.

(2) Where a master of a ship uses or displays or causes or permits any person under his authority to use or display—

- (a) any signal except in circumstances and for the purposes prescribed; and
- (b) any signal that is liable to be mistaken for any prescribed signal,

he is guilty of an offence and, in addition to any penalty imposed upon him on conviction, he is liable to pay compensation for any labour undertaken, risk incurred or loss sustained in consequence of the signal having been supposed to be a signal of distress or urgency; and such compensation may, without prejudice to any other remedy, be recovered in the same manner in which salvage is recoverable.

(3) Where the master who contravenes subsection (2) is an officer certificated or licensed under this Act, he shall be subject to an enquiry into his conduct as provided in section 375.

**215.** (1) Where any ship to which this section applies has been involved in any accident or incident whether or not occasioning loss of life or any serious injury to any person, or has received any material damage affecting its seaworthiness or its efficiency either in its hull or, in the case of a ship propelled by mechanical power, in any part of its machinery, or has been in collision with another ship the master shall as soon as practicable after the happening of the accident or damage, transmit to the Director, a report of the accident or damage, and of the probable cause thereof, stating the name of the ship, its official number, its Port of Registry or the port to which it belongs and its location.

Report of  
accident and  
loss of ship.

(2) If the managing owner, or in the event of there being no managing owner or no such owner resident in Trinidad and Tobago, the agent of any ship to which this section applies has reason to believe that the ship has sustained or caused any such accident or received any such damage as is mentioned in subsection (1), he shall satisfy himself that the accident or damage has been reported to the Director by the master; and, where any such managing owner or agent has reason to believe that the

accident or damage has not been so reported, he shall as soon as possible, send to the Director notice in writing stating the name of the ship, its official number, and its Port of Registry or the port to which it belongs, and stating to the best of his knowledge and belief, the nature and extent of the accident or damage, the probable cause thereof and the location of the ship.

(3) This section applies to any ship to which any such accident or damage, as is mentioned in the foregoing provisions of this section, occurs or is believed to have occurred, in the waters of Trinidad and Tobago.

(4) The master or managing owner or agent who fails, without reasonable cause to comply with this section is guilty of an offence and is liable to a fine of one thousand dollars.

Apprehended  
loss of ship.

**216.** (1) Where the managing owner or, in the event of there being no managing owner, or no such owner resident in Trinidad and Tobago, the agent of any ship to which this section applies has reason, owing to the non-appearance of the ship or to any other circumstance, to believe that the ship has been totally lost, he shall, as soon as possible, send to the Director notice in writing stating the name of the ship, its official number, its Port of Registry or the port to which it belongs and stating also to the best of his knowledge and belief, the probable cause of the loss.

(2) This section applies to—

- (a) Trinidad and Tobago ships; and
- (b) other ships which are lost or are believed to have been lost in the waters of Trinidad and Tobago.

(3) A managing owner or agent who fails without reasonable cause to comply with this section within a reasonable time is guilty of an offence and is liable to a fine of one thousand dollars.

#### NAVIGATIONAL AIDS

Interpretation.

**217.** In this Part “navigational aids” and “aids” means all lighthouses, buoys, beacons, radio aids, or any other light, signal or mark established to aid marine navigation and includes all buildings, moorings, and other works associated therewith.

**218.** (1) There shall be established in Trinidad and Tobago such navigational aids as are necessary to facilitate the safe navigation of ships within the waters of Trinidad and Tobago.

Establishment and management.

(2) Privately owned navigational aids shall be established and maintained in accordance with the provisions of this Act.

**219.** (1) No navigational aid shall be established—

(a) without the prior written consent of the Minister, or any other person authorised by him for the purpose; and

(b) unless it conforms to such specifications as may be stipulated.

Minister's permission to establish navigational aids.

(2) No navigational aid shall be discontinued or have its lighting characteristics or any other distinguishing feature altered, without the prior written consent of the Minister or any other person authorised by him for the purpose.

(3) The Minister shall by Notice cause a list of navigational aids to be published and updated as necessary.

**220.** The Director shall exercise general supervision over all navigational aids and in particular shall—

Functions of the Director.

(a) be responsible for the establishment and maintenance of all navigational aids established by the Maritime Services Division and such other government owned navigational aids as may be under the control of that Division;

(b) ensure that all other navigational aids are established in compliance with the stipulated conditions and specifications and are maintained in proper working order; and

(c) bring to the attention of the public information on changes to or deficiencies in any navigational aid.

**221.** A person who—

Offence.

(a) contravenes section 219;

(b) wilfully or negligently damages, destroys or allows a ship to foul an aid;

- (c) wilfully or negligently does anything which causes the view of an aid to be obstructed in such a manner as to lessen its efficiency;
- (d) wilfully, negligently or without lawful authority does anything which interferes with an aid so as to hinder the effective use of the aid;
- (e) trespasses on or without lawful excuse, is found in or on—
  - (i) an aid; or
  - (ii) any land upon which an aid is situated; and
- (f) fails to notify the Director as soon as practicable after the aid is damaged, destroyed or fouled,

is guilty of an offence and, in addition to the expenses of making good any damage so occasioned, is liable to a fine of five thousand dollars.

Detention.

**222.** Where a ship damages, destroys or fouls an aid, the ship may be detained until the cost of repairing or replacing the aid or rendering the aid effective again is paid.

Power of the Director on failure to extinguish false or unauthorised lights, etc.

**223.** For the purpose of extinguishing false or unauthorised lights, the Director may enter the place where the fire or light is and forthwith extinguish the same without causing unnecessary damage, and recover the expense thereby incurred.

Penalty for failure to pay navigational aid dues.

**224.** Where, without reasonable cause, the owner or master of a ship fails to pay the navigational aid dues, the owner and the master are each guilty of an offence and are each liable to a fine equivalent to four times the dues and in addition the ship may be detained.

Regulations.

- 225.** (1) The Minister may make Regulations—
- (a) stipulating the system of lighting and other characteristics, marks and features of navigational aids;
  - (b) for the levying, collecting and disposition of dues in respect of navigational aids;

- (c) prescribing the penalties for any contravention of such Regulations; and
- (d) for the exemption of particular ships or classes of ships from the requirements relating to the payment of dues for navigational aids.

(2) In making Regulations with respect to subsection (1)(a), the Minister shall have due regard to the IALA (International Association of Lighthouse Authorities) Harmonised Buoyage “System B”, or any other international system of buoyage which may replace it.

#### PART XI

#### APPLICATION OF THE CONVENTION FOR THE SAFETY OF LIFE AT SEA

**226.** In this Part—

Interpretation.

“certificate” means a certificate issued in accordance with the Safety Convention as defined therein;

“fishing vessel” means a vessel used for catching fish, whales, seals, walrus or other living resources of the sea;

“short international voyage” means an international voyage—

- (a) in the course of which a ship is not more than 200 nautical miles from a port or place in which the passengers and crew could be placed in safety; and
- (b) which does not exceed 600 nautical miles in length between the last port of call in the country where the voyage begins and the final destination,

no account being taken of any deviation by a ship from its intended voyage due solely to stress of weather or any other circumstances that neither the master nor the owner nor the charterer, if any, of the ship could reasonably have prevented or forestalled;

“Safety Convention” means the International Convention for the Safety of Life at Sea, 1974 and its Protocol of 1978, together with such amendments thereof or replacements therefor as the Minister may, by Order declare to be in effect in respect of Trinidad and Tobago;

“Safety Convention Certificate” means a certificate that is required to be issued to a Safety Convention ship that complies with the relevant provisions of the Safety Convention and includes a safety certificate, safety construction certificate, safety equipment certificate, safety radio-telephony certificate, safety radio telegraph certificate and any such certificate that is limited, modified or restricted by an exemption certificate;

“Safety Convention ship” means a ship to which the Safety Convention applies;

“Safety Convention State” means a State the government of which has accepted the Safety Convention and which has not denounced that Convention;

“surveyor” includes any person or organisation, duly authorised by the Minister to act as surveyor for the purpose of surveying ships and issuing Safety Convention Certificates.

States to which  
Safety  
Convention  
applies.

**227.** The Minister may by Notice publish a list of States that have ratified, acceded to or denounced the Safety Convention.

Application of  
Safety  
Convention  
Regulations.

**228.** The Regulations annexed to the Safety Convention or any Regulations annexed to any other Convention which may be substituted for the Safety Convention and which have been accepted on behalf of Trinidad and Tobago shall, unless exempted by or under this Act, apply to Trinidad and Tobago ships and other ships while they are within the waters of Trinidad and Tobago.

Regulations to  
enforce the  
Safety  
Convention.

**229.** The Minister may, in relation to any ship to which the Safety Convention applies, make Regulations in order to give full effect to the Safety Convention and such Regulations may include matters for which there are no express provisions in the Convention.

Breach of  
Safety  
Regulations.

**230.** In the case of any ship, where—

- (a) the ship is required by the Safety Convention or by the Regulations relating thereto to be provided with appliances and it proceeds to sea without being so provided;
- (b) any of the appliances with which the ship is so provided is lost or rendered unfit for service while at sea through the wilful fault or negligence of the owner or master;

- (c) the owner or master wilfully neglects to replace or repair, any such appliance, lost or rendered unfit at the first opportunity;
- (d) such appliances are not kept serviceable and ready for use at all times; or
- (e) any provision of the Regulations save such provisions as relate to the carriage of dangerous goods, is contravened or not complied with,

the owner and the master of the ship are guilty of an offence and are each liable to a fine of one thousand dollars.

**231.** (1) The Minister may, from time to time, appoint at such places as he deems advisable, persons as surveyors of ships competent to inspect—

Appointment of surveyors.

- (a) the boilers and machinery of ships;
- (b) the equipment of ships, including ships' tackle, and apparel and appurtenances;
- (c) the hulls and superstructures of ships;
- (d) the life-saving, fire-fighting and other safety equipment of ships;
- (e) the radio-telegraphy and radio-telephony installations of ships;
- (f) the stowage and manner of loading of ships' cargoes and the stowage of dangerous goods in ships.

(2) A surveyor of ships may be appointed in several capacities to perform different functions.

(3) The survey and inspection of ships, so far as regards the enforcement of the Regulations made under this Part, shall be carried out by the surveyors or, subject to such conditions as the Minister may impose, by any corporation or society for the survey and classification of ships authorised by the Minister.

**232.** (1) A surveyor of ships may at all reasonable times inspect any ship for the purpose of ensuring that it is in compliance with the Safety Convention, the Load Line Convention, the Collision Regulations and the relevant Regulations made under this Act.

Surveyor's powers of inspection.

(2) Where the surveyor finds that the said Conventions or the Regulations have not been complied with, he shall give written notice to the owner or master of the ship stating in what respect there is deficiency and what action in his opinion, is required to rectify such deficiency.

(3) Every notice so given shall be communicated in a manner directed by the Minister to the Customs and Excise Officer of any port at which the ship may seek a clearance and such clearance shall not be granted and the ship shall be detained.

(4) Where the surveyor considers such ship unsafe, or, where a passenger ship, unfit to carry passengers, or the machinery or equipment defective in any way so as to expose persons on board to serious danger, he shall detain that ship, and a surveyor may also detain any ship in respect of which any of the provisions of this Act have not been complied with, if in his opinion such detention is warranted in the circumstances.

(5) Where, under this section, a surveyor visits any ship he may ask the owner or his agent, the master or chief engineer, or any other person on board and in charge or appearing to be in charge, of the ship, any questions concerning the ship as he thinks fit and every such person shall fully and truthfully answer every such question.

(6) A surveyor may reasonably require of the owner or his agent, the master or chief engineer, or any other person on board or in charge, or appearing to be in charge of the ship that the machinery of the ship be activated or dismantled so that he may satisfy himself as to its condition and every person of whom such a request was made capable of so doing, shall comply with such requirement.

(7) A person who contravenes subsection (5) or (6) is guilty of an offence and is liable to a fine of one thousand dollars.

Surveyor's  
report for  
Director.

**233.** A surveyor, where satisfied on inspection that he can with propriety do so, shall forward a report to the Director which shall contain a statement showing—

(a) that the hull and machinery are sufficient for the service;

- (b) that the hull and machinery are constructed, arranged and fitted in accordance with any Regulations made under this Part;
- (c) that the equipment required under any Regulations is on board and in good condition;
- (d) that the master, mates and engineers are persons duly certificated as required under this Act and that the crew is sufficient and efficient;
- (e) the class of voyage for which the ship is fit to ply and the time, if less than one year, for which the hull, equipment and machinery will be sufficient;
- (f) if the ship is a passenger ship the number of passengers which it may carry; and
- (g) the steam pressure that may be carried on the boilers.

**234.** A surveyor shall keep a record of the inspections he makes and certificates he issues in such form and with such particulars respecting them as the Director may direct, and shall furnish copies thereof and any other information pertaining to the duties of his office which the Director may require.

Record of inspections and certificates.

**235.** Every Trinidad and Tobago passenger ship shall be subjected to the surveys specified below, namely—

Survey of passenger ships.

- (a) a survey before the ship is put into service;
- (b) a periodic survey at intervals of not more than twelve months;
- (c) additional surveys as required under the Act.

**236.** (1) The survey made before a passenger ship is put into service, shall include a complete inspection of the hull, machinery and equipment.

Initial survey.

(2) The survey shall be such as to ensure that the general arrangement, material and scantlings of the hull, boilers and other pressure vessels, the main and auxiliary machinery, electrical installations, radio installations, radio installations in motor-life boats, portable radio apparatus for survival craft, life-saving appliances,

fire-detecting and extinguishing appliances, pilot ladders, and other equipment fully comply with the requirements of the Safety Convention and with any Regulations made under section 229.

(3) The survey shall also be such as to ensure that the workmanship of all parts of the hull and machinery and equipment is satisfactory, and that the ship is provided with such lights and sound signals and distress signals as are required by the Safety Convention and the Collision Regulations.

Periodic surveys.

**237.** (1) The periodic survey shall be such as to ensure that the hull, boiler and other pressure vessels, the main and auxiliary machinery, electrical installations, radio installations, radio installation in motor-life boats, portable radio apparatus for survival craft, life-saving appliances, fire-detecting and extinguishing appliances, pilot ladders, and other equipment are in a satisfactory condition and fit for the service for which they are intended and that they comply with the requirements of the Safety Convention and any Regulations made under section 229.

(2) The lights and sound signals and the distress signals carried by the ship shall also be subject to the survey.

Additional surveys.

**238.** (1) A survey, either general or partial, as the circumstances require, shall be made every time an accident occurs or a defect is discovered which affects the safety of the ship or the efficiency or completeness of its life-saving appliances or other equipment or whenever important repairs or replacements are made.

(2) The survey shall be such as to ensure that the necessary repairs or renewals have been effectively made, that the material and workmanship of such repairs or replacements are in all respects satisfactory and that the ship complies in all respects with the provisions of the Safety Convention and of the Collision Regulations and any Regulations made under this Act.

Issue of Safety Certificate to passenger ships.

**239.** (1) Where the Minister or such other person as he may authorise for the purpose, on receipt of the surveyor's report referred to in section 233, is satisfied that a Trinidad and Tobago ship is in compliance with—

- (a) the requirements of the Safety Convention as regards construction, life-saving appliances, radio and direction finders; and

- (b) such of the rules relating to safety of life at sea as are applicable to the ship and to such international voyages as it is to be engaged on, and that it is properly provided with the lights, shapes and means of making signals required by the Collision Regulations,

he shall on the application of the owner, issue the appropriate Safety Certificate, hereinafter referred to as “a Passenger Ship Safety Certificate” and an Inspection Certificate, in respect of that ship.

(2) A Passenger Ship Safety Certificate may together with any other Safety Certificate required under this Act be contained in one document.

**240.** Where the voyages on which a ship is to be engaged are short international voyages and it complies only with such of the Regulations as are applicable to those voyages, the Director shall issue a certificate, (hereinafter referred to as “a Short Voyage Certificate”), showing that the ship complies with the requirements of the Safety Convention applicable to such short international voyages.

Short Voyage Certificate.

**241.** Where the Minister or such other person as he may authorise for the purpose, on receipt of the surveyor’s report in respect of any passenger ship as aforesaid is satisfied—

Exemption Certificate and Qualified Certificate.

- (a) that the ship is eligible for exemption, under this Act, from any of the requirements of the Regulations or of the Safety Convention applicable to the ship and to such international voyages on which it is to be engaged;
- (b) that it complies with the remainder of those requirements and that it is properly provided with the lights, shapes and means of making sound signals required by the Collision Regulations,

he shall, on the application of the owner, issue in respect of the ship—

- (i) an Exemption Certificate stating from which of the requirements of the Safety Convention the ship is exempt, and that the

exemption is conditional on the ship plying only on the voyages and being engaged only in the trades and complying with the other conditions, if any, specified in the certificate; and

- (ii) a certificate (hereinafter referred to as “a Qualified Safety Certificate”) or a Qualified Short Voyage Certificate, as the case may be, showing that the ship complies with those requirements from which it is not exempt.

Validity of Short Voyage Certificates for passenger ships.

**242.** The Minister or such other person as he may authorise for the purpose, may permit any passenger ship in respect of which there is in force a Short Voyage Certificate, or a Qualified Short Voyage Certificate, to proceed to sea on an international voyage from a port in Trinidad and Tobago, not exceeding twelve hundred nautical miles between that port and the final port of destination, and for the purposes of this section, such Certificate shall be endorsed for the voyage on which the ship is about to proceed notwithstanding that the voyage exceeds six hundred nautical miles between those ports.

Passenger Safety Certificate to be carried on board.

**243.** (1) Every passenger ship shall, before plying or proceeding to sea from any port in Trinidad and Tobago have on board a valid Passenger Ship Safety Certificate which shall show—

- (a) the limits, if any, beyond which the ship is not fit to ply; and
- (b) the number of passengers which the ship is fit to carry, distinguishing, if necessary, the number to be carried in each part of the ship, and any conditions and variations to which the number is subject.

(2) Where in the case of a foreign passenger ship, the Minister or such other person as he may authorise for the purpose, is satisfied upon the production of a Passenger Ship Safety Certificate that the provisions of this Act have been substantially complied with, the ship shall be deemed to have satisfied the requirements of subsection (1).

**244.** Where a passenger ship has on board a number of passengers which, having regard to the time, occasion and circumstances of the case, is greater than the number allowed by the Passenger Ship Safety Certificate, the owner or master of the ship shall, without prejudice to any other remedy or penalty under this Act, be liable to a fine of two hundred dollars for every excess passenger.

Penalty for carrying excess passengers.

**245.** (1) The life-saving appliances and fire-fighting appliances of Trinidad and Tobago cargo ships shall be subject to survey before the ship is put into service and thereafter at intervals of not more than two years.

Surveys of life-saving appliances and other equipment of cargo ships.

(2) The fire control plans in Trinidad and Tobago ships and the pilot ladders, lights and sound signals and distress signals in new and existing Trinidad and Tobago cargo ships shall be included in the surveys for the purpose of ensuring that they comply fully with the requirements of the Safety Convention and, where applicable, the Collision Regulations.

**246.** Where the Minister or such person as he may authorise for the purpose is satisfied, on receipt of the surveyor's report in respect of a Trinidad and Tobago cargo ship, that the ship complies with the requirements of the Safety Convention as regards life-saving appliances and with such of the Regulations relating to safety of life at sea as are applicable to the ship in regard to such life-saving appliances and to such voyages as it is to be engaged on, and, that it is properly provided with the lights, shapes and means of making sound signals required by the Collision Regulations, he shall, on the application of the owner, issue in respect of the ship—

Issue of Safety Equipment Certificate for cargo ships.

- (a) where it is not less than five hundred gross register tons and is to be engaged on international voyages, a certificate in the form prescribed by the Safety Convention;
- (b) in any other case, a certificate showing that it complies with the said requirements,

and any such certificate is in this Act referred to as a "Safety Equipment Certificate".

Exemption  
Certificate and  
Qualified Safety  
Equipment  
Certificate.

**247.** Where the Minister or such person as he may authorise for the purpose on receipt of the surveyor's report in respect of a cargo ship, is satisfied that the ship is exempt by this Act or from any of the requirements of such Regulations or of the Safety Convention, applicable to the ship and to such voyages as it is to be engaged on, and that the ship complies with the remainder of those requirements and is properly provided with the lights, shapes and means of making sound signals required by the Collision Regulations, he shall, on the application of the owner, issue in respect of the ship—

(a) where it is not less than five hundred tons gross tonnage and is to be engaged on international voyages—

(i) an exemption certificate stating from which of the requirements of the Safety Convention the ship is exempt and that the exemption is conditional on the ship plying only on the voyages and being engaged only in the trade and complying with any other conditions, specified in the certificate; and

(ii) a certificate showing that the ship complies with those requirements from which it is not exempt;

(b) in any other case, a certificate showing that the ship complies with such of the requirements of the Safety Convention from which it is not exempt and to the voyages on which it is to be engaged,

and any certificate issued under paragraph (a)(ii) or (b) is in this Act referred to as a "Qualified Safety Equipment Certificate".

Surveys of radar  
and radio  
installations on  
cargo ships.

**248.** The radio and radar installations of Trinidad and Tobago cargo ships and any radio-telegraph installations in a motor-life boat or portable radio apparatus for survival craft which is carried in compliance with any regulations made under section 229, shall be subject to survey before the ship is put into service and thereafter at intervals of not more than twelve months.

**249.** Where the Minister or such person as he may authorise for the purpose is satisfied on receipt of the surveyor's report in respect of a Trinidad and Tobago cargo ship that the ship complies with the requirements of the Safety Convention as regards radio-telegraphy, radio-telephony, and direction finders and with such of the Regulations relating to safety of life at sea as are applicable to the ship in regard to such radio-telegraphy, radio-telephony and direction finders and to such international voyages, as it is to be engaged on, he shall, on the application of the owner, issue in respect of the ship—

Issue of Radio Certificate.

- (a) a certificate in the form prescribed by the Convention where the ship is of not less than three hundred gross tons and is to be engaged on international voyages;
- (b) a certificate showing that it complies with the said requirements,

and any such certificate is in this Act referred to as a "Radio Certificate".

**250.** Where the Minister or such person as he may authorise for the purpose, on receipt of the surveyor's report in respect of a cargo ship, is satisfied that the ship is eligible for exemption under this Act, from any of the requirements of those of the Regulations or of the Safety Convention applicable to the ship as regards radio-telegraphy, radio-telephony and direction finders and to such voyages as it is to be engaged on, and that the ship complies with the remainder of those requirements and is properly provided with the lights, shapes and means of making sound signals required by the Collision Regulations, he shall, on the application of the owner, issue in respect of the ship—

Exemption Certificate and Qualified Radio Certificate.

- (a) where it is not less than five hundred gross register tons and is to be engaged on international voyages—
  - (i) an exemption certificate stating which of the requirements of the Safety Convention the ship is exempt from and that the exemption is conditional on the ship plying only on the voyages and being engaged only in the trade and complying with the other conditions, specified in the certificate, and

- (ii) a certificate showing that the ship complies with those requirements from which it is not exempt;
- (b) in any other case, a certificate showing that the ship complies with such of the requirements of the Safety Convention from which it is not exempt and the voyages on which it is to be engaged,

and any certificate issued under paragraph (a)(ii) or paragraph (b) of this section is in this Act referred to as a “Qualified Radio Certificate”.

Radio  
Exemption  
Certificate.

**251.** Where any Trinidad and Tobago ship is wholly exempted by the Minister or such other person authorised by him for the purpose from the requirements of the Regulations relating to the Safety Convention as regards radio-telegraphy, radio-telephony and direction finders there shall be issued upon application by the owner, an exemption certificate, hereinafter referred to as a “Radio Exemption Certificate” specifying the voyages and trades for and conditions on which, the ship is so exempt.

Surveys of hull,  
machinery and  
equipment of  
cargo ships.

**252.** (1) The hull, machinery and equipment other than items in respect of which Cargo Ship Safety Equipment Certificates, Cargo Ship Safety Radio-telegraphy Certificates or Cargo Ship Radio-telephony Certificates are issued of a Trinidad and Tobago cargo ship shall be surveyed before being put into service and thereafter in such a manner and at such intervals as may be prescribed under this Part.

Cargo Ship  
Construction  
and Survey  
Regulations.

**253.** (1) The Minister may make Regulations (in this Act referred to as “Cargo Ship Construction and Survey Regulations”) prescribing requirements for the hull, equipment and machinery of ships to which this section applies and requiring any Trinidad and Tobago ship to be surveyed to such an extent, in such a manner and at such intervals as may be prescribed.

(2) The said Regulations shall include such requirements as appear to the Minister to implement the

provisions of the Safety Convention relating to the hull, equipment and machinery of such ships.

- (3) This section applies to—
- (a) Trinidad and Tobago ships of not less than five hundred gross tons;
  - (b) Trinidad and Tobago ships of such lower tonnage and of such description as the Minister may specify; and
  - (c) foreign ships while they are within the waters of Trinidad and Tobago and while they are not exempted under this Act,

but does not apply to passenger ships, troopships, pleasure crafts, fishing vessels and ships not propelled by mechanical means.

**254.** Where the Minister or such person as he may authorise for the purpose is satisfied, on receipt of the surveyor's report in respect of a Trinidad and Tobago cargo ship to which section 253 applies, that the ship complies with the Cargo Ship Construction and Survey Regulations applicable to the ship and such voyages as it is to be engaged on, he shall, on the application of the owner, issue in respect of the ship—

Issue of Cargo Ship Safety Construction Certificate.

- (a) a certificate in the form prescribed by the Convention where it is not less than five hundred gross tons and is to be engaged on international voyages, and
- (b) in any other case a certificate showing that it concurs with the said regulations,

and any such certificate is in this Act referred to as a "Cargo Ship Safety Construction Certificate".

**255.** Where the Minister or such person as he may authorise for the purpose, on receipt of the surveyor's report in respect of a cargo ship, is satisfied that the ship is eligible for exemption under this Act from any of the requirements of those of the Regulations applicable to the ship and to such voyages as it is to

Exemption Certificate and Qualified Cargo Ship Safety Construction Certificate.

be engaged on, and that it complies with the remainder of these requirements, he shall, on the application of the owner, issue in respect of the ship—

- (a) where it is of not less than five hundred gross tons and is to be engaged on international voyages—
  - (i) an Exemption Certificate stating from which of the requirements of the Safety Convention, the ship is exempt and that the exemption is conditional on the ship plying only on the voyages and being engaged only in the trades and complying with the other conditions specified in the certificate; and
  - (ii) a certificate showing that the ship complies with those requirements from which it is not exempt;
- (b) in any other case, a certificate showing that the ship complies with such of the requirements of the Cargo Ship Construction and Survey Regulations from which it is not exempt and to the voyages on which it is to be engaged, and any certificate issued under paragraph (a)(ii) or (b), is in this Act referred to as a “Qualified Cargo Ship Safety Construction Certificate”.

Validity period  
of Cargo Ship  
Safety  
Construction  
Certificate.

**256.** (1) A certificate issued under section 254 and a certificate issued under section 255 other than an Exemption Certificate, shall remain in force for five years or such shorter period as may be specified in it, but without prejudice to the power of the Minister to cancel it, and an Exemption Certificate issued under this section shall remain in force for the same period as the corresponding qualified certificate.

(2) The Minister may, by Order, extend the period for which a certificate under this subsection is issued to a period not exceeding six years.

(3) Without prejudice to the power of extension conferred under this Act, where a certificate under this section is in force in respect of a ship and the certificate was issued for a shorter period

that is allowed under this section, the Minister or any person authorised by him for the purpose may, if satisfied, on receipt of declarations of survey in respect of the ship that is proper to do so, grant an extension of the certificate for a period not exceeding one year and not exceeding, together with the period for which it has been previously extended under this subsection, the longest period for which it could have been issued under this Act.

**257.** Where following the survey of a ship, the owner feels aggrieved by the withholding of any certificate required to be carried on board the ship under this Act, or by his ship being detained in accordance with section 232, he may appeal to the Court of Survey established under section 390.

Appeals against withholding of certificates or detention of ship.

**258.** (1) A Passenger Ship Safety Certificate, a Radio Certificate or an Exemption Certificate stating that a ship is wholly exempt from the provisions of the Safety Convention relating to radio-telegraphy, radio-telephony and direction finders, shall be in force for one year and a Safety Equipment Certificate, shall be in force for two years from the date of its issue or for such shorter period as may be specified in the certificate; save that no such certificate shall remain in force after notice is given by the Minister to the owner, master or agent of the ship, in respect of which it has been issued that the Minister has cancelled the certificate.

Duration of certificates.

(2) An Exemption Certificate, other than a certificate stating that a ship is wholly exempt from the provisions of the Safety Convention relating to radio-telegraphy, radio-telephony and direction finders, shall be in force for the same period as the corresponding qualified certificate.

(3) Any certificate issued by the Minister under this Act, and any Passenger Ship Safety Certificate, whether or not combined in one document with any other safety certificate, shall be admissible in evidence.

**259.** (1) Where a Trinidad and Tobago ship is not in a port of Trinidad and Tobago on the date of expiry of any certificate issued to that ship under this Act, the Minister or any such person as he

Extension of validity of certificates.

may authorise for the purpose, may extend the validity of that certificate in the first instance by a period not exceeding one month from its initial date of expiry up to a maximum of three months in the aggregate.

(2) The extension referred to in subsection (1) shall be granted only for the purpose of enabling the ship to proceed to a port of Trinidad and Tobago or a port where it is to be surveyed for the purpose of renewal of such certificate, and then only where it appears proper and reasonable to grant the extension.

Validity of qualified certificates.

**260.** A qualified certificate shall not be deemed to be in force in respect of a ship unless there is in force in respect of the ship the corresponding exemption certificates; and an Exemption Certificate shall be of no effect unless it is, by its terms, applicable to the voyage on which the ship is about to proceed.

Penalty for non-compliance with conditions of Exemption Certificates.

**261.** Where an Exemption Certificate, issued in respect of any Trinidad and Tobago ship specifies conditions on which the certificate is issued and any of those conditions is not complied with, the owner or the master of the ship is guilty of an offence and is liable to a fine of five thousand dollars.

Posting of certificates.

**262.** (1) All certificates or certified copies thereof issued under this Act, except Exemption Certificates or certified copies thereof, shall be posted in a prominent and accessible place in the ship for the information of all persons on board; and the certificates or copies thereof shall be kept so posted while they are in force and the ship is in use.

(2) The owner or master of a ship who fails without reasonable cause to comply with this section is guilty of an offence and is liable to a fine of five hundred dollars.

Survey of ship in respect of which an accepted Safety Certificate is issued.

**263.** A surveyor of ships or any other marine officer may board any ship for the purpose of verifying—

- (a) that there is in force in respect of a foreign Safety Convention ship, a valid Safety Convention Certificate;

- (b) that the condition of the hull, equipment and machinery of any such Safety Convention ship corresponds substantially with the particulars shown in such a certificate;
- (c) that the number, grades and qualifications of radio officers or operators on board correspond with those shown in the certificate; except where the certificate states that the ship is wholly exempt from the provisions of the Safety Convention relating to radio-telegraphy and radio-telephony; or
- (d) that any conditions subject to which such a certificate, being the equivalent of an Exemption Certificate, is issued, are complied with.

**264.** (1) The master of every foreign Safety Convention ship, shall produce to the appropriate authorities from whom a clearance for the ship is demanded in respect of an international voyage from a port in Trinidad and Tobago, valid Safety Convention Certificates that are the equivalent of the Safety Convention Certificates issued by the Minister that would be required to be in force in respect of the ship if it was a Trinidad and Tobago ship, and a clearance shall not be granted, and the ship may be detained until those certificates are so produced.

Production of Safety Convention Certificate.

(2) The production of a valid Safety Convention Certificate being the equivalent of—

- (a) a qualified certificate; or
- (b) an Exemption Certificate, other than a certificate stating that the ship is wholly exempt from the provisions of the Safety Convention,

shall not avail for the purpose of section 265 unless there is also produced the corresponding Exemption Certificate or qualified certificate as the case may be.

**265.** (1) Where a valid Safety Convention Certificate is produced in respect of a foreign Safety Convention ship, it shall be accepted and the ship shall be exempted from surveys or inspections under section 263, unless there are clear grounds for

Miscellaneous privileges of ships holding Safety Convention Certificates.

believing that the condition of the ship or of its equipment does not correspond substantially with the particulars of the certificate or that the ship and its equipment are not in compliance with Regulations made under this Act respecting the maintenance of conditions of ships and their equipment after survey.

(2) Where a certificate is not acceptable due to the circumstances referred to in subsection (1), or if a certificate has expired or ceased to be valid, the ship shall not be granted clearance and shall be detained until it can proceed to sea or to the appropriate repair yard without causing danger to the ship or persons on board, and the following persons shall be notified in writing of the circumstances, namely:

- (a) the local Consul of the ship's flag State or, in his absence, the nearest diplomatic representative of the ship's flag State;
- (b) nominated surveyors or recognised organisations responsible for the issue of the certificates referred to in subsection (1).

(3) Where any ship referred to in subsection (2) is unduly detained or delayed, it shall be entitled to compensation for any loss or damage suffered as a direct result of such undue detention or delay.

Prohibition on proceeding to sea without appropriate certificate.

**266.** (1) No Trinidad and Tobago ship shall proceed to sea on an international voyage from a port in Trinidad and Tobago unless there is in force in respect of the ship—

- (a) where it is a passenger ship a Passenger Ship Safety Certificate, or a Short Voyage Safety Certificate, or a Qualified Short Voyage Safety Certificate which, subject to the provisions of this section relating to Short Voyage Certificates, is applicable to the voyage on which the ship is about to proceed and to the trade in which it is for the time being engaged;
- (b) where it is not a passenger ship—
  - (i) a Cargo Ship Safety Construction Certificate or a Qualified Cargo Ship Safety Construction Certificate;

- (ii) a Safety Equipment Certificate or a Qualified Safety Equipment Certificate; and
- (iii) a Radio Certificate, or a Qualified Radio Certificate, or an Exemption Radio Certificate.

(2) Notwithstanding the provision in subsection (1) a Trinidad and Tobago ship that is not a passenger ship may proceed to sea if there is in force in respect of that ship, such certificates as would be required if it were a passenger ship, namely, the certificates referred to in paragraph (a) of subsection (1).

**267.** The master of every Trinidad and Tobago ship shall produce to the appropriate authorities from whom a clearance for the ship is demanded for an international voyage the certificates required by this Part to be in force when the ship proceeds to sea and a clearance shall not be granted, and the ship may be detained, until the certificates are so produced.

Detention of ship for lack of production of certificates.

**268.** (1) Every Trinidad and Tobago passenger ship, regardless of size and every Trinidad and Tobago cargo ship having a length of twenty-four metres and upwards shall carry on board such information about the ship's stability as may be prescribed.

Ship's stability.

(2) The information, a copy of which shall be sent to the Minister, shall be based on the determination of the ship's stability by means of an inclining test of the ship but the Minister may allow the information to be based on a similar determination of the stability of a sister ship.

(3) Where any ship proceeds or attempts to proceed to sea without having on board the information as required by subsections (1) and (2), the owner or master is guilty of an offence and is liable to a fine of five thousand dollars.

**269.** Any person who—

- (a) knowingly and wilfully makes, or assists in making, or procures to be made a false or fraudulent survey report under this Part; or

Penalty for forgery of certificate of declaration.

- (b) forges, assists in forging, procures to be forged, fraudulently alters, assists in fraudulently altering any such report or certificate, or anything contained in or any signature to any such report or certificate,

is guilty of an offence.

Notice of alterations affecting the efficiency or seaworthiness of the ship.

**270.** (1) The owner or master of a passenger ship in respect of which a Passenger Ship Safety Certificate issued under this Act is in force shall, as soon as possible after any alteration is made in the ship's hull, equipment or machinery affecting the efficiency thereof or the seaworthiness of the ship, give written notice to the Director containing full particulars of the alteration.

(2) The owner or master of a ship, other than a passenger ship in respect of which any certificate issued under this Act is in force shall, as soon as possible, after any alteration is made in the appliances or equipment required by the Regulations for safety of life at sea, the Safety Convention or the Collision Regulations to be carried by the ship, being an alteration affecting the efficiency or completeness of those appliances or equipment, give written notice to the Director containing full particulars of the alteration.

(3) Where notice of any alteration is not given as required by this section, the owner or master of the ship is guilty of an offence and is liable to a fine of one thousand dollars.

Renewal of survey of ship ordered by the Director at any time.

**271.** (1) Where the Director has reason to believe that since the making of the last survey report in respect of any ship—

- (a) any alteration has been made as is mentioned in section 270;
- (b) the hull, equipment or machinery of a passenger ship have sustained any damage or are otherwise insufficient; or
- (c) the appliances or equipment of a ship, other than a passenger ship, have sustained any damage or are otherwise insufficient,

the Director may require the ship to be again surveyed to such extent as he thinks fit, and if such requirement is not complied with, may cancel any certificate issued in respect of the ship under this Act.

(2) For the purpose of this section “alteration” in relation to anything, includes the renewal or replacement of any part of it.

**272.** (1) The Minister may direct that this Part or any of the provisions thereof shall apply to any foreign ship or class of ship while within the waters of Trinidad and Tobago.

Application of this Part to foreign ships—exemption from compliance with this Part.

(2) Notwithstanding anything in this Part, the Minister may relieve any foreign ship or the owner of any such ship from compliance with any of the provisions of this Part or Regulations made thereunder relating to inspection, in any specific case of emergency where the Minister may deem it necessary or advisable in the public interest, to such extent and in such manner and upon such terms as he may consider proper in the circumstances; but the Minister shall not relieve any ship or the owner thereof from compliance with any such provision to such manner as would permit any ship to proceed to sea or to make any voyage in an unseaworthy condition.

**273.** (1) The Minister may, at the request of the Government of a State to which the Safety Convention applies, cause a ship to be surveyed, and if satisfied that the requirements of the said Convention are complied with, shall issue certificates to the ship in accordance with the Safety Convention.

Issue of accepted Safety Convention Certificates by the Minister in respect of foreign registered ships.

(2) Any certificate so issued shall contain a statement to the effect that it has been issued at the request of the Government of the country in which the ship is or will be registered, and it shall have the same force and receive the same recognition as a certificate issued under this Part.

**274.** The Minister may request the Government of a State to which the Safety Convention applies or any organisation authorised to act in that behalf by the Minister to issue in respect of a Trinidad and Tobago ship any certificate the issue of which is required under this Act; and a certificate issued in pursuance of such a request and containing a statement that it has been so issued shall have effect for the purposes of this Act as if it had been issued by the Minister and not by the Government of that State.

Issue of certificates by other Governments.

Exceptions.

**275.** The Safety Convention and the Regulations made thereunder, unless it is otherwise provided by those Regulations, shall not apply to—

- (a) ships of war or troopships;
- (b) cargo ships of less than five hundred gross register tons;
- (c) ships not propelled by mechanical means;
- (d) wooden ships of primitive build;
- (e) pleasure craft not engaged in trade;
- (f) fishing vessels;
- (g) such coastal trade ships as the Minister may prescribe;
- (h) licensed Trinidad and Tobago Ships.

Regulations for safety requirements and issue of local safety certificates.

**276.** The Minister may make Regulations prescribing safety requirements and providing for the survey and issue of local safety certificates in respect of any ship or class of ship to which the Safety Convention does not apply.

## PART XII

### LOAD LINES

Interpretation.

**277.** For the purposes of this Part—

“Convention Country” means a State, the Government of which is a party to the Load Line Convention and which has not denounced that Convention;

“existing ship” means a ship which is not a new ship;

“fishing vessel” means a ship used for catching fish, whales, seals, walrus or other living resources of the sea;

“Load Line Convention” means the International Convention on Load Lines 1966 and any amendments thereto which the Minister may, by Order declare to be in effect for Trinidad and Tobago;

“load line convention ship” means an international load line ship belonging to a country to which the Load Line Convention applies;

“Load Line Regulations” means the Regulations made by the Minister to give effect to the Load Line Convention;

“load line ship” means—

- (a) an international load line ship, that is to say, an existing ship of not less than one hundred and fifty gross tons or a new ship of twenty-four metres or more in length which carries cargo or passengers on international voyages; and
- (b) a local load line ship, that is to say, a ship, other than an international load line ship, which carries cargo or passengers;

“new ship” means a ship whose keel is laid or which is at a similar stage of construction on or after—

- (a) in the case of a ship registered in or flying the flag of a State other than Trinidad and Tobago which is a Convention State, the date from which it is declared that the Government of that State has ratified or acceded to the Load Line Convention, or that it is a State to which that Convention applies;
- (b) in the case of any other ship, the date of the coming into force of this Act.

**278.** This Part shall not apply to—

Exceptions.

- (a) ships of war;
- (b) pleasure craft not engaged in trade;
- (c) fishing vessels.

**279.** The Minister may from time to time by Notice publish a list of States that have ratified, acceded to or denounced the Load Line Convention.

States to which Load Line Convention applies.

**280.** The Minister may make such Regulations hereinafter referred to as the “Load Line Regulations” as appear to him to be necessary for the purpose of giving effect to the Load Line Convention, and without prejudice to the generality of the foregoing, such Regulations may also prescribe load line requirements and provide for the issue of local Load Line Certificates in respect of ships to which the Load Line Convention does not apply.

Minister to make Load Line Regulations to give effect to the Load Line Convention.

Certificates which can be issued under the Load Line Convention.

**281.** (1) An International Load Line Certificate may be issued to every ship which has been surveyed and marked in accordance with the Load Line Convention.

(2) An International Load Line Exemption Certificate may be issued to any ship to which an exemption has been granted in accordance with the Load Line Convention.

(3) The certificates mentioned in this section shall be issued by the Minister or by any person or organisation duly authorised by him, and in every case the Minister shall assume full responsibility for the certificates.

Issue of Load Line Certificates.

**282.** (1) Where a Trinidad and Tobago ship has been surveyed and marked in accordance with the Load Line Regulations, the appropriate certificate shall be issued to the owner of the ship, on his application.

(2) For the purposes of this section the appropriate certificate—

(a) in the case of an existing ship of not less than one hundred and fifty gross tons, and in the case of a new ship of twenty-four metres or more in length is to be called an “International Load Line Certificate (1966)”; and

(b) in the case of any other ship, is to be called a “Trinidad and Tobago Local Load Line Certificate”.

Certificates issued by other Governments.

**283.** (1) The Minister may request the Government of a State which is a party to the Load Line Convention to issue an International Load Line Certificate in respect of a Trinidad and Tobago ship, and a certificate so issued and containing a statement that it was so issued shall have effect for the purposes of this Part as if it had been issued by the Minister.

(2) Where a valid Load Line Certificate issued in pursuance of subsection (1) is produced in respect of a ship, that ship shall, for the purposes of this Part, be deemed to have been surveyed under the Load Line Regulations and, if the deck line and load lines correspond with the marks specified in the certificate, the ship shall be deemed to be marked as required by this Part.

**284.** The Minister may, at the request of the Government of a State to which the Load Line Convention applies, issue an International Load Line Certificate in respect of a ship of that State, if he is satisfied that, as in the case of a Trinidad and Tobago ship, he can properly issue the certificate; and where a certificate is issued at such a request, it shall contain a statement to the effect that it has been so issued.

Certificates issued by the Government of Trinidad and Tobago at the request of other Governments.

**285.** (1) With a view to determining the validity in Trinidad and Tobago of certificates purporting to have been issued in accordance with the Load Line Convention in respect of foreign ships, the Minister may make such Regulations as appear to him to be necessary.

Validity of foreign certificates.

(2) For the purposes of the provisions of this Part relating to foreign ships the expression “a valid Load Line Certificate” means a certificate complying with such of those Regulations made under subsection (1) as are applicable in the circumstances.

**286.** (1) Where in the opinion of the Minister the sheltered nature and conditions of international voyages between ports in Trinidad and Tobago and ports in neighbouring States make it unreasonable or impracticable to apply the provisions of this Act to ships plying on such a voyage, and the Minister is satisfied that the Governments of the other States concur in that opinion, the Minister may, by Order, specifying those ports, direct that ships plying on such voyages be exempt from the provisions of this Part.

Power to make exemption orders.

(2) The Minister may, by Order, direct that ships under twenty-four metres in length engaged solely in the coasting trade, or any class of such ships specified in the Order be exempt from the provisions of this Part.

(3) Any Order under this section may be made subject to such conditions as the Minister thinks fit; and where any such Order is made subject to conditions, the exemption granted by the Order shall not have effect in relation to a ship unless the ship complies with those conditions.

**287.** (1) On the application of the owner of a Trinidad and Tobago ship to which this Part applies and the ship is either an existing ship of not less than one hundred and fifty gross tons or

Further powers to exempt the ship.

a new ship of not less than twenty-four metres in length, the Minister may exempt the ship if in his opinion the ship embodies features of a novel kind such that, if the ship had to comply with all the requirements of this Part, the development of those features and their incorporation in the ship might be seriously impeded.

(2) On the application of the owner of a Trinidad and Tobago ship to which this Part applies, and which is either—

(a) an existing ship of less than one hundred and fifty gross tons or a new ship of less than twenty-four metres in length, or

(b) a ship, not falling within paragraph (a), which does not ply on international voyages,

the Minister may exempt the ship.

(3) Without prejudice to subsection (2), where a Trinidad and Tobago ship to which this Part applies is either an existing ship of not less than one hundred and fifty gross tons or a new ship of not less than twenty-four metres in length, does not normally ply on international voyages but is, in exceptional circumstances, required to undertake a single international voyage, the Minister, on the application of the owner of the ship, specifying the international voyage in question, may exempt the ship while engaged on that voyage.

(4) Any exemption granted under this section may be granted subject to such conditions as the Minister thinks fit; and where any such exemption is granted subject to conditions, the exemption shall not have effect unless those conditions are complied with.

Extent of exemption.

**288.** In this Part, any reference to exempting a ship is a reference to exempting the ship either—

(a) from all the provisions of this Part and of the Load Line Regulations; or

(b) from such of those provisions as are specified in the instrument granting the exemption.

Issue of Exemption Certificates.

**289.** (1) Where the Minister exempts a ship under section 286 or 287 the Director shall issue the appropriate certificate to the owner of the ship.

(2) For the purposes of this section, the appropriate certificate—

- (a) where the exemption is granted under subsection (1) or (3) of section 287 is to be called an “International Load Line Exemption Certificate”; and
- (b) where the exemption is granted under subsection (2) of that section is to be called a “Trinidad and Tobago Local Load Line Exemption Certificate”.

(3) Any certificate issued under this section shall be in such form, and shall be issued in such manner, as may be prescribed by the Load Line Regulations.

**290.** (1) The Load Line Regulations shall make provision for determining the period during which any exemption granted under section 286 or 287 or any certificate issued under section 289 is to remain in force including—

Duration and determination of exemptions, etc.

- (a) provision enabling the period for which any such exemption or certificate is originally granted or issued to be extended within such limits and in such circumstances as may be prescribed by the Regulations; and
- (b) provision for terminating any such exemption and for cancelling any such certificate in such circumstances as may be prescribed.

(2) While any such certificate is in force in respect of a ship, there shall be endorsed on the certificate such information relating to—

- (a) periodical inspections of the ship in accordance with the Load Line Regulations; and
- (b) any extension of the period for which the certificate was issued as may be prescribed by the Regulations.

**291.** Where a valid Load Line Certificate issued under this Part is produced in respect of the ship to which the certificate relates—

Effect of Load Line Certificates.

- (a) the ship shall be deemed to have been surveyed in accordance with the Load Line Regulations; and

- (b) where lines are marked on the ship according in number and description to the deck line and load lines as required by the Load Line Regulations, and the positions of those lines so marked correspond to the positions of the deck line and load lines as specified in the certificate, the ship shall be deemed to be marked as required by those Regulations.

Duration, renewal and cancellation of Load Line Certificate.

**292.** (1) Every Load Line Certificate issued by or under the authority of the Minister shall, unless it is renewed in accordance with the provisions of subsection (2), expire at the end of such period as specified therein but not exceeding five years from the date of its issue.

(2) Any such load line certificate may, after a survey that is not less effective than the survey required by the Load Line Regulations before the issue of the certificate, be renewed from time to time by the Director or by any person authorised by him to issue a load line certificate for such period not exceeding five years on any occasion as the Director or other authorised person renewing the certificate thinks fit.

(3) The owner of every ship in respect of which any such certificate remains in force, shall cause the ship to be surveyed in the prescribed manner at least once in every period of twelve months after the issue of the certificate for the purpose of ascertaining whether the certificate should remain in force, having regard to subsection (2), and if the ship is not so surveyed, the Minister shall cancel the certificate, but may, if he thinks fit extend the said period by a maximum of three months.

Ships not to proceed to sea without Load Line Certificate.

**293.** (1) Subject to any exemption granted by or under this Part, no Trinidad and Tobago ship being an international load line ship shall proceed to sea on an international voyage unless there is in force in respect of such ship an International Load Line Certificate.

(2) No Trinidad and Tobago ship, being a local load line ship shall proceed to sea unless there is in force in respect of such ship a Local Load Line Certificate.

(3) The master of every Trinidad and Tobago load line ship shall produce to the Customs officer from whom a clearance for the ship is demanded the certificate that is required by this section to be in force when the ship proceeds to sea; and a clearance shall not be granted and the ship shall be detained until that certificate is so produced.

**294.** (1) The Minister may make Regulations, in this section referred to as “the Deck Cargo Regulations”, prescribing requirements to be complied with where cargo is carried in any uncovered space on the deck of a load line ship. Deck cargo.

(2) Where the Load Line Regulations provide for assigning special freeboards to ships which are to have effect when carrying only timber deck cargo, then, without prejudice to the generality of subsection (1), the Deck Cargo Regulations may prescribe special requirements to be complied with in circumstances where any such special freeboard has effect.

(3) In prescribing any such special requirements as are mentioned in subsection (2), the Minister shall have regard in particular to the provisions of Chapter IV of Annex 1 to the Load Line Convention.

(4) Where any provisions of the Deck Cargo Regulations are contravened—

- (a) in the case of a Trinidad and Tobago ship; or
- (b) in the case of any other ship while the ship is within any port in Trinidad and Tobago,

the master of the ship is, subject to subsection (5), guilty of an offence and is liable to a fine of five thousand dollars.

(5) Where a person is charged with an offence under subsection (4) it shall be a valid defence if proven to the satisfaction of the Court that the contravention was due solely to deviation or delay caused by stress of weather or any other cause of *force majeure* which neither the master nor the owner nor the charterer if any, could have prevented or forestalled.

(6) For the purpose of securing compliance with the Deck Cargo Regulations, any person authorised in that behalf by the Director may inspect any ship to which this Part applies which is carrying cargo in any uncovered space on its deck; and for the purpose of any such inspection any such person shall have all the powers of a surveyor under this Act.

Inspection of  
Trinidad and  
Tobago load  
line ships.

**295.** A surveyor of ships or other marine officer may inspect any Trinidad and Tobago load line ship for the purpose of ensuring that the provisions of this Part have been complied with.

Alterations of  
the ship  
affecting the  
position of load  
lines.

**296.** (1) The owner or master of a ship in respect of which a load line certificate issued under this Part is in force shall, as soon as practicable after any structural alteration which affects the load line marks is made in the hull or superstructures of the ship, give notice in writing to the Director containing full particulars of the alteration.

(2) Where notice of any alteration is not given as required by subsection (1) the owner and the master are guilty of an offence and each is liable to a fine of five thousand dollars.

(3) The Director may exercise with respect to any such ship his powers specified in subsection (4) where he has reason to believe that—

- (a) material alterations have taken place in the hull or superstructure of the ship which affect the load line marks; or
- (b) fittings and appliances for the protection of openings, guard rails, the freeing ports or the means of access to the crews' quarters have not been maintained on the ship in as effective a condition as they were when the certificate was issued.

(4) In any such case the Director may—

- (a) cancel the Load Line Certificate; or
- (b) require the owner to have that ship surveyed again to such an extent as the Director thinks fit; and, if that requirement is not complied with he may cancel the Load Line Certificate.

(5) Where a load line certificate has expired or has been cancelled, the Director may require the owner or master of the ship to which the certificate relates to deliver up the certificate as he directs and the ship may be detained and if the owner or master fails without reasonable cause to comply with such requirement he is guilty of an offence and liable to a fine of one thousand dollars.

**297.** (1) No ship shall be so loaded as to submerge in salt water, when the ship has no list, the appropriate load line on each side of the ship, that is to say, the load line indicating or purporting to indicate the maximum depth to which the ship is for the time being permitted under the Load Line Regulations to be loaded.

Submersion of  
load lines.

(2) Where any ship is loaded in contravention of this section, the owner or master of the ship is guilty of an offence and is liable to a fine of one thousand dollars and to such additional fine, as specified in subsection (3), as the Court thinks fit to impose having regard to the extent to which the earning capacity of the ship was, or would have been increased by reason of the submersion.

(3) The said additional fine shall not exceed one thousand dollars for every centimetre or part thereof by which the appropriate load line on each side of the ship was submerged or would have been submerged if the ship had been in salt water and without any list.

(4) In any proceedings against an owner or master in respect of a contravention of this section, it shall be a valid defence that the contravention was due solely to deviation or delay caused by stress of weather or any other cause of *force majeure* which neither the master, the owner, nor the charterer, if any, could have prevented or forestalled.

(5) Without prejudice to any proceedings under this section, any ship which is loaded in contravention of this section may be detained until it ceases to be so loaded.

**298.** (1) The owner or master of a Trinidad and Tobago load line ship who fails without reasonable cause to keep the ship marked in accordance with this Part is guilty of an offence and is liable to a fine of one thousand dollars.

Alteration or  
defacement of  
marks.

(2) Any person who conceals, removes, alters, defaces or obliterates or permits any person under his control to conceal, remove, alter, deface or obliterate any mark placed on any ship in accordance with this Part, except with the authority of a person entitled under the Load Line Regulations to authorise the alteration of the mark is guilty of an offence and is liable to a fine of five thousand dollars.

Ships not to proceed to sea unless complying with Load Line Regulations.

**299.** (1) No Trinidad and Tobago load line ship shall proceed to sea unless—

- (a) the ship has been surveyed in accordance with the Load Line Regulations either by a surveyor of ships or by any organisation authorised to act in that behalf by the Minister or at his request by the Government of any Convention State;
- (b) the ship complies with the conditions for the assignment of load lines prescribed in the Load Line Regulations;
- (c) the ship is marked on each side with a mark (hereinafter referred to as a “deck-line”) indicating the position of the uppermost deck and with marks (hereinafter referred to as “load lines”), indicating the several maximum depths to which the ship is permitted to load in various circumstances prescribed by the Load Line Regulations; and
- (d) the deck-line and load lines are of the descriptions and in the positions required by the Load Line Regulations.

(2) Where the ship proceeds or attempts to proceed to sea in contravention of this section the master or owner thereof is liable to a fine of one thousand dollars and the ship may be detained until it has been so surveyed and marked.

Production of certificates to Customs.

**300.** The master of every load line convention ship shall, upon request, produce a valid Load Line Certificate to the Customs and Excise Officer from whom a clearance for the ship from a port in Trinidad and Tobago is demanded and a clearance shall not be granted and the ship may be detained until the certificate is produced.

**301.** Unless a valid Load Line Certificate is produced in respect of a foreign ship, the provisions of section 299 shall apply to that ship proceeding or attempting to proceed to sea from a port in Trinidad and Tobago as they apply to a Trinidad and Tobago ship.

Production of Load Line Certificate for foreign ships.

**302.** The provisions of section 297 shall apply to foreign ships while they are in the waters of Trinidad and Tobago as they apply to Trinidad and Tobago ships, subject to the following:

Applicability of rules as to submersion of load lines to foreign ships.

- (a) no load line convention ship shall be detained, and no proceedings shall be taken against the owner or master thereof, by virtue of that section, except after an inspection by a surveyor as provided for in this Part;
- (b) the expression “the appropriate load line” means—
  - (i) in the case where a valid load line convention certificate in respect of the ship is produced on such an inspection as aforesaid, the load line appearing by the certificate to indicate the maximum depth to which the ship is for the time being permitted under the Load Line Convention to be loaded;
  - (ii) in the case where a valid load line convention certificate is not so produced, the load line which corresponds with the load line indicating the maximum depth to which the ship is for the time being permitted in accordance with the Load Line Regulations to be loaded.

**303.** (1) Where a Load Line Certificate has been issued under this Part in respect of a Trinidad and Tobago load line ship—

Publication and display of Load Line Certificate and entry into log book of particulars of Load lines.

- (a) the owner of the ship shall forthwith upon receipt of the certificate, cause it to be framed and displayed in some conspicuous place on board the ship, and the certificate shall be kept so framed and displayed and shall be legible so long as the certificate remains in force and the ship is in use; and

(b) the master of the ship before making any other entry in any official log book, shall enter therein the particulars as to the markings of the deck-line and load line specified in the certificate.

(2) Before any Trinidad and Tobago load line ship proceeds to sea, the master thereof shall—

(a) enter in the official log book the draught and freeboard relating to the depth to which the ship is for the time being loaded, the density of the water in which the ship is floating and all other particulars relating thereto in the form as set out in the official log book;

(b) cause a notice in the prescribed form to be displayed in some conspicuous place on board the ship and the notice shall remain displayed and shall be legible while the ship is at sea.

(3) The master or owner of any Trinidad and Tobago load line ship who fails to comply with the provisions of this section is guilty of an offence and is liable to a fine of one thousand dollars.

Inspection of ships.

**304.** (1) A surveyor of ships or other marine officer may board any ship when such ship is within the waters of Trinidad and Tobago and may demand the production of any Load Line Certificate for the time being in force in respect of that ship.

(2) Where a valid Load Line Certificate is produced to the surveyor his powers of inspecting the ship with respect to load lines shall be limited to ensuring—

(a) that the ship is not loaded beyond the limits allowed by the certificate;

(b) that the markings of the load line on the ship correspond with those specified in the certificate;

(c) that no material alterations have taken place in the hull or superstructure of the ship which affect the markings of the load lines;

(d) that the fittings and appliances for the protection of openings, guard rails, freeing ports and the

means of access to the crew's quarters have been maintained on the ship in as effective a condition as they were when the certificate was issued.

(3) Where a valid Load Line Certificate is not produced to the surveyor, he shall have the same power of inspecting the ship as provided for in section 295 as if the ship were a Trinidad and Tobago load line ship.

**305.** (1) Where it is found upon an inspection referred to in section 304 that a ship is loaded in contravention of section 297, the ship may be detained and proceedings may be taken, against the master or owner thereof under section 297.

Contravention of Load Line Regulations and detention of ship.

(2) Where the load lines on the ship are not marked as specified in the certificate, the ship may be detained until the matter has been rectified to the satisfaction of the surveyor.

(3) Where on an inspection a ship is found to have been so materially altered in respect of the matters referred to in section 304(2)(c) or (d) that it is manifestly unfit to proceed to sea without danger to human life, the ship shall be detained; but where the ship has been so detained the Director shall order the ship to be released as soon as he is satisfied that the ship is fit to proceed to sea without danger to human life.

### PART XIII

#### CARRIAGE OF BULK CARGOES

**306.** The Minister may make Regulations relating to—

Minister may make Regulations.

- (a) the safe carriage and stowage of bulk cargoes having due regard to the Code of Safety Practice for Bulk Cargoes issued by the International Maritime Organisation and amendments thereto or replacements thereof;
- (b) the safe carriage and stowage of grain in compliance with the International Convention for the Safety of Life at Sea, 1974 and amendments thereto or replacements thereof as they come into force for Trinidad and Tobago.

Grain cargoes.

**307.** (1) Where grain is loaded on board any Trinidad and Tobago ship, or is loaded at any port in Trinidad and Tobago on any ship, all necessary and reasonable precautions shall be taken to prevent the grain from shifting; and, if such precautions are not taken, the owner or the master or any agent of the owner who was charged with the loading or with sending the ship to sea laden with the grain, is guilty of an offence and the ship shall be deemed for the purposes of this Act to be unsafe by reason of improper loading.

(2) Where any ship, loaded with grain outside Trinidad and Tobago without necessary and reasonable precautions having been taken to prevent the grain from shifting, enters any port in Trinidad and Tobago so laden, the owner or master is guilty of an offence and the ship shall be deemed for the purposes of this Act to be unsafe by reason of improper loading.

(3) No offence is committed under subsection (2) where the ship would not have entered any such port but for stress of weather or any other cause or *force majeure*, neither the master, the owner nor the charterer if any, could have prevented or forestalled.

(4) Any person authorised by the Director to ensure the observance of the provisions of this section may inspect the grain, and the mode in which it is stowed and shall have all the powers of a surveyor of ships under this Act.

Offence.

**308.** Any person who contravenes this Part is guilty of an offence and is liable to a fine of five thousand dollars.

#### PART XIV

#### DANGEROUS GOODS

Regulations as to dangerous goods.

**309.** (1) The Minister may by Regulations establish which goods, articles or materials to be carried in a ship are dangerous goods in accordance with the International Convention for the Safety of Life at Sea, 1974 relating to the carriage of dangerous goods and to amendments thereto or replacements thereof or with any other Convention which may be accepted by Trinidad and Tobago, and such Regulations shall have regard to the International Maritime Dangerous Goods (IMDG) Code of the International Maritime Organisation.

(2) Without restricting the generality of the foregoing, the Minister may by Regulations prescribe—

- (a) the method of packing and stowing such goods;
- (b) the quantity of such goods which may be carried in any ship;
- (c) the place or places within a ship in which they may be carried;
- (d) the marking that is to be placed on any package or container in which goods may be placed for shipment;
- (e) the precautions that shall be taken with respect to the carriage of such goods and the powers of inspection to determine compliance with the provisions of the Regulations.

**310.** (1) No person shall send by or carry in a Trinidad and Tobago ship, except in accordance with Regulations made pursuant to section 309, any dangerous goods, save that this section shall not apply to ship's distress signals or to the carriage of military stores under conditions authorised by the Minister.

Carriage of dangerous goods.

(2) No person except the owner or master shall send by or carry in a Trinidad and Tobago ship any dangerous goods without first distinctly marking their nature on the outside of the outermost package containing the same, in accordance with such Regulations as the Minister may make and without first giving written notice of the nature of such goods and of the name and address of the sender thereof to the master or owner of the ship.

(3) This section shall apply to all foreign ships while loading at any place in Trinidad and Tobago as they apply to Trinidad and Tobago ships.

**311.** A person who contravenes this Part is guilty of an offence and is liable to a fine of ten thousand dollars and the ship shall be deemed, for the purposes of this Act, to be unsafe by reason of improper loading.

Offence.

**312.** (1) The master or owner of any ship may refuse to take on board any package or parcel that he suspects might contain any dangerous goods; and may require the package to be opened to ascertain its nature.

Disposing of dangerous goods.

(2) When any dangerous goods, or any goods that, in the opinion of the master or owner of the ship, are dangerous goods, have been sent on board any ship without the marking or the written notice described in section 310, the master or owner of the ship may cause the goods, together with any package or container thereof, to be thrown overboard; and neither the master nor the owner of the ship is subject to civil or criminal liability in any Court in respect of such action.

Forfeiture of dangerous goods.

**313.** (1) Where any dangerous goods have been sent by or carried in any ship in a manner that would constitute an offence under this Part, a Court having admiralty jurisdiction may order the goods, and any packaging or container thereof, to be forfeited.

(2) A Court may exercise the powers conferred by subsection (1) notwithstanding—

- (a) that the owner of the goods concerned has not committed any offence in respect of the goods, or is not before the Court, or has had no notice of the proceedings; and
- (b) that there is no evidence to show to whom the goods belong,

but the Court may, in its discretion, require such notice as it may direct to be given to the owner or shipper of the goods before they are forfeited.

## PART XV

### SEAWORTHINESS OF SHIPS

Sending unseaworthy ship to sea.

**314.** (1) Any person who sends or is a party to sending a Trinidad and Tobago ship to sea in such an unseaworthy state that the life of any person is likely to be endangered thereby, is guilty of an offence, unless he proves either—

- (a) that he used all reasonable means to ensure that the ship was sent to sea in a seaworthy state; or
- (b) that sending the ship to sea in such an unseaworthy state was, under the circumstances, reasonable and justifiable.

(2) The master of a Trinidad and Tobago ship who knowingly takes a ship to sea in such an unseaworthy state that the life of any person is likely to be endangered thereby is guilty of an offence, unless he proves that taking the ship to sea in such an unseaworthy state was under the circumstances reasonable and justifiable.

**315.** (1) Notwithstanding any agreement to the contrary it is an implied term of every contract whether express or implied, relating to service on board a ship that—

Duty to ensure seaworthiness.

- (a) the owner of the ship;
- (b) the master; and
- (c) every agent charged with the loading of the ship or with the preparation of the ship for sea, or the sending of the ship to sea,

are bound to use all reasonable means to ensure the seaworthiness of the ship for the voyage at the time when the voyage commences and to keep the ship in a seaworthy condition throughout the voyage.

(2) Nothing in this section makes the owner of a ship liable by reason of the ship being sent to sea in an unseaworthy state when, owing to special circumstances, the sending of the ship to sea in that state was reasonable and justifiable.

**316.** (1) Where, whether on a complaint or representation made to him or otherwise, the Director or a surveyor has reason to believe that any Trinidad and Tobago ship, or any foreign ship at a port in Trinidad and Tobago, is an unseaworthy ship, he shall, if the complaint or representation is made in sufficient time before the sailing of the ship, ascertain whether or not the ship ought to be detained.

Detention of unseaworthy ship.

(2) Where the Director or surveyor is satisfied that the ship is an unseaworthy ship, he may—

- (a) in the case of any ship, cause the ship to be detained; and
- (b) in the case of a Trinidad and Tobago ship, cause its Certificate of Registry to be suspended, until he is satisfied that the ship is fit to proceed to sea.

(3) Where the ship is detained pursuant to subsection (2), the Director may adopt any measures or means he thinks suitable or necessary to prevent the ship from sailing while it is an unseaworthy ship.

(4) Where a foreign ship has been detained under this section, a consular officer for the State to which the ship belongs shall be informed forthwith.

(5) Where a ship has been dealt with under this section, the ship may be inspected or surveyed by a surveyor or other marine officer to investigate any defects or deficiencies believed to exist.

(6) The owner or master of a ship or a consular officer referred to in subsection (4) may require that a person of his choice accompany any person making an inspection or survey under this section.

(7) The surveyor or any other marine officer acting under this section, shall as soon as practicable after action is completed in connection therewith, forward a full report thereof to the Director together with copies of any reports made upon inspection or survey.

(8) Any complaint in respect of the seaworthiness of a ship shall be in writing, stating the name and address of the complainant, and a copy of the complaint, including the name and address of the complainant, shall be given to the owner or master of the ship if action is taken under this section.

(9) In this Part “unseaworthy ship” means a ship that is by reason of the defective condition of its hull, equipment or machinery, or by reason of undermanning, overload or improper loading, unfit to proceed to sea without serious danger to human life, having regard to the nature of the service for which the ship is intended.

Liability for costs, damages.

**\*317.** (1) Where a ship is detained under this Act, and the ship was, at the time of detention, an unseaworthy ship within the meaning of this Part, the owner of the ship is liable to pay to the Minister any costs of and incidental to the detention and survey of the ship; and those costs are without prejudice to any other remedy, recoverable in the same manner as salvage.

\* See regulation 10 of the Shipping (Provisions and Water) Regulations, 1993 (LN 144/1993) contained in this Chapter.

\*(2) Where it is proved that there was no reasonable and probable cause, by reason of the condition of the ship or the act or default of the owner, for the detention of an unseaworthy ship, the Minister is liable to pay to the owner of the ship—

- (a) the owner's costs of and incidental to the detention and survey of the ship; and
- (b) compensation for any loss or damage sustained by the owner by reason of the detention or survey.

**318.** Where a ship is detained in consequence of a frivolous or vexatious complaint and the circumstances are such that the Minister becomes liable under this Part to pay to the owner of the ship any costs or compensation, the complainant shall be liable to pay to the Minister all such costs and compensation as the Minister incurs or is liable to pay in respect of the detention and survey of the ship.

Complainant liability.

**319.** (1) Where a complaint is made to the Minister, the Director or a surveyor, that a Trinidad and Tobago ship is unseaworthy, the Minister, or Director may, if he thinks fit, require that security to his satisfaction be given by the complainant for the costs and compensation that the complainant may become liable to pay under section 318.

Security for costs.

- (2) The security may not be required when the complaint—
  - (a) is made by one-fourth, being not less than three, of the seamen belonging to the ship; and
  - (b) is not frivolous or vexatious in the opinion of the Minister.

## PART XVI

### WRECKS AND SALVAGE

**320.** (1) The Principal Receiver of Wreck shall exercise general direction and supervision over all matters relating to receivers, wrecks and salvage.

Power of Principal Receiver of Wreck and designation of receivers.

(2) There may be designated by the Minister any person to be a receiver of wreck in any specified area and to perform the duties of a receiver under this Part.

\* See regulation 10 of the Shipping (Provisions and Water) Regulations, 1993 (LN 144/1993) contained in this Chapter.

Fees of receiver of wreck.

**321.** (1) There shall be paid to every receiver the expenses properly incurred by him in the performance of his duties, and also such fees as may be prescribed in respect of such other matters as may be prescribed, and the receiver shall not be entitled to any other remuneration.

(2) A receiver shall, in addition to all other rights and remedies for the recovery of the expenses and fees referred to in subsection (1), have the same rights and remedies in respect thereof as a salvor has in respect of salvage due to him and may, if the property in respect of which any such expenses and fees are due is not under arrest in any Court, seize or detain the property until his expenses and fees are paid, or until security is given therefor to his satisfaction.

(3) All fees received by a receiver in respect of any services performed by him shall be accounted for to the State and shall be applied in defraying any expenses duly incurred in carrying this Part into effect and, subject to such application, shall be paid to the Comptroller of Accounts.

Vessels in receiver of wreck.

**322.** (1) Where any vessel is wrecked, stranded or in distress in the waters or on the shores of Trinidad and Tobago, the receiver nearest to the area in which the wreck is situated shall, forthwith proceed there, and upon his arrival shall take charge of all persons present and shall assign such duties and give such directions to each person as he thinks fit for the preservation of the vessel and of the lives of the shipwrecked persons and of the cargo and apparel of the vessel.

(2) The receiver shall not interfere with the master or the crew of the vessel in respect of the management of the vessel, unless he is requested to do so by the master.

Power of receiver of wreck.

**323.** (1) A receiver may, with a view to the preservation of shipwrecked persons, or of a vessel, cargo or apparel—

- (a) require such persons as he thinks necessary to assist him;
- (b) require the master or other person having the charge of any vessel near at hand, to give such assistance with his men or vessel, as he is able to;

(c) require the use of any available machinery, vehicle or equipment.

(2) A receiver may cause to be apprehended and kept in custody until he can be conveniently taken before a Magistrate to be dealt with in accordance with the law, any person who plunders, creates disorder or obstructs the preservation of a vessel wrecked, stranded or in distress in the waters or on the shores of Trinidad and Tobago and may use reasonable force for the suppression of such plundering, disorder or obstruction and may require the assistance of persons in the vicinity.

**324.** (1) When a vessel is wrecked, stranded or in distress, any person may for the purpose of rendering assistance to the vessel, its cargo or apparel, or of saving the life of any person—

Power to pass over adjoining lands.

- (a) pass and repass, with or without vehicles, machinery or equipment, over any adjoining lands unless there is some public road equally convenient; and
- (b) deposit on those lands any cargo or other articles recovered from the vessel,

without being impeded or hindered or being subject to liability for trespass by the owner or occupier, but such person may not cause any more damage to the adjoining lands than is reasonably necessary for the purpose of rendering that assistance.

(2) Any damage sustained by an owner or occupier in consequence of the exercise of the rights conferred by subsection (1) is a charge on the vessel, cargo or articles in respect of or by which the damage is caused, and the amount payable in respect of the damage shall, in case of dispute, be determined and shall, in default of payment, be recoverable in the same manner as salvage under this Part.

- (3) An owner or occupier of land who—
  - (a) impedes or hinders any person in the exercise of the rights conferred by subsection (1);
  - (b) impedes or hinders the deposit of any cargo or other article recovered from the vessel on any land; or

- (c) prevents or endeavours to prevent any such cargo or other article from remaining deposited on the land for a reasonable time until it can be removed to a safe place of public deposit,

is guilty of an offence and is liable to a fine of one thousand dollars.

Immunity of receiver.

**325.** Where during any time a receiver or a person acting under his orders is engaged in the execution of the duties imposed on the receiver by this Part, some other person resists the receiver and a person is killed, maimed or hurt by reason of that resistance, no action, suit or prosecution against the receiver or person acting under his orders is maintainable by or on behalf of the person killed, maimed or hurt, unless the receiver or person acting under his orders used more force than was reasonably necessary in the circumstances.

Obstruction of receiver.

**326.** Every person who—

- (a) without reasonable cause fails to comply with any lawful request or order of a receiver; or  
(b) wilfully impedes or obstructs a receiver or any person acting under his orders in the execution of his duty,

is guilty of an offence and is liable to a fine of five thousand dollars and to imprisonment for six months.

Duties of persons finding wreck.

**327.** (1) Where any person finds or takes possession of any wreck within Trinidad and Tobago or brings within Trinidad and Tobago any wreck found outside Trinidad and Tobago he shall, where he is the owner thereof, give notice to the receiver of the area stating that he has found or taken possession of the same, and describing the marks by which the same may be recognised, or where he is not the owner thereof, as soon as possible, deliver the same to the receiver of the area.

(2) The Minister may dispense with a delivery required under subsection (1) in the case of any wreck upon such condition as he thinks fit.

(3) A person who fails without reasonable cause to comply with this section is guilty of an offence and is liable to a fine of five thousand dollars and shall, in addition, if he is not the owner, forfeit any claim to salvage and is liable to pay to the owner of the wreck, if it is claimed, or to the State, if it is unclaimed, double the value thereof to be recoverable in the same manner, as a fine imposed under this Act.

**328.** Where a receiver takes possession of any wreck, he shall, within forty-eight hours, cause to be displayed at such public place as the Director may deem appropriate nearest to the place where the wreck was found or seized by, or delivered to him, and otherwise publish in such manner as he may deem fit, a description of the wreck and of any marks by which it is distinguished, and send a copy of such description to the Principal Receiver. Notice of wreck.

**329.** (1) The owner of any wreck in the possession of the receiver or the agent of the owner shall— Claims of owners to wreck.

- (a) upon establishing his claim to the wreck to the satisfaction of the receiver within six months after the time at which the wreck came into the possession of the receiver; and
- (b) upon paying the Customs duty, if any, and the salvage fees and expenses due,

be entitled to have the wreck or the proceeds thereof delivered up to him.

(2) Where any articles belonging to or forming part of a foreign ship which has been wrecked in the waters or on the shores of Trinidad and Tobago or, belonging to and forming part of the cargo of any such ship, are found on or near the shores or are brought within any port in Trinidad and Tobago, the consular officer of the State to which the ship or, in the case of cargo, to which the owner of the cargo may have belonged shall, in the absence of the owner and of the master or other agent of the owner, be deemed to be the agent of the owner so far as the custody and disposal of the articles or of the ship is concerned under like circumstances.

Sale of wreck in certain cases.

**330.** (1) The Principal Receiver may at any time sell any wreck in the custody of a receiver where—

- (a) in his opinion, it is under the value of five thousand dollars;
- (b) in his opinion it is damaged to such an extent or is of so perishable a nature that it is not worthwhile to retain;
- (c) in his opinion it is not of sufficient value to pay for storage; or
- (d) it has not been removed within a time, specified by the Receiver.

(2) The proceeds of any sale made under subsection (1) shall, after defraying the expenses thereof, be held by the Principal Receiver for the same purposes and subject to the same claims, rights and liabilities as if the wreck had remained unsold.

Unclaimed wreck.

**331.** The State is entitled to all unclaimed wreck within any part of Trinidad and Tobago or found or taken possession of outside Trinidad and Tobago and brought within Trinidad and Tobago except in any place where the State has granted to any person the right to any such wreck.

Sale of unclaimed wreck.

**332.** Where no owner establishes a claim to any wreck in the possession of a receiver within six months after it came into his possession, the Principal Receiver may sell the wreck and shall pay the proceeds of the sale to the Comptroller of Accounts after—

- (a) deducting therefrom the expenses of the sale and any other expenses incurred by him; and
- (b) paying therefrom to the salvors such amount of salvage as the Minister in each case determines.

Discharge of receiver.

**333.** Upon delivery of the wreck by a receiver, or payment of the proceeds of sale of the wreck by the Principal Receiver under this Part, he shall be discharged from all liability in respect thereof but such delivery shall not prejudice or affect any question which may be raised by third parties concerning the right or title to the wreck or concerning the title to the land on which the wreck was found.

**334.** (1) Subject to any written law relating to ports or harbours where any vessel is sunk, stranded or abandoned in a port or harbour or its approaches in such manner as in the opinion of the competent authority is or is likely to become an obstruction or danger to navigation, that authority may —

Removal of wreck being a hindrance to navigation.

- (a) take possession of and raise, remove or destroy the whole or any part of the vessel;
- (b) light or buoy any such vessel or part thereof until it is raised, removed or destroyed; and
- (c) subject to subsections (2) and (3), sell in such manner as the authority thinks fit, any vessel or part thereof so raised or removed, and also any other property recovered in the exercise of its powers under this section and out of the proceeds of the sale, reimburse itself for the expenses incurred by it in relation thereto under this section and shall hold any surplus of the said proceeds on deposit for payment to the persons thereafter establishing a right thereto; but the deposit shall be paid to the Comptroller of Accounts unless the person entitled to the proceeds or any part thereof makes his claim within one year after the sale of the vessel.

(2) A sale shall not, except in the case of property which is of a perishable nature or which would deteriorate in value by delay, be made under this section until at least seven days' notice of the intended sale has been given in the *Gazette*.

(3) At any time before any property is sold under this section, the owner thereof shall be entitled to have the same delivered to him on payment to the Principal Receiver of the fair market value thereof, to be ascertained by agreement between the authority and the owner, or failing such agreement, by some person to be named for the purpose by the Principal Receiver and the sum paid as the value of any property under this subsection shall, for the purposes of this section, be deemed to be the proceeds of sale of that property.

(4) Where the proceeds of any sale referred to in this section are less than the costs incurred by the authority under subsection (1), the authority may recover the difference from the owner of the vessel as a debt due to the authority.

(5) In this section, “competent authority” or “authority” means the Director, the Principal Receiver and such other body or person as provided by any written law.

Breaking up and removing wreck.

**335.** (1) Where any person being the owner of any vessel or any wrecked, submerged, sunken or stranded vessel, or the duly authorised agent or servant of such owner is desirous of breaking up such vessel prior to removal thereof from Trinidad and Tobago, such person shall, before commencing salvage or breaking up operations, obtain the written permission of the Principal Receiver.

(2) The Principal Receiver in granting permission under subsection (1) may in his discretion—

- (a) stipulate such conditions as he considers necessary to minimise the risks, or effects of any pollution; and
- (b) require security in such reasonable amount as he may consider necessary to ensure the safe and effective removal of such vessel or any portion thereof.

(3) Any person who without the previous written permission of the Principal Receiver does or causes to be done any salvage or breaking up operation of any vessel or any wrecked, submerged, sunken or stranded vessel lying within Trinidad and Tobago is guilty of an offence and is liable to a fine of five thousand dollars and to six months imprisonment.

Extent of power of removal.

**336.** The provisions of this Part relating to the removal of wrecks shall apply to every article or thing being or forming part of the tackle, equipment, cargo, stores or ballast of a vessel.

Offences related to wreck.

**337.** Any person who takes into any foreign port and there sells any vessel, whether stranded, derelict or otherwise in distress,

found in Trinidad and Tobago or any part of the cargo or apparel thereof or anything belonging thereto, or any wreck found in Trinidad and Tobago is guilty of an offence and is liable to a fine of five thousand dollars and to imprisonment for six months.

**338.** (1) A person shall not, without the leave of the owner or master, board any vessel which is wrecked, stranded or in distress unless that person is authorised by a receiver, and where a person contravenes this section he is guilty of an offence and is liable to a fine of one thousand dollars and may be removed by force.

Unauthorised  
boarding of  
wreck.

(2) Where a person refuses to allow any person duly authorised by a receiver to board any wreck he is guilty of an offence and is liable to a fine of one thousand dollars.

**339.** (1) A person shall not—

- (a) impede or hinder the salving of any vessel stranded or in danger of being stranded or otherwise in distress within Trinidad and Tobago or of any part of the cargo or apparel thereof or of any wreck;
- (b) conceal any wreck or deface or obliterate any marks thereon; or
- (c) wrongfully remove any part of a vessel stranded or in danger of being stranded or otherwise in distress within Trinidad and Tobago or any part of the cargo or apparel thereof, or any wreck.

Interfering with  
wreck.

(2) A person who contravenes subsection (1) is guilty of an offence and is liable to a fine of one thousand dollars.

**340.** (1) Where a receiver suspects or receives information that any wreck is secreted or in the possession of some person who is not the owner thereof, or that any wreck is being otherwise improperly dealt with, he may apply to a Magistrate for a search warrant and the Magistrate may grant such a warrant and the receiver, by virtue thereof, may enter any house or other place wherever situated and also any vessel and search for, seize and detain any such wreck found there.

Summary  
procedure for  
concealment of  
wreck.

(2) Where any such seizure or detention of wreck is made in consequence of information given by any person to a receiver, the informer is entitled, by way of salvage, to such sum not exceeding in any case one hundred dollars as the receiver may allow.

Taking wreck at the time of casualty.

**341.** (1) Where a ship is wrecked, stranded or in distress within Trinidad and Tobago any cargo or other articles belonging to the ship which are washed ashore or otherwise lost or taken from the ship shall be delivered to a receiver.

(2) Any person, whether or not the owner of any cargo or article, referred to in subsection (1) who—

(a) conceals or keeps possession of any such cargo or article; or

(b) refuses to deliver any such cargo or article to a receiver or any person authorised by the receiver to demand such cargo or article,

is guilty of an offence and is liable to a fine of one thousand dollars.

(3) A receiver or any person authorised by the receiver to demand the delivery to him of any cargo or article referred to in subsection (1) may take such cargo or article by force from any person refusing to deliver it to him.

Salvage payable for saving life.

**342.** (1) Where services are rendered wholly or in part within Trinidad and Tobago in saving life from any aircraft, vessel, or wreck, or elsewhere in saving life from any Trinidad and Tobago vessel or aircraft, there shall be payable to the salvor by the owner of such aircraft, vessel or wreck a reasonable amount of salvage, including expenses properly incurred, to be determined in cases of dispute, in the manner hereinafter mentioned.

(2) Salvage payable in respect of the preservation of life shall be payable in priority to all other claims for salvage.

Salvage of vessel, cargo or wreck.

**343.** Where a vessel is wrecked, stranded or in distress within Trinidad and Tobago and services are rendered—

(a) by a person in assisting the vessel or saving the cargo or apparel of the vessel or any part thereof; or

- (b) by a person, other than a receiver, in saving any wreck,

there shall be payable to such person by the owner of the vessel, cargo, apparel or wreck a reasonable amount of salvage, to be determined in case of dispute in the manner set out in this Part.

**344.** Nothing in section 342 or 343 shall entitle a person to remuneration— Exclusion of remuneration.

- (a) in respect of services rendered contrary to an express and reasonable prohibition of such services by the master of the vessel to which such services are rendered;
- (b) in respect of services rendered by a tug to or for the vessel which it is towing or the cargo thereof, except where such services are so exceptional as to fall outside the scope of the contract of towage;
- (c) where he has caused the distress giving rise to the salvage, either intentionally or through negligence; or
- (d) where and to such extent as it appears that he has concealed or unlawfully disposed of any property salvaged.

**345.** (1) A dispute as to the amount of salvage, whether of life or property and whether the services for which it is claimed have been rendered within or without Trinidad and Tobago, arising between the salvor and the owner of any vessel, cargo, apparel or wreck shall, if not settled by agreement, arbitration or otherwise, in the following cases: Determination of salvage disputes.

- (a) where the parties to the dispute consent;
- (b) where the amount claimed does not exceed five thousand dollars;
- (c) where the value of the property saved does not exceed five thousand dollars,

be referred to and determined by the Magistrate's Court having jurisdiction at or near the place where the wreck was found, or in the case of services rendered, at or near the port in Trinidad and Tobago into which the vessel is first brought after the occurrence by reason whereof the claim of salvage arose.

(2) Subject to subsection (1), any dispute as to salvage shall be determined by the High Court but if the claimant does not recover in that Court more than five thousand dollars, he shall not be entitled to recover any costs, charges or expenses incurred by him in the pursuance of his claim, unless that Court certified that the case was a fit one to be tried otherwise than in the manner provided by subsection (1).

(3) A dispute relating to salvage may be determined on the application either of the salvor or of the owner of the property saved, or of their respective agents.

(4) The Court or arbitrators to whom a dispute as to salvage is referred for determination may for the purpose of determining any such dispute call to their assistance as an assessor, any person knowledgeable in maritime affairs and there shall be paid as part of the costs of the proceedings to every such assessor in respect of his services such sum as may be prescribed.

Rescission of salvage agreements.

**346.** Every agreement relating to salvage entered into urgently and under threat of danger may, at the request of either party thereto, be annulled or modified by the High Court where the High Court considers that the terms and conditions of such agreement are not reasonable.

Valuation of property.

**347.** (1) Where any dispute as to salvage arises, the Principal Receiver may, on the application of either party, appoint a valuer to value that property and shall give copies of the valuation to both parties.

(2) A copy of the valuation purporting to be signed by the valuer and certified as a true copy by the Principal Receiver shall be admissible as evidence in any subsequent proceedings.

(3) There shall be paid in respect of the valuation by the person applying for the same such fee as may be prescribed.

Detention of property liable to salvage.

**348.** (1) Where salvage is due to any person under this Act, the Principal Receiver shall—

- (a) where the salvage is due in respect of services rendered in assisting any vessel or in saving life therefrom or in saving the cargo or apparel thereof, detain the vessel and cargo or apparel; and

(b) where the salvage is due in respect of the saving of any wreck and the wreck is not sold as unclaimed under this Act, detain the wreck.

(2) Subject to provisions hereinafter mentioned, the Principal Receiver shall detain the vessel and the cargo and apparel, or the wreck (hereinafter referred to as “detained property”), until payment is made for salvage or process is issued for the arrest or detention thereof by a Court of competent jurisdiction.

(3) A Principal Receiver may release any detained property where security is given to his satisfaction save that where the claim for salvage exceeds five thousand dollars the Court shall be satisfied as to the adequacy of the security.

(4) Any security given for salvage under this section in an amount exceeding five thousand dollars may be enforced by the High Court in the same manner as if bail had been given in that Court.

**349.** (1) The Principal Receiver may sell any detained property where the persons liable to pay the salvage in respect of which the property is detained are aware of the detention in the following cases, namely:

Sale of detained property.

- (a) where the amount is not disputed and payment of the amount due is not made within twenty days after the amount is due;
- (b) where the amount is disputed, but no appeal lies from the decision of the first Court to which the dispute is referred and payment is not made within twenty days after the decision of the first Court; or
- (c) where the amount is disputed and an appeal lies from the decision of the first Court to which the dispute is referred to some other Court and within sixty days of the decision of the first Court, neither payment of the sum due is made nor proceedings are commenced for the purpose of the appeal.

(2) The proceeds of sale of detained property shall, after payment of the expenses of the sale, be applied by the Principal Receiver in payment of the expenses, fees and salvage, and, so far as not required for that purpose, shall be paid to the owners of the property, or any other persons entitled to receive the same.

Apportionment of salvage in relation to foreign vessel.

**350.** Where any dispute arises as to the apportionment of any amount of salvage among the owners, master, pilot, crew and other persons in the service of any foreign vessel, the amount shall be apportioned by the Court or person making the apportionment in accordance with the law of the country to which the vessel belongs.

Apportionment of salvage by receiver.

**351.** (1) Where the aggregate amount of salvage payable in respect of salvage rendered in Trinidad and Tobago has been finally determined and does not exceed five thousand dollars but a dispute arises as to the apportionment thereof among several claimants, the person liable to pay such amount may apply to the Principal Receiver to pay such amount to him.

(2) The Principal Receiver may, where he thinks fit, receive the amount referred to in subsection (1), and shall grant to the person paying the amount a certificate of the amount paid and of the service in respect of which it is paid.

(3) A certificate granted under subsection (2) in respect of any amount shall be a full discharge and indemnity to the person by whom the amount is paid and to his vessel, cargo, apparel and effects, against the claims of all persons in respect of the services mentioned in the certificate.

(4) The Principal Receiver shall with due despatch distribute any amount received by him under this section among the persons entitled thereto on such evidence and in such shares and proportions as he thinks fit and may retain any money which appears to him to be payable to any person who is absent.

(5) A distribution of any amount made by the Principal Receiver under this section shall be final and conclusive as against all persons claiming to be entitled to any portion of the amount distributed.

Apportionment by the High Court.

**352.** Whenever the aggregate amount of salvage payable has been finally ascertained and any delay or dispute arises as to the apportionment thereof, the High Court—

(a) may cause such amount to be apportioned among the persons entitled thereto in such manner as the

Court considers just, and may for that purpose, if it considers fit, appoint any person to carry out that apportionment;

- (b) may compel any person in whose hands or under whose control the amount may be to distribute such amount or to bring it into the Court to be dealt with as the Court directs; and
- (c) may for the purpose aforesaid issue such orders as it considers fit.

**353.** (1) Where salvage services are rendered by or on behalf of the State or with the aid of State property, the Principal Receiver shall be entitled to claim salvage on behalf of the State in respect of those services to the same extent as any other salvor and shall have the same rights and remedies in respect of those services as any other salvor.

Salvage services rendered by State.

(2) No claim shall be made for a receiver's fee or expenses if salvage is claimed on behalf of the State other than fees or expenses which may be included in such salvage claim.

(3) Any portion of a salvage award made to the State and due to a receiver or any other State employee shall be for that person's own benefit.

**354.** No action shall be instituted in respect of any salvage services unless proceedings therein are commenced within two years after the date when the salvage services were rendered; but the Court may extend any such period to such extent and on such conditions as it considers fit.

Time limit for salvage proceedings.

**355.** (1) All wreck being foreign goods brought or coming into Trinidad and Tobago shall be subject to the same duties as those to which such goods would be subject if they were imported into Trinidad and Tobago.

Provisions as to duties on wrecked goods.

(2) If any question arises as to the origin of any goods referred to in subsection (1), they shall be deemed to be the product of such country as the Comptroller of Customs and Excise may on investigation determine.

(3) The Comptroller of Customs and Excise shall permit all goods, wares or merchandise saved from any ship stranded or wrecked on its outward voyage to be returned to the port at which they were shipped, but shall take security for the due protection of the Consolidated Fund in respect of these goods.

## PART XVII

## PASSENGER SHIPS

Power of the Minister to make Regulations respecting passenger ships.

**356.** (1) The Minister may make Regulations—

- (a) respecting accommodation, facilities and provisions on board passenger ships which carry passengers from a port in Trinidad and Tobago;
- (b) requiring the preparation and furnishing of particulars as to all passengers to or from a port in Trinidad and Tobago;
- (c) regulating the number of passengers which a ship may carry from a port in Trinidad and Tobago whether or not the ship is a passenger ship; and
- (d) prescribing the terms and conditions upon which ships may carry passengers between ports in Trinidad and Tobago.

(2) In making Regulations pursuant to subsection (1), the Minister shall have due regard to the International Convention on the Carriage of Passengers and their Baggage by Sea 1974.

(3) The Minister may waive or vary the Regulations referred to in subsection (1) in respect of their application to licensed Trinidad and Tobago passenger ships operating solely within the waters of Trinidad and Tobago.

Offences in connection with passenger ships.

**357.** (1) Any person on board or attempting to board a passenger ship in Trinidad and Tobago is guilty of an offence who—

- (a) on account of being drunk and disorderly is, either refused admission to a passenger ship or where he is already on board, is requested by the owner or any person in his employ to leave the ship, and

- after having the amount of any fare paid by him returned or tendered to him, nevertheless persists in attempting to enter the ship, or where he is already on board, does not leave the ship;
- (b) after warning by the master or other officer of the ship, molests or continues to molest any passenger;
  - (c) on account of the ship being full, is either refused admission to a passenger ship, or where he is already on board, is requested by the owner or any person in his employ to leave the ship, and after having the amount of any fare paid by him returned or tendered to him, nevertheless persists in attempting to enter the ship, or where he is already on board, does not leave the ship;
  - (d) travels or attempts to travel in the ship without first paying his fare and with intent to avoid payment thereof;
  - (e) having paid his fare for a certain distance, knowingly and wilfully proceeds in the ship beyond that distance without first paying the additional fare for the additional distance, intending to avoid payment thereof;
  - (f) on arriving in a ship at a point to which he has paid his fare, knowingly refuses or neglects to leave the ship;
  - (g) fails, when requested by the master or other officer thereof, either to pay his fare or exhibit such ticket or other receipts showing the payment of his fare as is usually given to persons travelling by and paying their fare for the ship; or
  - (h) wilfully does or causes to be done anything in such a manner as to obstruct or injure any part of the machinery or tackle of the ship, or to obstruct, impede or molest the crew or any of them in the navigation or management of the ship or otherwise in the execution of their duty on or about the ship.

(2) A person who is guilty of an offence under this section is liable to a fine of five hundred dollars and to imprisonment for fourteen days.

## PART XVIII

## LIMITATION AND DIVISION OF LIABILITY

Interpretation.

**358.** (1) For the purpose of this Part—

“ship” includes every description of lighter, barge or like vessel, however propelled and any structure launched and intended for use in navigation as a ship or as a part of a ship; and

“unit of account” means a unit of value referred to in section 2 of Article XXI of the Articles of Agreement of the International Monetary Fund being the First Schedule of the International Financial Organisation Act.

Ch. 70:01.

(2) The value of the Trinidad and Tobago dollar in terms of the special drawing right shall be calculated in accordance with the method of valuation applied by the International Monetary Fund in effect at the date in question for its operations and transactions.

Limitation of liability of shipowners.

**359.** (1) Where any of the following events occur without the actual fault or privity of the owner of a ship, whether or not it is a Trinidad and Tobago ship, namely:

- (a) where any loss of life or personal injury is caused to any person on board that ship;
- (b) where any damage or loss is caused to any goods, merchandise or other things whatsoever on board that ship;
- (c) where any loss of life or personal injury is caused to any person not on board that ship through—
  - (i) the act or omission of any person, whether on board that ship or not, in the navigation or management of the ship, in the loading, carriage or discharge of its cargo or in the embarkation, carriage or disembarkation of its passengers; or

- (ii) any other act or omission of any person on board that ship; or
- (d) where any loss or damage is caused to any property other than property described in paragraph (b) or any rights are infringed through—
  - (i) the act or omission of any person, whether on board that ship or not, in the navigation or management of the ship, in the loading, carriage or discharge of its cargo or in the embarkation, carriage or disembarkation of its passengers; or
  - (ii) any other act or omission of any person on board that ship,

such owner shall not be liable for damage beyond the amounts specified in subsection (2).

- (2) The amounts referred to in subsection (1) are—
  - (a) in respect of loss of life or personal injury, either alone or together with any loss or damage to property or any infringement of any rights mentioned in paragraphs (b) and (d) of subsection (1), an aggregate amount equivalent to 210 units of account for each ton of that ship's tonnage; and
  - (b) in respect of any loss or damage to property or any infringement of any rights mentioned in the said paragraphs (b) and (d) of subsection (1), an aggregate amount equivalent to 70 units of account for each ton of that ship's tonnage.

(3) The limits on the liability of an owner of a ship set by this section shall apply in respect of each distinct occasion on which any of the events mentioned in paragraphs (a) to (d) of subsection (1) occur without that owner's actual fault or privity and without regard to any liability incurred by that owner in respect of that ship on any other occasion.

(4) This section shall not apply to limit the liability of an owner of a ship in respect of any loss of life or personal injury caused to or any loss of or damage to property or any infringement

of any right of a person who is employed on board or in connection with a ship under a contract of service if that contract is governed by the law of any State other than Trinidad and Tobago and that law does not set any limit to that liability or sets a limit exceeding that set by this section.

Power of the Court to consolidate claims.

**360.** Where any liability alleged to have been incurred by the owner of a ship in respect of any occurrence is limited by section 359 and several claims are made or anticipated in respect of that liability, the Court may, on the application of that owner, determine the amount of his liability and distribute that amount rateably among the several claimants; and in addition the Court may stay any proceedings pending in any other Court in relation to the same matter and may as it thinks just proceed in such manner and subject to Rules of Court—

- (a) enabling interested persons to become parties to the proceedings;
- (b) excluding any claimants who do not apply to be joined in the proceedings within a certain time;
- (c) requiring security from the owner; and
- (d) requiring the payment of any costs.

Extension of limitation or liability.

**361.** (1) The persons whose liability in connection with a ship is limited by section 359 shall include any charterer and any person interested in, or in possession of the ship, in particular, any manager or operator of the ship.

(2) In relation to a claim arising from the act or omission of any person in his capacity as master or member of the crew or, otherwise than in that capacity, in the course of his employment as a servant of the owners or of any person mentioned in subsection (1)—

- (a) the persons whose liability is limited by section 359 shall also include the master, a member of the crew or a servant, and, in a case where the master or member of the crew is the servant of a person whose liability would not be limited otherwise than by virtue of this paragraph, the person whose servant he is; and

- (b) the liability of the master, member of the crew or servant himself is limited to the like extent notwithstanding his actual fault or privity in that capacity.

**362.** (1) Where, without the actual fault or privity of the owners of any dock or canal or any harbour or port authority, any loss or damage is caused to any vessel or vessels or to any goods, merchandise or other things whatsoever on board any vessel or vessels, such owners shall not be liable to damage beyond any aggregate amount equivalent to 70 units of account for each ton of the tonnage of the largest Trinidad and Tobago ship that, at the time of such loss or damage occurring, is or within a period of five years previous thereto has been within the area over which such dock or canal owner or port or harbour authority performs any duty or exercises any power.

Limitation of liability of port authorities and owners of docks.

(2) For the purpose of this section, a ship shall not be deemed to have been within the area over which a port or harbour authority performs any duty or exercises any power by reason only that it has been built or fitted out within such area or that it has taken shelter within or passed through such area on a voyage between two places both situated outside that area or that it has loaded or unloaded mail or passengers within that area.

(3) The limitation of liability under this section shall relate to the whole of any loss and damage which may arise upon any one distinct occasion, although such loss or damage may be sustained by more than one person, and shall apply whether the liability arises at common law or under any written law, and notwithstanding anything contained in any written law.

(4) For the purposes of this section, the expression “owner of a dock or canal” includes any person or authority having the control and management of any dock or canal and any ship repairer using the same, as the case may be.

(5) Nothing in this section shall impose any liability in respect of any loss or damage on any such owners or authority in any case where no such liability would have existed if this Act had not been enacted.

Ships less than 300 tons.

**363.** For the purposes of sections 359 and 360, the tonnage of any ship that is less than three hundred tons shall be deemed to be three hundred tons.

Calculation of tonnage.

**364.** (1) For the purposes of this Part the tonnage of a ship shall be its gross tonnage.

(2) The measurement of such tonnage in the case of a foreign ship shall be according to section 24.

(3) In the case of any foreign ship which is incapable of being measured under the provisions of this Act, the Minister shall, on receiving from or by direction of the Court hearing a case in which the tonnage of the ship is in question, such evidence concerning the dimensions of the ship as it is found practicable to furnish, give a certificate under his hand stating what would in his opinion have been the tonnage of such ship if it had been duly measured according to the provisions of this Act and the tonnage so stated in such certificate shall for the purposes of this Part be deemed to be the tonnage of the ship.

Release of ship on security.

**365.** (1) Where a ship or other property is arrested in connection with a claim which appears to the High Court to be founded on a liability to which a limit is set by section 359 or security is given to prevent an arrest or obtain release from such an arrest, the High Court may, and in the circumstances mentioned in subsection (4) shall, order the release of the ship, property or security if the conditions specified in subsection (3) are satisfied.

(2) Where such release is ordered, the person on whose application it is ordered shall be deemed to have submitted to the jurisdiction of the High Court.

(3) The conditions referred to in subsection (1) are—

(a) that security, which in the opinion of the Court is satisfactory (in this section referred to as “the guarantee”), has previously been given whether in Trinidad and Tobago or elsewhere in respect of the said liability or any other liability incurred on the same occasion and the High Court is

satisfied that if the claim is established the amount for which the guarantee was given or such part thereof as corresponds to the claim would be actually available to the claimant; and

- (b) that either the guarantee is for an amount not less than the said limit, or further security is given which together with the guarantee is for an amount not less than that limit.

(4) The circumstances mentioned in subsection (1) shall be that the guarantee was given in a port which, in relation to the claim, is the relevant port.

(5) For the purposes of this section—

- (a) a guarantee given in more than one State shall be deemed to have been given in the State in which it was last given;
- (b) any question as to whether the amount of any guarantee is, either by itself or together with any other amount, not less than any limit set under the provisions of this Part shall be decided as at the time when the guarantee is given;
- (c) where only part of the amount for which a guarantee was given will be available to a claimant, that part shall not be taken to correspond to his claim if any other part might be available to a claimant, in respect of a liability to which no limit is set as mentioned in subsection (1).

(6) In this section “relevant port” means—

- (a) in relation to any claim, the port where the event giving rise to the claim occurred, or if that event did not occur in a port, the first port of call after the event occurred; and
- (b) in relation to a claim for loss of life or personal injury or damage to cargo, the port of disembarkation or discharge.

**366.** (1) Where by the fault of two or more ships, damage or loss is caused to one or more of those ships, to their cargoes or

Rules as to  
division of  
liability.

freight, or to any property on board, the liability to make good the damage or loss shall be in proportion to the degree in which each ship was at fault.

(2) Where having regard to all the circumstances of the case it is not possible to establish different degrees of fault, the liability shall be apportioned equally.

(3) Nothing in this section shall operate so as to render any ship liable for any loss or damage to which its fault has not contributed.

(4) Nothing in this section shall affect the liability of any person under a contract of carriage or any contract, or shall be construed as imposing any liability upon any person from which he is exempted by any contract or any law or as affecting the right of any person to limit his liability in the manner provided by law.

(5) For the purpose of this section the expression “freight” includes passage money and hire, and reference to damage or loss caused by the fault of a ship shall be construed as including references to any salvage or other expenses consequent upon that fault recoverable at law by way of damages.

Joint and several liability.

**367.** (1) Where loss of life or personal injuries are suffered by any person on board a ship owing to the fault of that ship and of any other ship or ships, the liability of the owners of the ships shall be joint and several.

(2) Nothing in this section shall be construed as depriving any person of any right of defence on which independently of this section he might have relied in any action brought against him by the person injured or any person or persons entitled to sue in respect of such loss of life or shall affect the right of any person to limit his liability in cases to which this action relates in the manner provided by law.

Right of contribution.

**368.** (1) Where loss of life or personal injuries are suffered by any person on board a ship owing to the fault of that ship and any other ship or ships, and a proportion of the damage is recovered against the owners of one of the ships that exceeds the

proportion in which it was at fault, they may recover by way of contribution the amount of the excess from the owners of the other ship or ships to the extent to which these ships were respectively at fault; but no amount shall be so recovered that could not by reason of any statutory or contractual limitation of or exemption from liability, or could not for any other reason have been recovered in the first instance as damages by the persons entitled to sue therefor.

(2) In addition to any other remedy provided by law, the persons entitled to any such contribution as aforesaid shall have, for the purpose of recovering the same, subject to the provisions of this Act, the same rights and powers as the persons entitled to sue for damages in the first instance.

**369.** Sections 366 to 368 inclusive apply to—

- (a) owners;
- (b) persons who, though not actual owners, are responsible for the fault of the vessel;
- (c) persons responsible for the navigation and management of a vessel pursuant to a demise charter.

Extended meaning of owners.

#### PART XIX INQUIRIES

**370.** (1) Where any of the following casualties occur, that is to say:

- (a) the loss or presumed loss, stranding, grounding, abandonment of, or damage to, a ship;
- (b) a loss of life caused by fire on board, or by any accident to, a ship or ship's boat, or by any accident occurring on board a ship or ship's boat; or
- (c) any damage caused by a ship,

Investigations of shipping casualties.

and, at the time it occurs, the ship was a Trinidad and Tobago ship or the ship or ship's boat was in the waters of Trinidad and Tobago, the Minister may cause a preliminary inquiry into the casualty to be held by a person appointed for the purpose by the Minister.

(2) Whether or not a preliminary inquiry into the casualty has been held under subsection (1), the Minister may cause a formal investigation to be held by a Wreck Commissioner appointed under section 372.

Preliminary inquiry.

**371.** (1) For the purposes of a preliminary inquiry under section 370, the person holding the inquiry has all the following powers, namely:

- (a) he may go on board any ship and may inspect the same or any part thereof, or any of the machinery, boats, equipment or articles on board thereof to which this Act applies, not unnecessarily detaining or delaying it from proceeding on any voyage;
- (b) he may enter and inspect any premises the entry or inspection of which, appears to him to be requisite for the purpose of the report which he is directed to make;
- (c) he may, by summons under his hand, require the attendance of all such persons as he thinks fit to make;
- (d) he may require and enforce the production of all books, papers or documents which he considers important for such purpose;
- (e) he may administer oaths, or may, in lieu of requiring or administering an oath, require every person examined by him to make and subscribe a declaration of the truth of the statements made by him in his examination.

(2) Upon conclusion of a preliminary inquiry, the person holding it shall send to the Minister a report containing a full statement of the case and of that person's opinion thereon accompanied by such report of, or extracts from, the evidence, and such observations, as he thinks fit.

Formal investigation.

**372.** (1) The Minister may appoint—

- (a) a person appearing to him to be suitably qualified, by the holding of, or by having held, judicial office, or by experience as a legal practitioner;

- (b) a senior public officer; or
- (c) a senior officer of the Defence Force, to be a wreck commissioner to hold one or more formal investigations.

(2) The Wreck Commissioner holding a formal investigation—

- (a) shall conduct it with the assistance of one or more assessors with nautical, engineering or other special skills or knowledge; and
- (b) shall conduct it in accordance with any Regulations made under section 406.

(3) Notwithstanding subsection (1), where any question concerning the cancellation or suspension of an officer's certificate or licence is likely to arise there shall be at least two assessors with appropriate qualifications and experience in the merchant shipping service assisting the Wreck Commissioner.

(4) Sections 8, 9, 10, 11, 12(2) and 12(3) of the Commissions of Enquiry Act apply to a formal investigation as if the investigation were an inquiry under this Act in relation to which the Wreck Commissioner were the Chairman. Ch. 19:01.

(5) The Wreck Commissioner may make such order with regard to the costs of a formal investigation as he thinks just; and any such costs may be recovered by the Minister from the person ordered to pay them.

(6) At the conclusion of a formal investigation the Wreck Commissioner shall send to the Minister a full report on the investigation, together with the evidence taken.

**373.** Every witness summoned to give evidence in a preliminary inquiry under section 371 or a formal investigation under section 372 shall be allowed such expenses as would be allowed to any witness attending on subpoena to give evidence before any Court of Record; and in case of any dispute as to the amount of such expenses, the same shall be referred by the person presiding over the preliminary inquiry or the formal investigation, Expenses of witnesses.

as the case may be, to the Registrar of the Supreme Court or a Master of the High Court, who, on a request made of him for that purpose under the hand of the said person presiding over the preliminary inquiry or the formal investigation, as the case may be, shall ascertain and certify the proper amount of such expenses.

Effect on  
certificates or  
licences.

**374.** (1) When, as a result of a formal investigation, the Wreck Commissioner—

- (a) is satisfied that any master, mate or engineer—
  - (i) is unfit to discharge his duties whether by reason of incompetence or misconduct or for any other reason;
  - (ii) has been seriously negligent in the discharge of his duties; or
  - (iii) has failed to give any assistance or information required by section 207; and
- (b) in a case coming under paragraph (a)(i) or (ii), is further satisfied that that circumstance caused or contributed to a casualty,

the Wreck Commissioner may cancel or suspend any certificate or licence issued under section 87 or section 89 to the officer concerned or censure him.

(2) Where a certificate or licence is cancelled or suspended pursuant to subsection (1), the officer concerned shall forthwith deliver such certificate or licence to the Wreck Commissioner or the Director.

(3) Notwithstanding subsection (1), a Wreck Commissioner may not cancel or suspend a certificate or licence unless at least one-half of the number of assessors concur, and each assessor who does not concur shall state in writing his dissent and his reasons therefor.

(4) A copy of the report made to the Minister under subsection (6) of section 372 shall be furnished by the Wreck Commissioner to any officer whose certificate or licence is cancelled or suspended, or who is censured.

**375.** (1) Where it appears to the Minister that any master, mate or engineer who holds a certificate or licence under section 87 or section 89— Inquiry into fitness or conduct.

- (a) is unfit to discharge his duties, whether by reason of incompetence or misconduct or for any other reason;
- (b) has been seriously negligent in the discharge of his duties; or
- (c) has failed to give any assistance or information required by section 207 or 213, or contravened section 214,

the Minister may cause an inquiry to be held by any person qualified under section 372 to be appointed as a Wreck Commissioner and, where the Minister does so, he may, where he thinks fit, suspend the certificate or licence pending the outcome of the inquiry and require the officer concerned to deliver it to the Director.

(2) Section 372 applies to an inquiry under this section as if the inquiry were a formal investigation and as if the person holding the inquiry were a Wreck Commissioner.

(3) A person holding an inquiry under this section may, where satisfied of any of the matters mentioned in paragraphs (a) to (c) of subsection (1), censure the officer or, where at least one-half of the number of assessors concur therein, cancel or suspend any certificate or licence issued to the officer under section 87 or section 89.

(4) When a certificate or licence is suspended under this section, the officer concerned shall, unless he has delivered it to the Director under subsection (1), deliver it forthwith to the person holding the inquiry or to the Director.

(5) A copy of the report made to the Minister under section 372(6) shall be furnished by the person holding the inquiry to the master, mate or engineer whose fitness or conduct is inquired into.

**376.** (1) Where an inquiry or formal investigation has been held under this Part, the Minister may, in his discretion order the whole or any part of the case to be reheard. Rehearing and appeal.

(2) It is the duty of the Minister to order a case or part thereof to be reheard—

- (a) where new and important evidence that could not be produced at the inquiry or investigation has been discovered; or
- (b) where it appears to the Minister that there are other grounds for suspecting that a miscarriage of justice might have occurred.

(3) A rehearing under this section—

- (a) may be held by the person or wreck commissioner who held the first inquiry or formal investigation, or by another person qualified to hold the inquiry or investigation, as the Minister may direct;
- (b) shall be conducted in accordance with Regulations made under section 406,

and subject to such Regulations, the provisions of this Part that applied to the original inquiry or investigation under section 370 apply to the rehearing.

Appeals to High Court.

**377.** Where, as a result of a formal investigation under section 372 or an inquiry under section 373—

- (a) the certificate or licence of any person has been cancelled or suspended, or
- (b) any person has been found to be at fault,

then, where no order is made under subsection (1) or (2) of section 389 a person described in paragraph (a) or (b) of this section or any other person who, having an interest in the investigation or inquiry, has appeared at the hearing thereof and is affected by the decision of finding, may appeal to the High Court.

Delivery of certificates, etc.

**378.** (1) A person who fails to deliver a certificate or licence as required by or under sections 374 and 375 is guilty of an offence and is liable to a fine of one thousand dollars.

(2) Where a certificate or licence is delivered to any person other than the Director in pursuance of section 374 or 375 that person shall, as soon as possible, forward it to the Director for retention.

(3) Where a certificate or licence issued under section 89(2) is suspended or cancelled under this Part, the Director shall send a copy of the report on the case and of the evidence to the Government of the State by which the certificate of the officer concerned was issued.

**379.** (1) Where a certificate or licence has been suspended or cancelled under section 374 or 375, the Minister may, where he is of the opinion that the justice of the case so requires—

Power of Minister.

- (a) reissue the certificate or licence or, as the case may be, reduce the period of suspension; or
- (b) grant a new certificate or licence of the same or a lower grade in place of that cancelled or suspended.

## PART XX

### JURISDICTION

**380.** (1) For the purpose of conferring jurisdiction under this Act, every offence shall be deemed to have been committed and every cause of complaint to have arisen, either in the place where the same was actually committed or arose, or in any place where the offender or person complained against may be.

Jurisdiction.

(2) Where, in any proceedings under this Act, a question arises as to whether or not any ship or person is governed by this Act, such ship or person shall be deemed to be governed by this Act unless the contrary is proved.

**381.** (1) A Court which has jurisdiction in any part of the coast of Trinidad and Tobago shall have jurisdiction over any ship lying or passing off that coast, or being in any bay, channel, lake, river or other navigable water near such coast and over all persons on board that ship or for the time being belonging thereto, in the same manner as if the ship or persons were within the limits of the original jurisdiction; save that such jurisdiction shall only be exercised in conformity with any International Convention to which for the time being Trinidad and Tobago is a party.

Jurisdiction over ship lying or passing off the coast.

(2) The jurisdiction conferred by subsection (1) shall be in addition to and not in derogation of any jurisdiction or power conferred by any other law.

Jurisdiction as to offences on board ships.

**382.** Notwithstanding anything contained in any other law, where any person on board any Trinidad and Tobago ship does any act or makes any omission which would be an offence if done or made in Trinidad and Tobago, that person is, regardless of the position of the ship at the time of the act or omission, guilty of that offence and may be tried by any Court having jurisdiction in Trinidad and Tobago.

Jurisdiction in collision and other cases.

**383.** (1) No Court in Trinidad and Tobago shall entertain an action *in personam* to enforce a claim to which this section applies unless—

- (a) the defendant has his habitual residence or a place of business within Trinidad and Tobago;
- (b) the cause of action arose within the waters of Trinidad and Tobago or within the limits of a harbour or port of Trinidad and Tobago; or
- (c) an action arising out of the same incident or series of incidents is proceeding in the Court, or has been heard and determined in the Court.

(2) In this section—

Ch. 50:06.

“harbour” means a harbour established under the Harbours Act; “port” means a statutory port of Trinidad and Tobago and includes any navigable channel leading into such port so declared by the Minister to be an approach thereto.

(3) No Court in Trinidad and Tobago shall entertain an action *in personam* to enforce a claim to which this section applies until any proceedings previously brought by the plaintiff in any Court outside Trinidad and Tobago against the same defendant in respect of the same incident or series of incidents have been discontinued or otherwise come to an end.

(4) Subsections (1) to (3) inclusive shall apply to counterclaims, not being counterclaims in proceedings arising out of the same incident or series of incidents, as they apply to actions *in personam*, and a reference to the plaintiff is a reference to the plaintiff on the counterclaim and a reference to the defendant is a reference to the defendant to the counterclaim.

(5) Subsections (1) to (4) inclusive shall not apply to any action or counterclaim if the defendant thereto submits or has agreed to submit to the jurisdiction of the Court.

(6) Subject to subsection (3) where a Court has jurisdiction for the purposes of this Act, the jurisdiction shall extend to entertain an action *in personam* to enforce a claim to which this section applies whenever any of the conditions specified in subsection (1) is satisfied; and the Rules of Court relating to the service of process outside the jurisdiction shall make such provision as may appear to the Rules Committee established under the Supreme Court of Judicature Act to be appropriate having regard to the provisions of this subsection. Ch. 4:01.

(7) Nothing in this section shall—

- (a) prevent an action or counterclaim which is brought under this section from being transferred to some other Court of competent jurisdiction; or
- (b) affect proceedings in respect of any cause of action arising before the coming into operation of this section.

(8) The claims to which this section applies are claims for damage, loss of life or personal injury arising out of a collision between ships, or out of the carrying out of or omission to carry out a manoeuvre or out of non-compliance with the Collision Rules.

(9) For the avoidance of doubt, it is hereby declared that this section shall apply in relation to the jurisdiction of any Court not being admiralty jurisdiction, as well as in relation to its admiralty jurisdiction, if any.

**384.** In any case in which an action may be brought *in rem* Actions in rem. against any ship (other than actions arising from claims to the possession or ownership of a ship or to the ownership of any share therein, or any claim in respect of a mortgage or charge on a ship or any share therein), where the person who would be liable on the claim in an action *in personam* was, when the cause of action

arose, the owner or charterer of, or in possession or in control of the ship, the admiralty jurisdiction of the High Court may (whether the claim gives rise to a maritime lien on the ship or not) be invoked by an action *in rem* against—

- (a) that ship, if at the time when the action is brought it is beneficially owned as respects all the shares therein by that person; or
- (b) any other ship which, at the time when the action is brought, is beneficially owned as aforesaid,

but in determining whether a person would be liable on a claim in an action *in personam* it shall be assumed that he has his habitual residence or a place of business within Trinidad and Tobago.

Jurisdiction as to unsatisfied mortgages.

**385.** Where the registration of a ship is considered to be closed on account of a transfer to persons not qualified to own a Trinidad and Tobago ship, any unsatisfied mortgage may, where the ship comes within the jurisdiction of any Court in Trinidad and Tobago which has such jurisdiction to enforce the mortgage, or would have had such jurisdiction if the transfer had not been made, be enforced by that Court notwithstanding the transfer, without prejudice, in cases where the ship has been sold under a judgment of a Court to the effect of that judgment.

#### PART XXI

### DETENTION OF AND DISTRESS ON SHIP FOR DAMAGE CAUSED

Inquiry into death on board.

**386.** (1) Where a death occurs on board a Trinidad and Tobago ship, the master shall report the death to the authorities at the first port of arrival and shall submit to the Minister a statement and log extract signed by the master.

(2) Where the Minister decides to hold an investigation into the cause of death, the Director or any person appointed by the Minister for that purpose shall, on the arrival of the ship at a port, inquire into the cause of the death and enter an endorsement in the official logbook either to the effect that the statement of the cause of the death in the official logbook is in his opinion true, or to the contrary effect, according to the results of the inquiry.

(3) The Director or person appointed under subsection (1) has, for the purpose of the inquiry, all the powers of a person making a preliminary inquiry under section 371.

(4) Where in the course of the inquiry it appears to the Director or person holding the inquiry that the death was caused on board the ship by violence or unlawful means, he shall report the matter to the Minister and, where the urgency of the situation so requires, take immediate steps for bringing the offenders to justice.

**\*387.** (1) The Minister may at such places as he considers advisable appoint fit and proper persons to be detaining officers for the better execution of the provisions of this Act that provide for the detention of ships under this Act. Detention of ship.

(2) Where a ship is to be or may be detained under this Act, a detaining officer may detain the ship and if the ship, after being detained or after service on the master of a notice or order for detention proceeds to sea before it is released by a competent authority, the master of the ship and the owner and any person who sends the ship to sea are guilty of an offence unless the accused proves that the ship proceeded to sea without his consent and without any negligence on his part.

(3) Where a ship so proceeding to sea takes any detaining officer to sea when he is aboard the ship in the course of his duty, the owner and master of the ship are liable to pay all the expenses of, and incidental to the detaining officer being so taken to sea and are further liable to a fine of one thousand dollars, and one hundred dollars for every day until the officer returns, or until such time as would enable him after leaving the ship to return to the port from which he is taken, whichever is the greater; and the expenses ordered to be paid may be recovered in like manner as the fine.

(4) Where a ship is to be detained under this Act a Customs officer shall not clear that ship outwards, and where under this Act a ship may be detained, a Customs officer may refuse to clear that ship outwards.

---

\* With respect to section 387(2) to (4), *see* regulation 10 of the Shipping (Provisions and Water) Regulations, 1993 (LN 144/1993) contained in this Chapter.

(5) Where a foreign ship is detained under this Act a copy of the notice or order for detention shall be served on the consular officer of the State to which the ship belongs if one is present at the port of detention.

(6) A person who is guilty of an offence under subsection (2) is liable to a fine of ten thousand dollars.

Seizure and sale.

**388.** (1) Where the owner of a ship has been convicted of an offence under this Act and a fine has been imposed, if the fine is not paid forthwith, the ship may be seized and after reasonable notice, sold by any Customs officer or any person authorised for that purpose in writing by the Minister, and such officer or person may, by bill of sale, give to the purchaser a valid title to the ship, free from any mortgage or other claim thereon which at the time of the sale may be in existence.

(2) Any surplus money remaining from the proceeds of sale after paying the amounts of fines payable under section 387 together with the costs of the seizure and sale shall be disposed of in accordance with rules of Admiralty Law.

Distress on ship.

**389.** Where any Court has power to make an order under this Act directing payment to be made of any seaman's wages, fines or other sums of money, then, if the party so directed to pay the same is the owner or master of a ship, and the same is not paid at the time or in the manner prescribed in the order, the Court which made the order may, in addition to any other powers it may have for the purpose of compelling payment, direct the amount remaining unpaid to be levied by distress and sale of the ship, the tackle, furniture and apparel.

## PART XXII

### COURT OF SURVEY

Constitution of Court of Survey.

**390.** (1) A Court of Survey for a port shall consist of a Judge of the High Court nominated for the matter by the Chief Justice, sitting with two assessors.

(2) The assessors shall be persons of nautical, engineering or other special skill and experience, one of whom shall be appointed by the Minister or, in the case of a foreign ship by the consular officer at or near the port, and the other shall be appointed by the Judge of the Court.

**391.** (1) The Court of Survey shall have the power and the duty to entertain such matters as are referred to it under section 257. Jurisdiction of Court of Survey.

(2) The following provisions shall have effect in relation to a Court of Survey concerning any ship:

- (a) the matter shall be heard in open Court;
- (b) the Judge, each assessor, and any person appointed by the Judge may survey the ship and may go on board the ship and inspect the ship and every part thereof and the machinery, equipment and cargo, and may require the unloading and removal of any cargo, ballast or tackle, and shall for such purposes have all the powers of a surveyor under this Act;
- (c) the Court may order the ship to be surveyed and may appoint any competent person or persons to survey the ship and report thereon to the Court;
- (d) the Judge shall have the same power as the Director to order the ship to be released; and
- (e) the owner and the master of the ship, and any person appointed by the owner or master, may attend any inspection or survey made under this section.

(3) The Court may make such orders with respect to the costs of any inquiry or investigation under this Act and the recovery thereof as it may think fit.

(4) The Judge of the Court shall sign and transmit to the Minister a report of the matter; and each assessor shall either sign the report or transmit a separate report signed by him to the Minister setting out the reasons for his dissent.

(5) Any person who wilfully impedes the Judge of the Court of Survey, or any assessor or other person, in the execution of any survey under this section, or fails to comply with any order made by him is guilty of an offence and is liable to a fine of five thousand dollars.

Expert witnesses.

**392.** The Judge of the Court may at any time during a hearing permit or summon an expert witness to give an expert opinion based on his special knowledge, skill, experience or training in respect of construction or design or of a scientific difficulty or important principle.

Power to make Rules.  
Ch. 4:01.

**393.** The Rules Committee established by the Supreme Court of Judicature Act may make Rules to carry into effect the provisions of this Act with respect to a Court of Survey and, without prejudice to the generality of the foregoing, those Rules shall, in particular, make provision for—

- (a) conferring a right of appeal against decisions of the Court of Survey and for security for costs;
- (b) the remuneration of officers of the Court in respect of matters within the jurisdiction of the Court and the fees to be charged.

#### PART XXIII

#### LEGAL PROCEEDINGS

Prosecution of offences and penalties.  
Ch. 4:20.

**394.** (1) Except as otherwise expressly provided, in this Act proceedings in respect of offences under this Act shall be prosecuted under the Summary Courts Act.

(2) A person who commits an offence under this Act, for which no specific penalty is provided, is liable to a fine of one thousand dollars and to imprisonment for six months.

(3) Where an offence under this Act is a continuing one, and no penalty is provided in respect of the continuance thereof elsewhere than in this section, every person who commits that offence, in addition to any other liability, is liable to a fine of one hundred dollars for every day or part thereof during which the offence continues.

Limitation of time as to summary proceedings.

**395.** (1) Neither a conviction for an offence nor an order for payment of money shall be made under this Act in any summary proceedings instituted in any Magistrate's Court—

- (a) unless such proceedings are commenced within six months after the commission of the offence or after the cause of the complaint arises, as the case may be; or

- (b) where both, or either of, the parties to the proceedings happen or happens during that time to be out of Trinidad and Tobago, unless the proceedings are commenced, in the case of—
- (i) a conviction, within two months; and
  - (ii) an order, within two months after they both first happen to arrive, or to be at one time, in Trinidad and Tobago.

(2) No other written law for the time being in force which limits the time within which proceedings may be instituted in any Magistrate's Court shall affect any proceedings under this Act.

**396.** (1) Notwithstanding any other provisions of this Act, the Director may compound any offence under this Act, by accepting from the person reasonably suspected of having committed such offences, a fine not exceeding twenty thousand dollars.

Compounding of offences.

(2) On payment of any sum of money under subsection (1)—

- (a) the person reasonably suspected of having committed the offence in respect of which the payment has been made shall, if in custody, be discharged;
- (b) any ship detained in respect of such offence shall be released; and
- (c) no further proceedings shall be taken against such person or ship in respect of such offence.

**397.** (1) Subject to this section, no action shall be maintainable to enforce any claim or lien against a ship or its owners in respect of any damage or loss to another ship, its cargo or freight, or to any property on board, or in respect of damages for loss of life or personal injuries suffered by any person on board the ship, caused by the fault of the first-mentioned ship, irrespective of whether such ship be wholly or partly in fault, or in respect of any salvage services, unless proceedings therein are commenced within two years from the date when the damage or loss or injury was caused or the salvage services were rendered.

Limitation of actions in civil proceedings.

(2) No action shall be maintainable under this Act to enforce any contribution in respect of an overpaid proportion of damages for loss of life or personal injuries, unless the proceedings are commenced within one year from the date of payment.

(3) Any Court of competent jurisdiction, may, in accordance with the Rules of Court, extend any such conditions as the Court thinks fit and if satisfied that during that period there has not been a reasonable opportunity of arresting the defendant ship within the jurisdiction of the Court, or within the territorial sea of the State to which the ship of the plaintiff belongs or in which the plaintiff resides or has his principal place of business, extend the period to the extent necessary to give a reasonable opportunity.

(4) Nothing in this section shall affect any written law relating to compensation for workmen.

Depositions in cases in which witnesses cannot be produced.

**398.** (1) Subject to this section, where in the course of any proceedings instituted under this Act before any Court or person authorised to receive evidence, the testimony of any witness is required in relation to the subject matter of the proceedings, and the witness cannot be found in Trinidad and Tobago, any deposition that the witness has previously made on oath in relation to the same subject matter before any Court or consular officer elsewhere shall be admissible in evidence.

(2) No deposition shall be admissible in criminal proceedings unless the deposition was taken in the presence of the person accused or his legal adviser and is authenticated by the seal of the Court or the signature of the consular officer before whom it was made, and the Court or consular officer shall certify, if it is so, that the accused or his legal adviser was present when the deposition was taken.

(3) A deposition admissible for the purposes of this section shall be deemed to be duly authenticated by the seal of the Court or the signature of the consular officer before whom it was made, and the Court or consular officer shall certify, if it is so, that the accused or his legal adviser was present when the deposition was taken.

(4) It shall not be necessary in any case to prove the seal or official signature or official character of the person appearing to have signed any such deposition; and in criminal proceedings, a certificate purporting to have been signed by the Judge, Magistrate or consular officer before whom the deposition was taken shall, unless the contrary is proved, be sufficient evidence of the fact that the accused or his legal adviser was present in the matter certified.

(5) Nothing in this section shall affect any case in which depositions taken in any proceedings are rendered admissible in evidence by any other written law.

**399.** Notwithstanding anything in any other written law, where any document is required by this Act to be executed in the presence of, or to be attested by, any witnesses, that document may be proved by the evidence of any person who is able to bear witness to the requisite facts, without calling any of the attesting witnesses.

Evidence and service of documents.

**400.** (1) Where a document is under this Act declared to be admissible in evidence, the document shall, on its production from the proper custody, be admissible in evidence in any Court or before any person having proper authority to receive evidence, and, unless admission is refused on any other ground, shall be evidence of the matters stated therein under this Act or by any officer in pursuance of his duties as such officer.

Admissibility of documents in evidence.

(2) A copy of any such document or extract therefrom shall also be admissible in evidence if it is proved to be a copy or extract made from or compared with the original, or if it purports to be signed and certified as a true copy or extract by the officer to whose custody the original document was entrusted and that officer shall furnish such certified copy or extract to any person applying for it at a reasonable time upon payment of the prescribed fee for the same.

(3) If any such officer wilfully certifies any document as being a true copy or extract knowing the same not to be a true copy or extract, he is guilty of an offence.

(4) A person who, knowing the same to be false or counterfeit—

- (a) forges the seal, stamp or signature on any document referred to in this section; or
- (b) tenders in evidence any such document with a false or counterfeit seal, stamp or signature thereto,

is guilty of an offence triable on indictment and is liable to imprisonment for seven years.

(5) Where a document described in subsection (4) has been admitted in evidence, the Court or the person who admitted it may on request direct that it be impounded and kept in the custody of some officer of the Court or other person for such period or subject to such conditions as the Court or person thinks fit.

Service of documents.

**401.** (1) Where, for the purpose of this Act, a document is to be served on any person, that document may be served—

- (a) in any case, by delivering a copy thereof personally to the person on whom the document is to be served, or by leaving the same at his last known place of abode;
- (b) where the document is to be served on the master, if any, of a ship, or on a person belonging to a ship, by leaving the same for him on board the ship with the person being, or appearing to be, in command or charge of the ship;
- (c) where the document is to be served on the master of a ship, or where there is no master, and the ship is within Trinidad and Tobago, on the managing owner of the ship, or where there is no managing owner, on some agent of the owner residing in Trinidad and Tobago, or where no such agent is known or can be found, by affixing a copy thereof in some conspicuous place on board the ship where it may be seen by persons who enter the ship.

(2) Where any person obstructs the service on the master of a ship of any document under the provisions of this Act that person is guilty of an offence and is liable to a fine of five hundred dollars and, if the owner or master of the ship is party or privy to the obstruction, he is also guilty of an offence and is liable to a fine of one thousand dollars.

**PART XXIV**

**ADMINISTRATION OF THE ACT**

**402.** The Minister in addition to any other power conferred on him by any other provisions of this Act shall be responsible for the administration and implementation of this Act.

Power of the Minister to administer the Act.

**403.** (1) There shall be established a Division of Maritime Services.

Office of the Director of Maritime Services.

(2) The Division of Maritime Services shall include the following public offices the holders of which shall be marine officers:

- (a) Director of Maritime Services, who shall exercise general supervision over all matters to which this Act relates;
- (b) Registrar of Ships;
- (c) Registrar of Seamen;
- (d) Surveyors; and
- (e) Principal Receiver of Wreck.

(3) The Director may be the Principal Receiver of Wreck.

(4) Any act done by, or to or before any officer in the Director's office in pursuance of any powers conferred upon or delegated to him by the Director shall have the same effect as if done by, to, or before, the Director, as the case may be.

**404.** (1) The Minister may, by Notice, delegate to the Director or any other officer or officers of the Division of Maritime Services or any person appointed, nominated or authorised to perform any functions under this Act, any of his powers or duties and any power or duty lawfully exercised or

Delegation of powers.

performed by the officer to whom it has been delegated under this subsection, shall be deemed to have been exercised as fully and effectively as if it had been exercised by the Minister.

(2) Nothing in this section shall be construed as authorising the delegation of any power to make any order or Regulation for the purposes of this Act.

Protection of  
public officers.

**405.** No suit shall be maintained against any public officer or other person appointed, nominated or authorised to perform any functions under this Act in respect of anything done or omitted to be done by him in good faith in the exercise or performance of any power, authority or duty conferred or imposed on him under this Act.

Power of  
Minister to  
make  
Regulations.

**406.** The Minister may make Regulations generally for the administration of this Act, and in particular, for the following purposes:

- (a) the enforcement of any international convention relating to this Act and all maritime matters;
- (b) the carriage of passengers and cargo by ship;
- (c) the training and qualification of officers, seamen and fishermen;
- (d) certificates of competency and licences;
- (e) the manning and survey of all ships including fishing vessels;
- (f) the operation of maritime training schools;
- (g) pleasure craft, droghers, lighters and other craft;
- (h) the exemption of vessels from the provisions of this Act;
- (i) the safety of navigation, load lines and the appointment, duties and powers of surveyors of ships;
- (j) licensed Trinidad and Tobago ships;
- (k) ships operating solely within the waters of Trinidad and Tobago;
- (l) fees, stamp duties and all other payments required under this Act;

- (m) the holding of all inquiries and investigations;
- (n) lighthouses, buoys and beacons;
- (o) prescribing sanctions and penalties by way of fines not exceeding one thousand dollars for the contravention of any Regulation;
- (p) the categories and classes of Trinidad and Tobago ships by reference to their tonnage capacity, the nature of their cargo and the trade or voyage in which they are engaged including geographical limits;
- (q) prescribing anything that under this Act is to be prescribed.

**407.** All fees, fines and other sums payable under this Act shall be paid into the Consolidated Fund. Consolidated Fund.

**408.** The Minister may by Order amend the Schedule. Amendment of Schedule.

**409.** (1) Sections 410 and 411 apply in respect of international conventions, including amendments thereto and replacements thereof and other international instruments. Application.

(2) The Minister shall from time to time by Notice publish the international conventions including amendments thereto and replacements thereof and other international instruments which apply to Trinidad and Tobago, the reservations if any, entered thereon by Trinidad and Tobago as well as those international conventions, including amendments thereto and replacements thereof and other international instruments which cease to apply to Trinidad and Tobago.

- (3) The Director shall keep in his office a copy of—
- (a) all the instruments referred to in subsection (2) that have application in Trinidad and Tobago;
  - (b) all Regulations and Notices made pursuant to this Act,

and copies shall be made available for inspection or, upon payment of a prescribed fee, for the taking of copies thereof by members of the public, seafarers or persons concerned with or having an interest in ships or merchant shipping.

Conventions to prevail.

**410.** Where an international convention or other international instrument applies to Trinidad and Tobago and a provision of that convention or instrument and a provision of this Act conflict in any manner, the provision of the convention or instrument shall prevail unless the Minister otherwise provides.

Contravention of international conventions.

**411.** Where, in respect of any Trinidad and Tobago ship, there is any contravention of a requirement of any international convention or other international instrument which applies to Trinidad and Tobago, the Director may suspend the Certificate of Registry of the ship until the contravention is rectified.

#### PART XXV

#### \*FINAL AND TRANSITIONAL PROVISIONS

Exemption of Trinidad and Tobago Government ships from the application of this Act.

**412.** (1) Except as otherwise provided in this Act, nothing in this Act shall apply—

- (a) to Trinidad and Tobago Government ships operated for non-commercial purposes;
- (b) to ships or aircraft of the Defence Force.

(2) The Minister may make Regulations prescribing the manner and extent to which the provisions of this Act apply to Trinidad and Tobago Government ships operated for non-commercial purposes.

Repeal.  
Ch. 50:01.  
Act No. 48 of  
1977.

**413.** (1) The Merchant Shipping Act, 1894 of the United Kingdom as in force on 31st August, 1962, the Merchant Shipping Act and the Pleasure Boats Act shall cease to have effect in their application to Trinidad and Tobago.

(2) Subject to the provisions of this section the jurisdiction vested in the High Court in admiralty matters relating to shipping howsoever derived, and rules of practice relating thereto at the date of the commencement of this Act shall continue in force together with any jurisdiction granted by this Act and all written laws and rules legal and equitable in force before the commencement of this Act shall continue in force except as far as they are inconsistent with the express provisions of this Act.

\*See Note on page 3.

(3) All written laws in force immediately before the commencement of this Act shall, in so far as they are not inconsistent with the provisions of this Act, remain in force as if made under this Act with such adaptations, qualifications and modifications as may be necessary for the purpose.

---

**LAWS OF TRINIDAD AND TOBAGO**

MINISTRY OF THE ATTORNEY GENERAL AND LEGAL AFFAIRS

www.legalaffairs.gov.tt

214

**Chap. 50:10**

*Shipping*

**SCHEDULE**

REPUBLIC OF TRINIDAD AND TOBAGO

Section 52(2).

**FORM A**

**BILL OF SALE**

Official Number	Name of Ship	Number, Date and Port of Registry		
Whether a Sailing, Steam or Motor Ship		Horse Power of Engines		
		Feet	Tenths	Metres
Length from fore part of stem, to the aft side of the head of the stern post... ..				
Main breadth to outside of plating... ..				
Depth in hold from tonnage deck to ceiling amidships ... ..				
<b>NUMBER OF TONS</b>				
Gross ... ..		Net ... ..		

and as described in more detail in the Survey report and the Register Book.  
 (a) ..... the undersigned (b) .....  
 or  
 We (c) ..... having our principal place of business at .....  
 .....  
 in consideration of the sum of ..... paid to (d) .....  
 by (e) ..... the receipt whereof is hereby acknowledged, transfer  
 .....shares in the Ship above particularly described, and  
 in its boats, equipment, and appurtenances, to the said .....

Further (a) ..... the said ..... for (f) .....  
heirs or successors covenant with the said ..... and (g) ..... assigns,  
that (a)..... have power to transfer in manner aforesaid the  
premises hereinbefore expressed to be transferred, and that the same are free  
from incumbrances (h) .....

In witness whereof (a) ..... have hereunto subscribed (i) .....  
..... name .....  
and affixed (i) ..... seal this ..... day of .....  
Two thousand and .....

Executed by the above-named .....

or

the common seal of the .....was affixed hereto in  
the presence of (j)

- (a) Insert as appropriate “I” or “we”.
- (b) Insert full name and address, with the description of the transferor or transferors.
- (c) Here insert title in full of the Company.
- (d) Insert as appropriate “me” or “us”.
- (e) Insert full name and address of transferee or transferees with their description in the case of individuals, and adding “as Joint Owners” where such is the case.
- (f) Insert as appropriate “myself and my” or “ourselves and our”.
- (g) Insert as appropriate “his”, “their”, or “its”.
- (h) If there be any subsisting Mortgage, add “save as appears by the Registry of the said ship”.
- (i) Insert as appropriate “my” or “our”.
- (j) Name, address, and description of witness (two in the case of a Company).

NOTE—A purchaser of a Registered Trinidad and Tobago ship does not obtain a complete title until the Bill of Sale has been recorded at the Port of Registry of the ship, and neglect of this precaution may entail serious consequences.

NOTE—Registered owners or mortgagors are reminded of the importance of keeping the Registrar of Ships informed of any change of residence on their part.

**LAWS OF TRINIDAD AND TOBAGO**

MINISTRY OF THE ATTORNEY GENERAL AND LEGAL AFFAIRS

www.legalaffairs.gov.tt

216

**Chap. 50:10**

*Shipping*

Section 59(1).

**FORM B**

**MORTGAGE (TO SECURE PRINCIPAL SUM AND INTEREST)**

Official Number	Name of Ship	Number, Date and Port of Registry						
Whether a Sailing, Steam or Motor Ship		Horse Power of Engines						
		<table border="1"> <thead> <tr> <th align="center">Feet</th> <th align="center">Tenths</th> <th align="center">Metres</th> </tr> </thead> <tbody> <tr> <td> </td> <td> </td> <td> </td> </tr> </tbody> </table>	Feet	Tenths	Metres			
Feet	Tenths	Metres						
Length from fore part of stem, to the aft side of the head of the stern post ... ..								
Main breadth to outside of plating... ..								
Depth in hold from tonnage deck to ceiling amidships ... ..								

**NUMBER OF TONS**

Gross	... ..	Net	... ..
-------	--------	-----	--------

and as described in more detail in the Certificate of Survey and the Register Book.

UNOFFICIAL VERSION

UPDATED TO 31ST DECEMBER 2016

(a) ..... the undersigned (b) ..... in consideration of  
..... this day lent to (c). ..... by (d) ..... do  
hereby for (e) ..... and (f) .....heirs, covenant with the  
said ..... firstly. That (a) ..... or (f) .....  
heirs, executors or administrators, will pay to the said .....the said  
sum of ..... together with interest thereon at the rate of .....  
per cent per annum on the (g) ..... day of .....next; and  
secondly, that if the said principal sum is not paid on the said day (a) .....  
or (f) .....heirs, executors, or administrators, will, during such time  
at the same or any part thereof remains unpaid, pay to the said .....  
interest on the whole or such part thereof as may for the time being remain  
unpaid, at the rate of ..... per cent per annum, by equal half-yearly payments  
on the ..... day of ..... and .....day of .....  
.....in every year; and for better securing to the said .....  
the repayment in manner aforesaid of the said principal sum and interest  
(a) ..... hereby mortgage to the said ..... shares, of which (h) .....  
the Owner .....in the ship above particularly described, and in its boats,  
equipment and appurtenances. Lastly, (a) ..... for (e) .....  
and (f) ..... heirs, covenant with the said ..... and  
..... assigns that (a) .....have power to mortgage in  
manner aforesaid the above-mentioned shares, and that the same are free from  
incumbrances (i) .....

In witness whereof (a) ..... have hereto subscribed (f) .....  
name ..... and affixed (f) ..... seal ..... this .....  
day of ..... Two thousand and .....

LAWS OF TRINIDAD AND TOBAGO

MINISTRY OF THE ATTORNEY GENERAL AND LEGAL AFFAIRS

www.legalaffairs.gov.tt

218

Chap. 50:10

Shipping

Executed by the above-named .....

.....

.....

in the presence of (j)

.....

.....

(a) "I" or "we" (b) Here insert full name and address with description of the mortgagor or mortgagors, (c) "me" or "us". (d) Here insert full name and address of mortgagee or mortgagees with their description in the case of individuals, and adding "as Joint Mortgagees" where such is the case (e) "myself" or "ourselves" (f) "my" or "our". (g) Insert the day fixed for payment of principal as above. (h) "I am" or "we are". (i) If any prior incumbrance add, "save as appears by the registry of the said ship". (j) Name, address and description of witness.

NOTE—The prompt registration of a Mortgage Deed at the Port of Registry of the ship is essential to the security of the Mortgagee, as a Mortgage takes its priority from the date of production for registry, *not from the date of the instrument.*

NOTE—Registered Owners or Mortgagees are reminded of the importance of keeping the Registrar of Ships informed of any change of residence on their part.

Priced

**FORM C**

Section 59(1).

**MORTGAGE (TO SECURE ACCOUNT CURRENT, ETC.)**

Official Number	Name of Ship	Number, Date and Port of Registry		
Whether a Sailing, Steam or Motor Ship		Horse Power of Engines		
		Feet	Tenths	Metres
Length from fore part of stem, to the aft side of the head of the stern post ... ..				
Main breadth to outside of plating... ..				
Depth in hold from tonnage deck to ceiling amidships ... ..				
NUMBER OF TONS				
Gross ... ..			Net ... ..	

and as described in more detail in the Certificate of Survey and the Register Book.

Whereas (a) .....

.....

.....

.....

Now (b) ..... the undersigned .....

in consideration of the premises for (c) .....and

(d) .....heirs, covenant with the said

..... and (e) .....

assigns, to pay to him or them the sums for the time being due on this security, whether by way of principal or interest, at the times and manner aforesaid. And for the purpose of better securing to the said .....

.....the payment of such sums as last aforesaid,

LAWS OF TRINIDAD AND TOBAGO

MINISTRY OF THE ATTORNEY GENERAL AND LEGAL AFFAIRS

www.legalaffairs.gov.tt

220

Chap. 50:10

Shipping

(b) ..... do hereby mortgage to the said
..... shares, of which (f) .....
the owner .....in the ship above particularly
described, and in its boats, equipment and appurtenances.

Lastly, (b) ..... for (c).....and
(d) ..... heirs, covenant with the said .....
..... and (e) .....
assigns that (b) .....have power to
mortgage in manner aforesaid the above-mentioned shares, and that the same
are free from incumbrances (g) .....

In witness whereof (b) .....have hereto
subscribed (d) ..... name .....
and affixed (d) ..... seal .....this
..... day of ..... Two thousand and .....

Executed by the above-named .....
.....
.....

in the presence of \*
.....
.....

(a) Here state by way of recital that there is an account current between the
Mortgagor (giving his address and description and if Joint Owners are
concerned describing them as such) and the Mortgagee (giving his address and
description. If the Mortgagee is a body corporate the full title and address must
be given and if Joint Mortgagees are concerned they must be so described),
and describe the nature of the transaction so as to show how the amount of
principal and interest due at any given time is to be ascertained and the manner
and time of payment (b) "I" or "we", (c) "myself" or "ourselves", (d) "my" or
"our", (e) "his" or "their", (f) "I am" or "we are", (g) if any prior incumbrance
add, "save as appears by the Registry of the said ship". \*Name, address and
description of witness.

NOTE—The prompt registration of a Mortgage Deed at the Port of Registry of
the ship is essential to the security of the Mortgagee, as a Mortgage takes its priority
from the date of production for registry, not from the date of the instrument.

NOTE—Registered Owners or Mortgagees are reminded of the importance of
keeping the Registrar of Ships informed of any change of residence on their part.

UNOFFICIAL VERSION

UPDATED TO 31ST DECEMBER 2016

FORM D

Section 64(1).

MORTGAGE (TO SECURE ACCOUNT CURRENT, ETC.)  
(INDIVIDUALS OR JOINT OWNERS)

TRANSFER OF MORTGAGE—BY INDIVIDUAL OR JOINT OWNERS

(a) ..... the within-mentioned ..... (a) "I" or "we"  
in consideration of ..... this day paid to (b) ..... (b) "me" or "us"  
..... by .....hereby transfer  
to (c) ..... the benefit of the within-written (c) "him"  
"them" or "it"  
security. In witness whereof (a) .....have hereunto  
subscribed (d) ..... name ..... (d) "my" or  
"our"  
and affixed .....(d) .....  
seal ..... this ..... day of .....Two  
thousand and .....

Executed by the above-named .....

.....  
in the presence of (e)

(e) Name,  
address and  
description of  
witness.

LAWS OF TRINIDAD AND TOBAGO

MINISTRY OF THE ATTORNEY GENERAL AND LEGAL AFFAIRS

www.legalaffairs.gov.tt

222

Chap. 50:10

Shipping

Section 64(1).

FORM E

TRANSFER OF MORTGAGE—BY CORPORATION

The within-mentioned .....
in consideration of .....
this day paid to it by .....

(c) "him" hereby transfer to (c) .....the benefit of the (c)
"them" or "it" within-written security.

In witness whereof we have hereunto affixed our common seal this .....
day of ..... Two thousand and .....

The Common Seal of the .....
.....

was affixed in the presence of\*
.....
.....
.....

\*Signatures and description of witnesses, i.e., Directors, Secretary, etc.

---

**SUBSIDIARY LEGISLATION**

---

**SHIPPING (REGISTRATION OF SHIPS)  
REGULATIONS**

ARRANGEMENT OF REGULATIONS

**REGULATION**

1. Citation.
2. Definitions.
3. Application.

**PART I**

**FIRST REGISTRATION**

4. Application for registration.
5. Declaration of ownership.
6. Survey and measurement.
7. Survey of ships at ports in a foreign State.
8. Name of ship.
9. Official number.
10. Carving and Marking Note.
11. Carving and marking of ships.
12. Port of Registry.
13. Issue of Certificate of Registry.
14. Acquisition of ships in a foreign State and issue of Provisional Certificate of Registry.
15. Temporary pass for unregistered ship.

**PART II**

**CHANGES AND ALTERATIONS**

16. Change of name of ship.
17. Change of name of ship in a foreign State.
18. Registration of alterations.
19. Change of Port of Registry.

**LAWS OF TRINIDAD AND TOBAGO**

MINISTRY OF THE ATTORNEY GENERAL AND LEGAL AFFAIRS

www.legalaffairs.gov.tt

224

**Chap. 50:10**

*Shipping*

[Subsidiary]

*Shipping (Registration of Ships) Regulations*

ARRANGEMENT OF REGULATIONS—*Continued*

REGULATION

**PART III**

**TRANSFER, COMMISSION AND MORTGAGE**

20. Bill of Sale.
21. Recording of sale transaction.
22. Mortgage of ship or share therein.
23. Priority of mortgages.
24. Discharge of mortgage.
25. Registration of mortgages executed and discharged by companies.
26. Endorsement of change of ownership on Certificate of Registry.

**PART IV**

**REGISTRATION OF GOVERNMENT SHIPS AND  
ABANDONED SHIPS**

27. Registration of Government ships.
28. Registration of ships under construction.
29. Registration of abandoned ships.

**PART V**

**MISCELLANEOUS**

30. Delivery up of certificate of ship lost or ceasing to be Trinidad and Tobago owned.
31. Power to grant new Certificate of Registry.
32. Provision for loss of certificate.
33. Change of name of Company.
34. Appointment and change of master.
35. Inspection of the Register, etc.
36. Delivery up of Provisional Certificate of Registry.
37. International Radio call sign.
38. Return and Reports.
39. Forms.
40. Fees.
41. Penalties.

**FIRST SCHEDULE.  
SECOND SCHEDULE.**

---

UNOFFICIAL VERSION

UPDATED TO 31ST DECEMBER 2016

**SHIPPING (REGISTRATION OF SHIPS)  
REGULATIONS**

223/1987.

*made under sections 5, 15, 18, 21, 27, 28, 31, 32, 33 and 406*

**1.** These Regulations may be cited as the Shipping (Registration of Ships) Regulations. Citation.

**2.** In these Regulations, unless the context otherwise requires— Definitions.

“Act” means the Shipping Act;

“Administration” means the Government of the State whose flag the ship is flying;

“certifying authority” means the Minister or any person authorised by the Minister for the purpose of these Regulations and includes in particular (if so authorised) Lloyd’s Register of Shipping, Bureau Veritas, Det Norske Veritas, Germanischer Lloyd, and the American Bureau of Shipping;

“existing ship” means the ship, the construction of which was fully completed before the coming into force of these Regulations;

“first registry” means the registration of a ship coming on the Register Book for the first time;

“government ship” means a ship belonging to the Government of Trinidad and Tobago other than a ship of the Trinidad and Tobago Defence Force;

“international voyage” means a voyage from a port in one State to a port in another State;

“Minister” means the Minister to whom the responsibility for Shipping is assigned;

“port of discharge” means the first port in Trinidad and Tobago at which a ship discharges any part of her cargo;

“proper officer” means proper officer as defined in section 2 of the Act;

“Register Book” or “Register” means a Register Book kept under section 14 of the Act;

“Registrar” means the Registrar of Ships as provided for in sections 6(1) and 403(2)(b) of the Act;

**LAWS OF TRINIDAD AND TOBAGO**

MINISTRY OF THE ATTORNEY GENERAL AND LEGAL AFFAIRS

www.legalaffairs.gov.tt

226

**Chap. 50:10**

*Shipping*

[Subsidiary]

*Shipping (Registration of Ships) Regulations*

“re-registry” means the registry of a ship which has previously been on the Trinidad and Tobago Register, but the registry of which was closed by reason of wreck, abandonment, constructive loss, sale to foreigners or for any other reason;

“surveyor” means a surveyor appointed by a certifying authority.

Application.

**3.** These Regulations apply to—

- (a) any Trinidad and Tobago ship of twenty-four metres or over in length, including Government ships; and
- (b) any Trinidad and Tobago ship which is engaged in international voyages, including Government ships.

**PART I**

**FIRST REGISTRATION**

Application for registration.

**4.** Every application for the registration of a ship under section 7 of the Act shall be accompanied by the following:

- (a) the Declaration of Ownership;
- (b) the Builder’s Certificate, that is to say, a certificate signed by the builder of the ship and containing a true account of the main dimensions and tonnage of the ship as determined by him, the time when and the place where the ship was built and the name of the person, if any, on whose account the ship was built;
- (c) where a ship has been purchased, the Bill of Sale;
- (d) any other proof of ownership required by the Registrar; and
- (e) the prescribed fee.

Declaration of ownership.

**5.** Every declaration of ownership shall be made before the Registrar, a Justice of the Peace, a Commissioner of Affidavits, or a Trinidad and Tobago Consular Officer and where a declaration of ownership is made at a place other than the Port of Registry, the place of attestation shall be stated in the declaration.

UNOFFICIAL VERSION

UPDATED TO 31ST DECEMBER 2016

**6.** After the Registrar has satisfied himself as to the evidence of ownership he shall cause the ship to be surveyed by a surveyor and its tonnage ascertained in accordance with the Shipping (Tonnage) Regulations, and thereafter the surveyor shall submit to the Registrar a Certificate of Survey in respect of the ship.

Survey and measurement.

Sub Leg. 147/1988.

**7.** Where it becomes necessary for a ship to be surveyed at a port in a foreign State, for purposes of registration, the Registrar may depute a surveyor or request the Government of the State where the ship is lying to appoint a qualified surveyor to survey the ship and submit to the Registrar a Certificate of Survey in respect of the ship.

Survey of ships at ports in a foreign State.

**8.** The owner or his agent shall give to the Registrar notice of the name proposed for the ship in prescribed form at least fourteen days before the date on which he desires to effect the registry and upon such name being approved by the Registrar the ship shall be registered under that name.

Name of ship.

**9.** The Registrar shall, upon completion of all requirements for registration, provided in regulations 4, 5, 6, 7 and 8 allot to the ship—

Official number.

- (a) where it is a fishing vessel, an identity mark;
- (b) where it is not a fishing vessel, an official number.

**10.** Where in respect of a ship an identity mark or an official number has been allotted, the Registrar shall issue to the owner a Carving and Marking Note which shall be returned to the Registrar after the carving and marking as indicated in the Note has been carried out in accordance with regulation 11.

Carving and Marking Note.

**11.** (1) Every ship shall, prior to registration, be marked permanently and conspicuously to the satisfaction of the Registrar in the manner provided herein—

Carving and marking of ships.

- (a) in the case of a fishing vessel the identity mark allotted to the ship shall be marked on each of the bows and the intended Port of Registry shall be marked on the stern;

- (b) in the case of any other ship, the name shall be marked on each of the bows and the name and the intended Port of Registry shall be marked on the stern;
- (c) in all cases the marking shall be in white or yellow numerals or letters on a dark background or in black numerals or letters on a light background;
- (d) the numerals or letters shall be not less than one decimetre in height and of proportionate breadth.

(2) The identity mark allotted in the case of a fishing vessel and the official number allotted to any other type of ship, together with, in all cases, the number denoting the ship's net tonnage shall be permanently cut in or welded on the ship's main structure in a conspicuous place as approved by the surveyor.

(3) A scale of decimetres, or of metres and decimetres, denoting a draught of water, shall be marked on each side of the stem and of the stern post—

- (a) in figures at two-decimetre intervals, where the scale is in decimetres; and
- (b) in figures at each metre interval and at intervening two-decimetre intervals, where the scale is in metres and decimetres, the capital letter "M" being placed after each metre figure; the top figure on the scale showing both the metre and, except where it marks a full metre interval, the decimetre figure; the lower edge of the figures, or figures and letters, as the case may be, coinciding with the draught denoted thereby; the figures and letters being not less than one decimetre in height and marked by being cut in or welded and painted white or yellow on a dark background or black on a light background, or in such other way as the Minister may approve.

(4) In the case of an existing ship the draught marks may take the form of a scale of feet denoting the draught of water marked on each side of the stem and of the stern post in Roman capital

letters or in figures, not less than six inches in height, the lower edge of such letters or figures to coincide with the draught denoted thereby, and those letters or figures shall be marked by being cut in or welded and painted white or yellow on a dark background or black on a light background, or in such other way as the Minister may approve.

(5) In the case of ships having a raked soft stem or cruiser stern, the marks shall be cut in or welded as close to the stem as possible following the contour of the stem. The marks at the stern shall be cut in or welded as near as possible to the after perpendicular.

(6) Pleasure craft shall be exempt from the provisions of subregulation (3).

(7) Pleasure craft which, because of their special design cannot comply with subregulation (1)(b) with respect to the marking of the name on each bow, may instead have the name marked on two boards to be fixed to the deck or superstructure amidships on either side.

**12.** For the purposes of these Regulations the Port of Registry shall be the port of Port-of-Spain or any other port as the Minister may by Order declare under section 13 of the Act.

**13.** Upon completion of all the requirements for registration under these Regulations, the Registrar shall enter the particulars of the ship in a Register Book and shall issue to the owners of the ship a Certificate of Registry.

**14.** Where any ship built or acquired in a foreign State becomes the property of persons qualified to own a Trinidad and Tobago ship, the owner or master of the ship may apply to the Trinidad and Tobago Consular Officer or other proper officer at the place nearest to where the ship is lying for the issue of a Provisional Certificate of Trinidad and Tobago Registry and such officer may, on production of satisfactory proof of ownership, grant the same to the owner or master.

Temporary pass  
for unregistered  
ship.

**15.** (1) Where an unregistered ship is in a port in Trinidad and Tobago, and the owner has applied for a Trinidad and Tobago Certificate of Registry, and there is a delay in its issuance the owner may apply to the Minister for a temporary pass for the ship to proceed to its next port of call.

(2) The Minister may direct the Registrar to grant a temporary pass provided the ship is proceeding to a port in the Caribbean Community and such pass shall have the same effect as a Certificate of Registry.

(3) Where an unregistered ship is in a port in Trinidad and Tobago and the owner has applied to have the ship registered in a foreign State and—

- (a) there is a delay in the foreign Certificate of Registry or Provisional Certificate of Registry being issued; and
- (b) the owner requests that the ship be allowed to proceed from Trinidad and Tobago before the Foreign Certificate of Registry or Provisional Certificate of Registry is issued to the owner,

he may apply to the Minister for a temporary pass.

(4) The Minister may direct the Registrar to grant a temporary pass provided—

- (a) the owner produces proof that application has been made to register the ship in that foreign State; and
- (b) confirmation is produced that the laws of that foreign State of Registry allow for the issue of temporary passes and the Administration of that State agrees to its issue.

(5) A temporary pass shall be issued for a maximum period of three months and it shall specify the geographical limits within which the pass is valid.

**PART II**

**CHANGES AND ALTERATIONS**

**16.** (1) The name of a registered ship shall not be changed without the prior Consent of the Director. Change of name of ship.

(2) A change in the name of a ship already on the Trinidad and Tobago Register shall not be recorded in the appropriate Register book unless the proposed change has been advertised by the owner in at least two principal newspapers circulating in Trinidad and Tobago and no objection has been lodged with the Registrar within thirty days of the first publication of the said advertisement.

(3) The owner shall also forward to the Registrar—

(a) copies of the newspapers in which the advertisement referred to in subregulation (2) together with an application for the change of name; and

(b) the prescribed fee payable for the change of name.

(4) When the change of name has been approved the Registrar shall issue a Carving and Marking Note and the existing name shall forthwith be replaced by the new name on the bows and the stern of the ship, and the Carving and Marking Note confirming that this has been done in accordance with regulation 11 shall be returned to the Registrar, together with the Certificate of Registry.

(5) Upon receipt of the Carving and Marking Note and the Certificate of Registry the Registrar shall change the ship's name in the Register and in the Certificate of Registry and shall return the Certificate of Registry to the owner.

**17.** (1) Where an application for a change of name of a Trinidad and Tobago ship is made while the ship is in a foreign State, the procedures set out in regulation 16 shall be followed except that a proper officer at or near the port where the change of name is to be effected may receive the Carving and Marking Note and the Certificate of Registry and, if satisfied, change the name in the Certificate or Registry. Change of name of a ship in a foreign State.

(2) The proper officer shall notify the Registrar at the Ship's Port of Registry of the date on which the change of name was made and send a copy of the amended Certificate of Registry to the Registrar.

(3) On receipt of notification of the name change from the proper officer the Registrar shall amend the Register accordingly.

Registration of alterations.

**18.** (1) The notification of alterations made to a Trinidad and Tobago ship shall be accompanied by a Certificate of Survey giving details of the alterations.

(2) Where alterations consist of a change in the dimensions of the engine room or other closed-in spaces, or an addition to or removal of a poop or deck house, an increase or decrease in the crew space or a change from motor screw to steam screw or vice-versa the Registrar shall register the alterations in the Register Book and also in the Certificate of Registry of the ship when it is submitted as required under subregulation (4).

(3) Where the alterations are material, that is to say, alterations in the hull affecting the principal dimensions of a ship or alterations in the means of propulsion, the Registrar shall proceed to register the ship anew and thereupon the requirements for first registration shall apply as appropriate.

(4) Where the alterations have been carried out in Trinidad and Tobago the Certificate of Registry shall be produced to the Registrar within sixty days of the registration of the alterations and the Registrar shall, upon its receipt either record the alterations in the Certificate of Registry or direct that the ship be registered anew as the case may be.

(5) Where the alterations have been carried out in a foreign State and a Provisional Certificate of Registry has been issued or the existing Certificate of Registry has been provisionally endorsed by a proper officer, such provisional or endorsed Certificate shall be produced to the Registrar within ten days of the ship's first arrival thereafter in a port in Trinidad and Tobago or within six months of the date of issue or endorsement of the Certificate, whichever is earlier.

(6) The Registrar shall, upon its receipt either confirm the provisional endorsement of the alterations in the Certificate, issue a replacement Certificate or direct that the ship be registered anew, as the case may be.

(7) When, owing to the extent or type of alterations carried out, the Registrar directs that the ship should be registered anew, application for the registry anew shall be made to the Registrar—

- (a) where the alterations have been carried out in Trinidad and Tobago, within sixty days of the completion of the alterations; and
- (b) where the alterations have been carried out in a foreign State upon the ship's first arrival at a port in Trinidad and Tobago after the alterations were completed, or within six months of the date of the issue of the Provisional Certificate or endorsement of the Certificate of Registry, whichever is earlier.

(8) In all cases any other requirements for registry anew shall also be complied with.

**19.** (1) The registration of any ship may be transferred from one port in Trinidad and Tobago to another on the application to the Registrar made by declaration in writing of all persons appearing on the Register book to be interested therein but that transfer shall not in any way affect the rights of those persons or any of them, and those rights shall in all respects continue in the same manner as if no such transfer had been effected.

Change of Port of Registry.

(2) Where the Registrar approves the proposed change of the ship's Port of Registry then, upon payment of the prescribed fee—

- (a) a Carving and Marking Note authorising the change in the Port of Registry shall be issued to the owner or master of the ship;
- (b) the new Port of Registry shall be marked on the stern in accordance with the relevant requirements

of regulation 11 such that the name of the existing Port of Registry shall be removed from the stern and replaced by the name of the new Port of Registry;

- (c) in the case of a fishing vessel the identity mark on each of the bows shall also, where applicable, be altered as indicated in the Carving and Marking Note;
- (d) the Carving and Marking Note, duly certified by a surveyor and showing that the new Port of Registry has been marked on the stern in accordance with these Regulations, and, in the case of a fishing vessel that the identity mark on each of the bows has been changed, shall be returned to the Registrar;
- (e) the Certificate of Registry shall be delivered up to the Registrar as soon as practicable after the Carving and Marking Note has been returned, but in any case, within sixty days thereafter;
- (f) on the receipt of the above documents the Registrar shall enter in the Register of the new Port of Registry all particulars relating to the ship and the names of all persons interested therein and grant a new Certificate of Registry, and thenceforth such ship shall be considered as registered at the new Port of Registry.

### PART III

#### TRANSFER, COMMISSION AND MORTGAGE

Bill of Sale.

**20.** (1) A transfer of ownership of a registered ship or any shares therein shall be effected by a Bill of Sale in the appropriate form specified in the Schedule to the Act.

(2) In the case of joint ownership, all the joint owners shall join in the execution of the Bill of Sale.

**21.** (1) Upon production of the documents required under regulation 4 by the transferee together with the prescribed fee, the Registrar shall make the necessary entries in the Register and endorse on the Bill of Sale the date and hour of acceptance.

Recording of  
sale transaction.

(2) An endorsement regarding the transfer of ownership shall also be made as soon as possible by the Registrar or a proper officer, on the ship's Certificate of Registry.

**22.** (1) Every instrument of mortgage of a registered ship shall be in the appropriate form specified in the Schedule to the Act or to the First Schedule of these Regulations as appropriate.

Mortgage of  
ship or share  
therein.  
First Schedule.

(2) On presentation of the instrument of mortgage to the Registrar, together with the prescribed fee, the Registrar shall, upon being satisfied that the instrument is properly executed and that it does not contain notice of any trust, express, implied or constructive, record the transaction in the Register with the date and hour of acceptance and endorse on the mortgage instrument the fact of such recording and the date and hour of acceptance.

**23.** Where several mortgages on the same ship are recorded in the Register book their respective priorities shall be indicated in the appropriate column by capital letters, in alphabetical sequence.

Priority of  
mortgages.

**24.** (1) When the mortgage debt is fully discharged, the Registrar shall, upon being satisfied that the receipt endorsed on the instrument of mortgage is in order, and that the endorsement is properly witnessed, record the discharge in the Register book and endorse on the instrument of mortgage the fact of such recording and the date and hour of acceptance.

Discharge of  
mortgage.

(2) A payment of an instalment of a mortgage debt shall not be recorded by the Registrar in the Register book.

**25.** Where a mortgage of a ship is executed or discharged by a company, the Registrar shall not register the mortgage or enter the discharge unless it has been registered with the Registrar of Companies under Part III of the Companies Act or, as the case

Registration of  
mortgages  
executed and  
discharged by  
companies.  
Ch. 81:01.

LAWS OF TRINIDAD AND TOBAGO

MINISTRY OF THE ATTORNEY GENERAL AND LEGAL AFFAIRS

www.legalaffairs.gov.tt

236

Chap. 50:10

Shipping

[Subsidiary]

Shipping (Registration of Ships) Regulations

may be, a memorandum of satisfaction has been entered in the register of charges under that Act.

Endorsement of change of ownership on Certificate of Registry.

**26.** (1) Whenever a change occurs in the ownership of a registered Trinidad and Tobago ship, such change shall be endorsed on the Certificate of Registry by the Registrar or by a proper officer as the case may be.

(2) For the purpose of having the Certificate of Registry endorsed following change of ownership, it shall be delivered to the Registrar forthwith, where the change occurs while the ship is in a Trinidad and Tobago port.

(3) Where a change of ownership occurs while the ship is in a foreign State, the Certificate of Registry shall be delivered forthwith to the proper officer nearest to the port where the ship is lying and the proper officer, acting on behalf of the Registrar, shall endorse the change of ownership on the Certificate.

(4) Where the change of ownership has been endorsed on the Certificate of Registry by a proper officer, the master shall subsequently deliver the Certificate to the Registrar either upon the ship's first arrival at a port in Trinidad and Tobago following the date upon which the change of ownership was endorsed in the Certificate, or within six months thereafter, whichever is earlier, and the Registrar shall, upon being satisfied, confirm the particulars of the endorsement in the Certificate.

PART IV

REGISTRATION OF GOVERNMENT SHIPS AND ABANDONED SHIPS

Registration of Government ships.

**27.** A Government ship may be registered in the same manner as other ships except as provided herein—

- (a) the application for registration shall be made by the Permanent Secretary of the Ministry or the Head of the Department to whom the management of the ship is entrusted or by any other officer nominated in this behalf by the

UNOFFICIAL VERSION

UPDATED TO 31ST DECEMBER 2016

Government or the Minister, as the case may be, and shall contain the following particulars:

- (i) the name and description of the ship;
  - (ii) a statement of the time when and the place where the ship was built, or where the time or the place are not known, a statement to that effect and of her foreign name, if any;
  - (iii) a statement of the nature of the title to the said ship; and
  - (iv) the name of the master;
- (b) neither a Declaration of Ownership nor a Declaration of Transfer shall be necessary;
- (c) the Registrar, upon receiving such application and upon being satisfied that all the necessary formalities have been complied with, shall enter the name of the ship in the Register as belonging to the Government of Trinidad and Tobago;
- (d) the transfer of ownership of a registered Government ship shall be made by a Bill of Sale in the appropriate form omitting the Covenant contained therein and shall be signed on behalf of the Government by a person duly authorised by the Government for that purpose.

**28.** (1) Every ship which is about to be built or is being built or fitted out and which, when completed, is intended to be registered as a Trinidad and Tobago ship, may, pending such registration, be registered in Trinidad and Tobago as a ship under construction with a temporary name and number assigned by the Registrar, provided the owners of the ship are persons qualified to own a Trinidad and Tobago ship.

Registration of ships under construction.

(2) On the registration of any such ship, which after registration, is hereinafter termed a ship under construction, and as a condition precedent thereto, the owner thereof shall deliver to the Registrar, a description of the ship and a statement of the intended port of Registry in the prescribed form.

(3) For the purposes of this Regulation the owner of every ship which is being built shall identify it by painting on a board, maintained near the place within the yard of the builder where the ship is being built, or fitted out, on a dark background, in white or yellow numerals and letters of not less than one decimetre in height and of proportionate breadth, the assigned number, the temporary name and the name of the intended port of Registry.

(4) Where a ship under construction is sold the Bill of Sale shall be filed with the Registrar and on receipt of such Bill of Sale, the Registrar shall enter the particulars thereof in the Register book for ships under construction and endorse on the Bill of Sale the date and hour that the entry was made but the ownership of a ship under construction which is sold shall be deemed to remain unchanged until the requirements of this subregulation have been met.

(5) A ship under construction may be made security for the repayment of a debt or the discharge of any other obligation.

(6) Every instrument of a mortgage for a ship under construction shall be in the prescribed form and shall be registered in the manner provided in regulation 22 and such mortgage for a ship under construction shall be discharged in the manner provided in regulation 24.

(7) Every mortgage for a ship under construction binds the ship under construction to which it relates from the date of execution of the building contract or from the date of commencement of building to the date of completion thereof or to the date of transfer from the register book for ships under construction to the register book for merchant ships or the register book for fishing vessels as the case may be.

(8) Sections 59 to 65 of the Act shall apply *mutatis mutandis* to a mortgage for a ship under construction, except sections 59(1) and 64(1).

Registration of  
abandoned  
ships.

**29.** (1) An application for the registration or re-registration of an abandoned or wrecked ship under section 39 of the Act shall specify whether the owner desires to retain the ship's previous name.

(2) On completion of the requirements for first registration or re-registration of the ship, the Registrar shall make the following entry in the Register in the space allotted for “number, date and port of previous registry, if any”—

“Certificate of seaworthiness, dated at ..... day of ..... 20..... was granted as required under section 39 of the Shipping Act.”

**PART V**

**MISCELLANEOUS**

**30.** (1) In the event of a registered Trinidad and Tobago ship being either actually or constructively lost, taken by the enemy, or broken up, or ceasing by reason of a transfer to persons not qualified to be owners of a Trinidad and Tobago ship, or otherwise to be a Trinidad and Tobago ship, every owner of the ship or any share therein shall, immediately upon obtaining knowledge of the event, where no notice thereof has already been given to the Registrar, give such notice and the Registrar shall make an entry thereof in the Register and the registration of the ship in that Register shall be considered as closed except insofar as it relates to any unsatisfied mortgages or existing certificates of mortgage entered therein.

Delivery up of certificate of ship lost or ceasing to be Trinidad and Tobago owned.

(2) In any such case, except where the ship’s Certificate of Registry is lost or destroyed, the master or owner of the ship shall—

- (a) where the event occurs in Trinidad and Tobago, immediately deliver the Certificate to the Registrar;
- (b) where the event occurs outside Trinidad and Tobago, within ten days after arriving at a port, deliver the Certificate to the proper officer, who shall forthwith forward it to the Registrar.

**31.** (1) The Registrar may, upon the delivery up to him of the Certificate of Registry of a ship, grant a new Certificate in lieu thereof.

Power to grant new Certificate of Registry.

LAWS OF TRINIDAD AND TOBAGO

MINISTRY OF THE ATTORNEY GENERAL AND LEGAL AFFAIRS

www.legalaffairs.gov.tt

240

Chap. 50:10

Shipping

[Subsidiary]

Shipping (Registration of Ships) Regulations

(2) An application for a new Certificate of Registry shall be made to the Registrar.

Provision for loss of certificate.

**32.** (1) In the event of the Certificate of Registry of a ship being mislaid, lost, or destroyed, the Registrar shall grant a replacement Certificate of Registry in lieu of the original Certificate.

(2) Where the ship is in Trinidad and Tobago, the master, or some other person having knowledge of the facts of the case, shall make a declaration stating those facts and the names and descriptions of the registered owners of such ship to the best of the declarant's knowledge and belief and the Registrar shall thereupon grant a replacement Certificate of Registry.

(3) Where the ship is in a foreign State, the declaration shall be made to the proper officer and the proper officer shall issue a Provisional Certificate of Registry containing a statement of the circumstances under which it was granted.

(4) A Provisional Certificate issued under this Regulation shall be delivered to the Registrar within ten days of the ship's first subsequent arrival at a port in Trinidad and Tobago, or within six months of the date of issue of the Provisional Certificate whichever is earlier.

(5) Every replacement Certificate granted to a registered Trinidad and Tobago ship shall be clearly marked "Duplicate" in red ink.

(6) Where a replacement Certificate of Registry has been granted by reason of the original having been mislaid or lost, and such original is subsequently found or received by the owner, the original Certificate shall be surrendered forthwith to the Registrar for cancellation.

Change of name of Company.

**33.** (1) Where a company in whose name a ship has been registered under these Regulations has changed its name subsequent to registration, the Registrar shall, on production of the certificate of incorporation relating to the new name make a note of such change in the Register in respect of each ship owned by the Company.

UNOFFICIAL VERSION

UPDATED TO 31ST DECEMBER 2016

(2) The change of name of the Company shall also be entered on the Certificate of Registry of each ship owned by the Company upon the ship's first subsequent arrival at a port in Trinidad and Tobago or within six months of the date of change of the name of the Company, whichever is earlier.

**34.** (1) In the event of the appointment or change of master of a registered Trinidad and Tobago ship, the owner shall give notice of the appointment or change to the Registrar or to a proper officer and produce the Certificate of Registry to him.

Appointment and change of master.

(2) The Registrar or proper officer shall endorse the name of the master or new master, the date when the appointment or change was made and the number of the certificate of competency or service of the master or new master on the Certificate of Registry.

**35.** Any person may, upon making an application to the Registrar and paying the prescribed fee—

Inspection of the Register, etc.

- (a) inspect a Register;
- (b) obtain certified copies of entries in a Register;
- (c) obtain copies of other documents relating to the registration of ships.

**36.** Subject to these Regulations, a Provisional Certificate of Registry which has been issued to a Trinidad and Tobago ship in a foreign State shall be delivered up to the Registrar within ten days of the ship's first arrival at a port in Trinidad and Tobago subsequent to the date upon which the Provisional Certificate was issued, or within six months of such date of issue, whichever is earlier.

Delivery up of Provisional Certificate of Registry.

**37.** (1) The owner of a Trinidad and Tobago ship to which section 20 of the Act applies shall make application to the Registrar to have a call sign assigned to the ship.

International Radio call sign.

(2) The Registrar shall control the series of call signs.

(3) The call sign assigned to a ship be noted in the Register and shall be endorsed on the Certificate of Registry by the Registrar or by some other person authorised to do so.

**LAWS OF TRINIDAD AND TOBAGO**

MINISTRY OF THE ATTORNEY GENERAL AND LEGAL AFFAIRS

www.legalaffairs.gov.tt

242

**Chap. 50:10**

*Shipping*

[Subsidiary]

*Shipping (Registration of Ships) Regulations*

(4) Upon a call sign being assigned to a ship the Registrar shall inform the Director of Telecommunications accordingly.

Return and Reports.

**38.** On or before the 31st of January each year the Registrar shall submit to the Minister a return showing the number of ships, including their tonnages, registered during the previous year, as well as the total number of ships, including their tonnages, registered in Trinidad and Tobago.

Forms.  
First Schedule.

**39.** Every document referred to in these Regulations shall, where a form therefor has been prescribed in the First Schedule, be in the appropriate form.

Fees.  
Second Schedule.

**40.** Fees shall be levied under these Regulations at the rates and for the purposes specified in the Second Schedule.

Penalties.

**41.** Unless otherwise provided in the Act any person who contravenes any provision of these Regulations is liable to a fine not exceeding one thousand dollars and if the contravention is a continuing one, to a further fine of two hundred dollars per day for each additional day during which the contravention continues.

---

UNOFFICIAL VERSION

UPDATED TO 31ST DECEMBER 2016

**FIRST SCHEDULE**

**FORM NO. R 1**

REPUBLIC OF  
 TRINIDAD AND TOBAGO

**APPLICATION FOR THE REGISTRATION  
 OF A SHIP UNDER CONSTRUCTION**

Temporary Name		Intended Port of Registry		How Propelled			
No. of Decks	No. of Masts	Stem		Stern	No. of Bulkheads		
Description of Construction				Type of Ship			
ESTIMATED MEASUREMENT							
Length		Breadth		Depth		Gross Tonnage	Register Tonnage
Feet	Inches	Feet	Inches	Feet	Inches		
Metres	Centimetres	Metres	Centimetres	Metres	Centimetres		

I, the undersigned .....  
*Full Name*

declare that it is proposed to have a ship built, the particulars of which are contained in the above description, for  
 .....  
*Full Name of Owner* *Address*

by .....  
*Full Name of Builder*

.....  
*Address*

and that it is intended to complete the said ship on or about the ..... day of ..... 20.....  
 and to Register it at the Port of .....

Application is hereby made to have the ship registered as a ship under construction.  
 Dated at ..... on the ..... day of ..... 20.....

IN THE PRESENCE OF

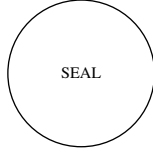
..... <i>Signature</i> ..... <i>Name (Please Print)</i> ..... <i>Address</i> .....	..... <i>Signature</i> ..... <i>Title (Please Print)</i>	
--	---	---

Note: If the owner is a Corporation, the application should be made on behalf of the Corporation by an officer authorised for the purpose and under the Seal of the Corporation.

**FORM NO. R 2**

REPUBLIC OF  
TRINIDAD AND TOBAGO

**MORTGAGE FOR A SHIP UNDER CONSTRUCTION**

..... *Steamship, Motor or Sailing* ..... *Temporary Name* .....

*Record No.		Where Building				When Intended to be Launched	
Intended Port of Registry					Type of Ship		
ESTIMATED MEASUREMENT							
Length		Breadth		Depth		Gross Tonnage	Register Tonnage
Feet	Inches	Feet	Inches	Feet	Inches	Tons	Tons
Metres	Centimetres	Metres	Centimetres	Metres	Centimetres		

I/We (a)† .....

.....(hereinafter called the Mortgagor)

in consideration of (b)† .....

.....

Now covenant with (c)† .....

.....(hereinafter called the Mortgagee)

To pay to the Mortgagee the sums for the time being due on this security, whether by way of principal or interest as the times and in the manner aforesaid. For the purpose of better securing to the Mortgagee the payment of such sums as last aforesaid, the Mortgagor hereby mortgages to the Mortgagee .....<sup>number</sup> shares of which the Mortgagor is the owner in the ship above described, and in its boats and appurtenances. Further, the Mortgagor covenants with the Mortgagee that the Mortgagor has power to mortgage in the manner aforesaid the above-mentioned shares, and that the same are free from encumbrances (d)† .....

Dated at ..... on the ..... day of ..... 20.....

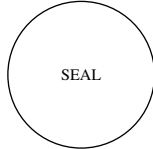
IN THE PRESENCE OF ..... <i>Signature</i> ..... <i>Name (Please Print)</i> ..... <i>Address</i> .....	INDIVIDUAL ..... <i>Signature</i> CORPORATION ..... <i>Signature</i> Per .....	
--	--	---

\* For Official use. † See Notes overleaf.

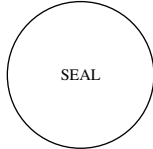
TRANSFER OF MORTGAGE		
I/We .....(Mortgagee)		
in consideration of .....		
paid to me by ..... <div style="text-align: center; font-size: small;"><i>Full Name</i></div> <div style="text-align: center; font-size: small;"><i>Address</i></div>		
hereby transfer the benefit of the within-written security.		
Dated at ..... on the ..... day of ..... 20.....		
IN THE PRESENCE OF	INDIVIDUAL	(MORTGAGEE)
..... <i>Signature</i>	..... <i>Signature</i>	
..... <i>Name (Please Print)</i>	CORPORATION	
..... <i>Address</i>	..... <i>Signature</i>	
.....	Per .....	
DISCHARGE OF MORTGAGE		
Received the sum of .....		
in discharge of the within-written security.		
Dated at ..... on the ..... day of ..... 20.....		
IN THE PRESENCE OF	INDIVIDUAL	MORTGAGEE
..... <i>Signature</i>	..... <i>Signature</i>	
..... <i>Name (Please Print)</i>	CORPORATION	
..... <i>Address</i>	..... <i>Signature</i>	
.....	Per .....	

Maritime Services Division  
 Ship Registration

No. R 2

NOTES:

1. The expression "Mortgagor" and "Mortgagee" used in this document shall include their heirs, successors, assigns, executors, administrators or any other legal representative.
2. The prompt registration of a Mortgage Deed at the Port of Registry of the ship is essential to the security of the mortgage (See section 59 of the Shipping Act, Chap. 50:10).
3. Registered mortgagees are reminded of the importance of keeping the Registrar of Ships informed of any change of residence on their part.
4. (a) Insert the name in full and address of each mortgagor.  
 (b) Describe the nature of the consideration by:
  - (i) entering the principal sum or stating that there is an account current or line of credit and refer to the collateral loan agreement and the date agreement was executed; or
  - (ii) entering the principal sum or stating that there is an account current or line of credit and give details of the interest and method of repayment.
- (c) Insert the name in full and address of each mortgagee.
- (d) If any subsisting encumbrances add "Save as appears by the registry of the said ship".

**LAWS OF TRINIDAD AND TOBAGO**

MINISTRY OF THE ATTORNEY GENERAL AND LEGAL AFFAIRS

www.legalaffairs.gov.tt

246

**Chap. 50:10**

*Shipping*

**[Subsidiary]**

*Shipping (Registration of Ships) Regulations*

**FORM NO. R 3**

REPUBLIC OF  
TRINIDAD AND TOBAGO

**APPLICATION FOR REGISTRATION**

OFFICIAL NUMBER ALLOCATED*	NAME OF SHIP	INTENDED PORT OF REGISTRY

PARTICULARS OF SHIP

<b>Propulsion</b>								
<input type="checkbox"/> None	<input type="checkbox"/> Sail	<input type="checkbox"/> Auxiliary	<input type="checkbox"/> Motor	<input type="checkbox"/> Steam	<input type="checkbox"/> Other (Specify)			
No. of Screws/Paddles, etc.			If sail, how rigged					
<b>Main Dimensions</b>								
LENGTH (Specify)...					Feet	Inches	Metres	Centimetres
.....								
MAXIMUM BREADTH TO OUTSIDE OF HULL								
DEPTH IN HOLD FROM TONNAGE DECK TO CEILING/TANK TOP AMIDSHIPS...								
DEPTH FROM TOP OF UPPER DECK AT SIDE AMIDSHIPS TO BOTTOM OF KEEL								
LENGTH OF ENGINE ROOM (IF ANY)								

**TONNAGE**

Gross Tonnage ...	Tons	Cu. Metres	†Net/Register Tonnage	Tons	Cu. Metres

Type of Ship	Construction Material

Is, or has the ship been previously registered  Yes  No  
If yes, give details of the last registry below:

Official Number	Registered Name	Port of Registry

Is the ship registered as a ship under construction  Yes  No  
If yes, give details of registry below:

Assigned Number	Temporary Name	Place where built

Are all the required documents attached (*See note over*)  Yes  No If no, give details

UNOFFICIAL VERSION

UPDATED TO 31ST DECEMBER 2016

*Shipping*

**Chap. 50:10**

247

*Shipping (Registration of Ships) Regulations*

**[Subsidiary]**

DETAILS OF OWNERS (See NOTE)			
Full Name	Address	Occupation	No. of Shares

.....  
Signature

Date ..... 20.....

.....  
Name (Please Print)

SEAL

Note 1— This application must be made by the owner or the owner’s agent. If an agent is employed, the agent will be required to prove the agency by the production of a written authority under the hand of the owner, or if the owner is a corporation, under the Seal of the corporation.

\* For official use only.  
 † Delete as applicable.

Maritime Services Division  
 Ship Registration

No. R 3

- Note: The following documents, as appropriate, are required to be submitted together with this application:
- (i) Declaration of ownership
  - (ii) Builder’s certificate
  - (iii) Bill of sale where the ship is being purchased
  - (iv) Notice of proposed name of ship
  - (v) Declaration of appointment of managing owner or manager.

---

**LAWS OF TRINIDAD AND TOBAGO**

MINISTRY OF THE ATTORNEY GENERAL AND LEGAL AFFAIRS

www.legalaffairs.gov.tt

248

**Chap. 50:10**

*Shipping*

[Subsidiary]

*Shipping (Registration of Ships) Regulations*

**FORM NO. R 3(G)**

REPUBLIC OF  
TRINIDAD AND TOBAGO

**APPLICATION FOR REGISTRATION OF A GOVERNMENT SHIP**

OFFICIAL NUMBER ALLOCATED*	NAME OF SHIP	INTENDED PORT OF REGISTRY

PARTICULARS OF SHIP

<b>Propulsion</b>						
<input type="checkbox"/> None	<input type="checkbox"/> Sail	<input type="checkbox"/> Auxiliary	<input type="checkbox"/> Motor	<input type="checkbox"/> Steam	<input type="checkbox"/> Other (Specify)	
No. of Screws/Paddles, etc.			If sail, how rigged			
<b>Main Dimensions</b>			Feet	Inches	Metres	Centimetres
LENGTH (Specify)...						
MAXIMUM BREADTH TO OUTSIDE OF HULL						
DEPTH IN HOLD FROM TONNAGE DECK TO CEILING/TANK TOP AMIDSHIPS...						
DEPTH FROM TOP OF UPPER DECK AT SIDE AMIDSHIPS TO BOTTOM OF KEEL						
LENGTH OF ENGINE ROOM (IF ANY)						

**TONNAGE**

Gross Tonnage	Tons	Cu. Metres	†Net/Register Tonnage	Tons	Cu. Metres

Type of Ship	Construction Material

Is, or has the ship been previously registered  Yes  No

If yes, give details of last registry below:

Official Number	Registered Name	Port of Registry

Is the ship registered as a ship under construction  Yes  No

If yes, give details of registry below:

Assigned Number	Temporary Name	Place where built

Are all the required documents attached (*See note over*)  Yes  No If no, give details

Date Built	Name and Address of Builder

UNOFFICIAL VERSION

UPDATED TO 31ST DECEMBER 2016

DETAILS OF OWNERSHIP

Statement as to nature of Title and the Management of the Ship	
..... <i>Signature</i>	..... <i>Name in Full</i>
Date ..... 20 .....	..... <i>Position or Title</i>
* For official use only. † Delete as applicable.	

Maritime Services Division  
Ship Registration

No. R 3(G)

Note: The following documents, as appropriate, are required to be submitted together with this application:

- (i) Builder's certificate
- (ii) Bill of sale where the ship is being purchased
- (iii) Notice of proposed name of ship
- (iv) Declaration of appointment of managing owner or manager.

\_\_\_\_\_

FORM NO. R 4

REPUBLIC OF  
TRINIDAD AND TOBAGO

NOTICE OF PROPOSED NAME FOR A SHIP OR CHANGE OF NAME OF A SHIP

To the Registrar ..... 20 .....

NOTICE OF PROPOSED NAME FOR A SHIP

It is proposed to register at the Port of (1) .....  
the (2) ..... ship\* now being built for me/us by (3) .....  
..... of .....  
\*acquired by me/us from (4) .....  
by the name .....

NOTICE OF PROPOSED CHANGE OF NAME FOR A REGISTERED SHIP

It is proposed to change the name of the (2) .....ship  
(5) ..... registered at the Port of  
(1) ..... Official Number/Identity Mark .....  
to (6) .....

Copies of newspaper advertisement as required by regulation 16 of The Shipping (Registration of Ships) Regulations 1987 are attached.

.....  
*Signature*

.....  
*Title*

NOTES—

- (1) Intended Port of Registry or Port of Registry
- (2) Non-Propelled, Sail, Auxiliary, Motor or Steam, etc.
- (3) Name of builder if new ship
- (4) Name of person or company from whom acquired
- (5) Present registered name of ship
- (6) New name of ship requested

\* Delete as applicable.

If the owner is a corporation, the notice should be made on behalf of the corporation by an officer of the corporation authorised for the purpose and under the seal of the corporation.

SEAL

FORM NO. R 5

REPUBLIC OF  
 TRINIDAD AND TOBAGO

BUILDER'S CERTIFICATE

OFFICIAL NUMBER ALLOCATED •	BUILDER'S IDENTIFICATION OR NAME OF SHIP	PORT OF REGISTRY •

PARTICULARS OF SHIP

<b>Propulsion</b>								
<input type="checkbox"/> None	<input type="checkbox"/> Sail	<input type="checkbox"/> Auxiliary	<input type="checkbox"/> Motor	<input type="checkbox"/> Steam	<input type="checkbox"/> Other (Specify)			
No. of Screws/Paddles, etc.		If sail, how rigged						
<b>Main Dimensions</b>								
LENGTH (Specify)...	...	...	...	...	Feet	Inches	Metres	Centimetres
.....								
MAXIMUM BREADTH TO OUTSIDE OF HULL ... ..								
DEPTH IN HOLD FROM TONNAGE DECK TO CEILING/TANK TOP AMIDSHIPS...								
DEPTH FROM TOP OF UPPER DECK AT SIDE AMIDSHIPS TO BOTTOM OF KEEL								
LENGTH OF ENGINE ROOM (IF ANY) ... ..								

TONNAGE

	Tons	Cu. Metres		Tons	Cu. Metres
Gross Tonnage ...			†Net/Register Tonnage		
NAME AND ADDRESS OF BUILDER					
.....					
.....					
.....					

DETAILS OF OWNERS

Full Name	Address	Occupation	No. of Shares

I, the undersigned, builder of the ship described above hereby certify that the dimensions and tonnage, as estimated by me, and the other particulars here given are correct.

.....  
*Signature*

Date ..... 20.....

.....  
*Name (Please Print)*

SEAL

Note 1 — If builder is a Corporation, the certificate should be made on behalf of the Corporation by an officer of the Corporation authorised for the purpose and under the Seal of the Corporation.

Note 2 — If this certificate is given by an unincorporated firm consisting of two or more partners, the certificate should be signed by a partner for Messrs. C., D. and E.

• For official use only.  
 † Delete as applicable.

**LAWS OF TRINIDAD AND TOBAGO**

MINISTRY OF THE ATTORNEY GENERAL AND LEGAL AFFAIRS

www.legalaffairs.gov.tt

252

**Chap. 50:10**

*Shipping*

[Subsidiary]

*Shipping (Registration of Ships) Regulations*

**FORM NO. R 6**

REPUBLIC OF  
TRINIDAD AND TOBAGO

**DECLARATION OF OWNERSHIP OR DECLARATION OF TRANSFER**

OFFICIAL NUMBER •	NAME OF SHIP	No.	YEAR	PORT OF REGISTRY

**PARTICULARS OF SHIP**

<b>Propulsion</b>						
<input type="checkbox"/> None	<input type="checkbox"/> Sail	<input type="checkbox"/> Auxiliary	<input type="checkbox"/> Motor	<input type="checkbox"/> Steam	<input type="checkbox"/> Other (Specify)	
No. of Screws/Paddles, etc.			If sail, how rigged			
<b>Main Dimensions</b>						
LENGTH (Specify)...			Feet	Inches	Metres	Centimetres
MAXIMUM BREADTH TO OUTSIDE OF HULL						
DEPTH IN HOLD FROM TONNAGE DECK TO CEILING/TANK TOP AMIDSHIPS						
DEPTH FROM TOP OF UPPER DECK AT SIDE AMIDSHIPS TO BOTTOM OF KEEL						
LENGTH OF ENGINE ROOM (IF ANY)						

**TONNAGE**

Gross Tonnage	Tons	Cu. Metres	†Net/Register Tonnage	Tons	Cu. Metres

Type of Ship	Construction Material

and as described in more detail in the Certificate of Survey

I, .....  
*Full Name*  
of .....  
*Address*  
Occupation ..... Nationality .....

DECLARE AS FOLLOWS:  
1. The above general description of the ship is correct.

2. INDIVIDUAL:  
I am qualified to own a Trinidad and Tobago ship and I am entitled to be registered as  
 Owner of ..... shares  
or  
 Joint Owner of ..... shares with those whose names are listed:

CORPORATION:  
I am .....  
*Office held* ..... *Name of Corporation* .....

Incorporated by virtue of .....  
*Law under which it was incorporated* .....

and which has its principal place of business at .....

The said Corporation is entitled to be registered as  Owner of ..... shares  
or  
 Joint Owner of ..... shares with those whose names are listed:

• To be completed on transfer of ownership only.  
† Delete as applicable.

Maritime Services Division  
Ship Registration

No. R 6  
(Continued over)

UNOFFICIAL VERSION

UPDATED TO 31ST DECEMBER 2016

List of remaining joint owners <i>(if applicable)</i>		
Full Name	Address	Occupation

**3. STATEMENT OF CONSTRUCTION**

YEAR BUILT	PLACE BUILT	IF FOREIGN, STATE THE FOREIGN NAME			
<p>(To be completed in the case of a ship which has been condemned)</p> <p>The ship was condemned</p> <p style="text-align: center;">by ..... <i>Name of Court</i></p> <p>at ..... on ..... <i>Place of Condemnation</i> <span style="float: right;"><i>Date of Condemnation</i></span></p>					
<p>4. The name of the Master is .....</p> <p>whose Certificate of Competency or Service is ..... <i>Number</i></p>					
<p>5. To the best of my knowledge and belief no unqualified person or body of persons is entitled as owner to any legal or beneficial interest in the ship or any share therein.</p> <table style="width: 100%; border: none;"> <tr> <td style="width: 45%; vertical-align: top; border: none;"> <p>DECLARED BEFORE ME</p> <p>this ..... day of ..... 20 .....</p> <p>..... <i>Signature</i></p> <p>..... <i>Name (Please Print)</i></p> <p>..... <i>Address</i></p> <p>.....</p> </td> <td style="width: 5%; vertical-align: middle; border: none; text-align: center;">}</td> <td style="width: 45%; vertical-align: top; border: none;"> <p>INDIVIDUAL</p> <p>..... <i>Signature</i></p> <p>CORPORATION</p> <p>..... <i>Signature</i></p> </td> </tr> </table> <div style="text-align: right; margin-top: 20px;">  </div>			<p>DECLARED BEFORE ME</p> <p>this ..... day of ..... 20 .....</p> <p>..... <i>Signature</i></p> <p>..... <i>Name (Please Print)</i></p> <p>..... <i>Address</i></p> <p>.....</p>	}	<p>INDIVIDUAL</p> <p>..... <i>Signature</i></p> <p>CORPORATION</p> <p>..... <i>Signature</i></p>
<p>DECLARED BEFORE ME</p> <p>this ..... day of ..... 20 .....</p> <p>..... <i>Signature</i></p> <p>..... <i>Name (Please Print)</i></p> <p>..... <i>Address</i></p> <p>.....</p>	}	<p>INDIVIDUAL</p> <p>..... <i>Signature</i></p> <p>CORPORATION</p> <p>..... <i>Signature</i></p>			

**NOTES:**

- 1— Qualifications to own a ship registered in Trinidad and Tobago are set out in section 4 of the Shipping Act, Chap. 50:10.
- 2— Declarations shall be made before a Registrar or Justice of the Peace, or a Commissioner for Oaths, or a Consular Officer or before any person authorised by law to administer oaths.
- 3— Declarations may be made on behalf of a Corporation by an officer of the Corporation authorised by it for the purpose. Such authorisation may be evidenced by the affixing of the Seal of the Corporation to this declaration or a document in writing executed by the Corporation under its Seal in which the declarant is authorised to sign on its behalf.

FORM NO. R 7

REPUBLIC OF  
TRINIDAD AND TOBAGO

DECLARATION OF  
APPOINTMENT OF MANAGING OWNER OR MANAGER

TO THE REGISTRAR

..... 20 .....

I/We, the undersigned being owner(s) of..... shares of the (1) .....

..... of (2) .....

whose Official Number/Identity Mark is ..... and of .....tons net/register,\* hereby

appoint (3).....

.....

to be (4).....

.....  
*Signature*.....

.....  
*Title*.....

SEAL

(1) Sailing, Steam or Motor, and name of ship  
(2) Port of Registry  
(3) Name, address and occupation  
(4) Managing owner or Manager

If the owner is a corporation, this declaration should be made on behalf of the corporation by an officer of the corporation authorised for the purpose and under the seal of the corporation.

\*Delete as applicable.

**FORM NO. R 8/T 2**

REPUBLIC OF  
TRINIDAD AND TOBAGO

**CERTIFICATE OF SURVEY  
(Tonnage Measurement)**

OFFICIAL NUMBER	NAME OF SHIP	No.	YEAR	PORT OF REGISTRY

PARTICULARS OF SHIP

<b>Propulsion</b>				
<input type="checkbox"/> None <input type="checkbox"/> Sail <input type="checkbox"/> Auxiliary <input type="checkbox"/> Motor <input type="checkbox"/> Steam <input type="checkbox"/> Other (Specify)				
No. of Screws/Paddles, etc.			If sail, how rigged	
<b>Main Dimensions</b>				
LENGTH (Specify)...	Feet	Inches	Metres	Centimetres
.....				
MAXIMUM BREADTH TO OUTSIDE OF HULL				
DEPTH IN HOLD FROM TONNAGE DECK TO CEILING/TANK TOP AMIDSHIPS				
DEPTH FROM TOP OF UPPER DECK AT SIDE AMIDSHIPS TO BOTTOM OF KEEL				
LENGTH OF ENGINE ROOM (IF ANY)				
NO. OF DECKS	NO. OF MASTS	NO. OF BULKHEADS	STEM	STERN
WHERE BUILT		DATE BUILT	NAME AND ADDRESS OF BUILDER	
TYPE OF SHIP	CONSTRUCTION MATERIAL			

PARTICULARS OF TONNAGE

Delete if not applicable	<p>The tonnages of this ship, in accordance with its International or Trinidad and Tobago Tonnage Certificate are:</p> <p>GROSS TONNAGE .....tons    ( .....cubic metres)</p> <p>NET/REGISTER TONNAGE .....tons    ( .....cubic metres)</p> <p>This ship is assigned with a tonnage mark on each side of the ship which is ..... inches below the upper deck line and when this mark is submerged the above tonnages are applicable. When the tonnage mark is NOT submerged the following tonnages are applicable:</p> <p>GROSS TONNAGE ..... tons    ( .....cubic metres)</p> <p>NET/REGISTER TONNAGE..... tons    ( .....cubic metres)</p> <p>A detailed summary of the tonnages for the ship is shown on its International or Trinidad and Tobago Tonnage Certificate.</p>
--------------------------	---

PARTICULARS OF PROPELLING ENGINES, ETC.

No. of Engines	Type of Engines	Power		Boilers	
		KW		No.	
No. of Shafts	Name and Address of Maker	N.H.P.		Type	
		B.H.P.		Load Pressure	
Date Made		I.H.P.		Date Made	
		Estd. Spd.			

**LAWS OF TRINIDAD AND TOBAGO**

MINISTRY OF THE ATTORNEY GENERAL AND LEGAL AFFAIRS

www.legalaffairs.gov.tt

256

**Chap. 50:10**

*Shipping*

**[Subsidiary]**

*Shipping (Registration of Ships) Regulations*

**FORM NO. R 8/T 2—Continued**

The number of seamen and apprentices for whom accommodation is certified .....
I, the undersigned Surveyor appointed by the Minister, having surveyed the above-named ship, hereby certify that the above particulars are true. Dated at ..... this ..... day of ..... 20.....  ..... <i>Surveyor</i>

Maritime Services Division  
Ship Registration

No. R 8/T 2

\_\_\_\_\_

UNOFFICIAL VERSION

UPDATED TO 31ST DECEMBER 2016

FORM NO. R 8/T 2—T

REPUBLIC OF  
 TRINIDAD AND TOBAGO

CERTIFICATE OF SURVEY  
 (Tonnage Measurement)  
 (Tug)

OFFICIAL NUMBER	NAME OF SHIP	No.	YEAR	PORT OF REGISTRY

PARTICULARS OF SHIP

<b>Propulsion</b>				
<input type="checkbox"/> None <input type="checkbox"/> Sail <input type="checkbox"/> Auxiliary <input type="checkbox"/> Motor <input type="checkbox"/> Steam <input type="checkbox"/> Other (Specify)				
No. of Screws/Paddles, etc.		If sail, how rigged		
<b>Main Dimensions</b>				
	Feet	Inches	Metres	Centimetres
LENGTH (Specify)...				
MAXIMUM BREADTH TO OUTSIDE OF HULL				
DEPTH IN HOLD FROM TONNAGE DECK TO CEILING/TANK TOP AMIDSHIPS...				
DEPTH FROM TOP OF UPPER DECK AT SIDE AMIDSHIPS TO BOTTOM OF KEEL				
LENGTH OF ENGINE ROOM (IF ANY)				

NO. OF DECKS	NO. OF MASTS	NO. OF BULKHEADS	STEM	STERN
WHERE BUILT		DATE BUILT	NAME AND ADDRESS OF BUILDER	
TYPE OF SHIP	CONSTRUCTION MATERIAL			

PARTICULARS OF TONNAGE

The tonnages of this ship, in accordance with its International or Trinidad and Tobago Tonnage Certificate are:	
GROSS TONNAGE .....	tons ( .....cubic metres)
NET/REGISTER TONNAGE .....	tons ( .....cubic metres)
If and when employed for the carriage of passengers, cargo or stores, or using graving docks or dry docks or places provided for the repairing of vessels, the register tonnage on which dues based on register tonnage may be levied by any harbour or dock authority is ..... tons.	
A detailed summary of the tonnages for the ship is shown on its International or Trinidad and Tobago Tonnage Certificate.	

PARTICULARS OF PROPELLING ENGINES, ETC.

No. of Engines	Type of Engines	Power		Boilers	
		KW		No.	
No. of Shafts	Name and Address of Maker	N.H.P.		Type	
		B.H.P.		Load Pressure	
Date made		I.H.P.		Date made	
		Estd. Spd.			

The number of seamen and apprentices for whom accommodation is certified .....

I, the undersigned Surveyor appointed by the Minister, having surveyed the above-named ship, hereby certify that the above particulars are true.
Dated at ..... this ..... day of ..... 20.....
..... Surveyor

**LAWS OF TRINIDAD AND TOBAGO**

MINISTRY OF THE ATTORNEY GENERAL AND LEGAL AFFAIRS

www.legalaffairs.gov.tt

258

**Chap. 50:10**

*Shipping*

**[Subsidiary]**

*Shipping (Registration of Ships) Regulations*

**FORM NO. R 9**

REPUBLIC OF  
TRINIDAD AND TOBAGO

**CARVING AND MARKING NOTE**

NAME OF SHIP	*OFFICIAL NUMBER/ IDENTITY MARK	PORT OF REGISTRY	*NET/REGISTER TONNAGE

- (1) The Official Number/Identity Mark and the Net/Register Tonnage is to be cut into the main structure of the ship.
- (2) The Name of the Ship/Identity Mark is to be marked on each bow of the ship.
- (3) The Name of the ship and its Port of Registry, or in the case of a Fishing Vessel its Port of Registry only, is to be marked on the stern of the ship.
- (4) A scale of decimetres or metres and decimetres is to be cut in or welded on each side of the stem and on each side of the stern post. In a ship without a stern post, then as close to the stern as possible; in the case of existing ships the scale may be in feet.

The above marking shall be in accordance with <sup>†</sup>regulation 11 of the Shipping (Registration of Ships) Regulations 1987.

PORT OF	DATE	REGISTRAR

I have inspected the above ship and certify that the Official Number/Identity Mark and the Net/Register Tonnage as stated are permanently and conspicuously cut in on its main structure, that the Name/Identity Mark is marked on each bow, that the name/the name and its Port of Registry is/are\* marked on the stern, and that the draft marks have been cut in and marked in a manner directed by the Regulations above mentioned.

PLACE WHERE SHIP LYING	DATE	SURVEYOR OR PROPER OFFICER
		<p align="center">..... <i>Signature</i> .....</p> <p align="center">..... <i>Title</i> .....</p>

\*Delete as applicable.

<sup>†</sup> See following page for Regulation 11.

Maritime Services Division  
Ship Registration

No. R 9

UNOFFICIAL VERSION

UPDATED TO 31ST DECEMBER 2016

**Regulation 11**

Carving and Marking of Ships

11. Every ship shall, prior to registration, be marked permanently and conspicuously to the satisfaction of the Registrar in the manner provided herein:

- (1) (a) In the case of a fishing vessel the identity mark allocated to the ship shall be marked on each of the bows and the intended Port of Registry shall be marked on the stern.
  - (b) In the case of any other ship, the name shall be marked on each of the bows and the name and the intended Port of Registry shall be marked on the stern.
  - (c) In all cases the marking shall be in white or yellow numerals or letters on a dark background or in black numerals or letters on a light background.
  - (d) The numerals or letters shall be not less than one decimetre in height and of proportionate breadth.
- (2) The identity mark allotted in the case of a fishing vessel and the official number allotted to any other type of ship, together with, in all cases, the number denoting the ship's net tonnage, shall be permanently cut in or welded on the ship's main structure in a conspicuous place as approved by the surveyor.
- (3) A scale of decimetres, or of metres and decimetres, denoting a draught of water, shall be marked on each side of the stem and of the stern post—
- (a) in figures at two-decimetre intervals, where the scale is in decimetres; and
  - (b) in figures at each metre interval and at intervening two-decimetre intervals, where the scale is in metres and decimetres, the capital letter "M" being placed after each metre figure; the top figure on the scale showing both the metre and (except where it marks a full metre interval) the decimetre figure; the lower edge of the figures, or figures and letters (as the case may be), coinciding with the draught denoted thereby; the figures and letters being not less than one decimetre in height and marked by being cut in or welded and painted white or yellow on a dark background or black on a light background, or in such other way as the Minister may approve.
- (4) In the case of an existing ship the draught marks may take the form of a scale of feet denoting the draught of water marked on each side of

**Regulation 11—Continued****FORM NO. R 9—Continued**

the stem and of the stern post in Roman capital letters or in figures, not less than six inches in height, the lower edge of such letters or figures to coincide with the draught denoted thereby, and those letters or figures shall be marked by being cut in or welded and painted white or yellow on a dark background or black on a light background, or in such other way as the Minister may approve.

- (5) In the case of ships having a raked soft stem or cruiser stern, the marks shall be cut in or welded as close to the stem as possible following the contour of the stem. The marks at the stern shall be cut in or welded as near as possible to the after perpendicular.
- (6) (a) Pleasure craft shall be exempt from the provisions of regulation 11(3).
- (b) Pleasure craft which, because of their special design, cannot comply with regulation 11(1)(b) with respect to the marking of the name on each bow, may instead have the name marked on two boards to be fixed to the deck or superstructure amidships on either side.

FORM NO. R 10

REPUBLIC OF  
 TRINIDAD AND TOBAGO

CERTIFICATE OF REGISTRY

OFFICIAL NUMBER	NAME OF SHIP	No.	YEAR	PORT OF REGISTRY
PARTICULARS OF SHIP				
<b>Propulsion</b>				
<input type="checkbox"/> None <input type="checkbox"/> Sail <input type="checkbox"/> Auxiliary <input type="checkbox"/> Motor <input type="checkbox"/> Steam <input type="checkbox"/> Other (Specify)				
No. of Screws/Paddles, etc.		If sail, how rigged		
<b>Main Dimensions</b>				
		Feet	Inches	Metres
LENGTH (Specify)...				Centimetres
MAXIMUM BREADTH TO OUTSIDE OF HULL				
DEPTH IN HOLD FROM TONNAGE DECK TO CEILING/TANK TOP AMIDSHIPS				
DEPTH FROM TOP OF UPPER DECK AT SIDE AMIDSHIPS TO BOTTOM OF KEEL				
LENGTH OF ENGINE ROOM (IF ANY)				
NO. OF DECKS	NO. OF MASTS	NO. OF BULKHEADS	STEM	STERN
WHERE BUILT		DATE BUILT	NAME AND ADDRESS OF BUILDER	
TYPE OF SHIP	CONSTRUCTION MATERIAL			
PARTICULARS OF TONNAGE				
The tonnages of this ship, in accordance with its International or Trinidad and Tobago Certificate are:				
GROSS TONNAGE.....tons ( .....cubic metres)				
NET/REGISTER TONNAGE .....tons ( .....cubic metres)				
Delete if not applicable	This ship is assigned with a tonnage mark on each side of the ship which is .....inches below the upper deck line and when this mark is submerged the above tonnage as applicable. When the tonnage mark is NOT submerged the following tonnages are applicable:			
	GROSS TONNAGE.....tons ( .....cubic metres)			
	NET/REGISTER TONNAGE .....tons ( .....cubic metres)			
	A detailed summary of the tonnages for the ship is shown on its International or Trinidad and Tobago Tonnage Certificate.			
PARTICULARS OF PROPELLING ENGINES, ETC.				
No. of Engines	Type of Engines	Power		Boilers
No. of Shafts	Name and Address of Maker	KW	No.	No.
Date made		N.H.P.	Type	Type
		B.H.P.	Load Pressure	Load Pressure
		I.H.P.	Date Made	Date Made
		Estd. Spd.		
The number of seamen and apprentices for whom accommodation is certified .....				
DETAILS OF OWNERS				
Full Name of Owners	Address	Occupation	No. of Shares	
Name of Master	No. of Certificate of Competency or Service			
I, the undersigned Registrar of Ships, hereby certify that the above particulars are correct.				
Dated at ..... on the .....day of ..... 20.....				
Signature		Port of Registry		
Name (Please Print)				
Note: A certificate of Registry is not a document of title. It does not necessarily contain notice of all changes of ownership and in no case does it contain an official record of any mortgages affecting the ship. In case of any change of ownership, it is important for the change to be registered. Should the vessel be lost, sold to foreigners or broken up, notice thereof, together with the Certificate of Registry, if in existence, should immediately be given to the Registrar of Ships at the Ship's Port of Registry.				

Maritime Services Division  
 Ship Registration

No. R 10  
 (continued over)

UNOFFICIAL VERSION

L.R.O.

UPDATED TO 31ST DECEMBER 2016

**LAWS OF TRINIDAD AND TOBAGO**

MINISTRY OF THE ATTORNEY GENERAL AND LEGAL AFFAIRS

www.legalaffairs.gov.tt

262

**Chap. 50:10**

*Shipping*

[Subsidiary]

*Shipping (Registration of Ships) Regulations*

**FORM NO. R 10—Continued**

OFFICIAL NUMBER .....

NAME OF SHIP.....

**ENDORSEMENT OF CHANGE OF MASTER**

Date	Full Name	Certificate of Competency (or Service) No.	Signature (See Note)

NOTE: Where the master of a Trinidad and Tobago ship is changed, each of the following persons:

- (a) a Registrar or Deputy Registrar of Ships;
  - (b) a Trinidad and Tobago Consular Officer;
  - (c) a proper officer appointed by the Government of Trinidad and Tobago;
- shall endorse and sign a memorandum of the change.

UNOFFICIAL VERSION

UPDATED TO 31ST DECEMBER 2016



**LAWS OF TRINIDAD AND TOBAGO**

MINISTRY OF THE ATTORNEY GENERAL AND LEGAL AFFAIRS

www.legalaffairs.gov.tt

264

**Chap. 50:10**

*Shipping*

[Subsidiary]

*Shipping (Registration of Ships) Regulations*

**FORM NO. R 10—T—Continued**

OFFICIAL NUMBER .....

NAME OF SHIP.....

**ENDORSEMENT OF CHANGE OF OWNERSHIP**

Date	Full Name	Address	Occupation	No. of Shares	Signature of Registrar

NOTE: Whenever a change occurs in the registered ownership of a registered ship, the change of ownership shall be endorsed on the Certificate of Registry by a Registrar or Deputy Registrar at the ship's Port of Registry. If the ship arrives at a port, other than the ship's Port of Registry, then the endorsement shall be made by a Trinidad and Tobago Consular Officer or other proper officer who has been authorised to do so by the Registrar at the ship's Port of Registry.

UNOFFICIAL VERSION

UPDATED TO 31ST DECEMBER 2016

FORM NO. R 11

REPUBLIC OF  
 TRINIDAD AND TOBAGO

BILL OF SALE

OFFICIAL NUMBER	NAME OF SHIP	No.	YEAR	PORT OF REGISTRY

PARTICULARS OF SHIP

<b>Propulsion</b>				
<input type="checkbox"/> None <input type="checkbox"/> Sail <input type="checkbox"/> Auxiliary <input type="checkbox"/> Motor <input type="checkbox"/> Steam <input type="checkbox"/> Other (Specify)				
No. of Screws/Paddles, etc.			If sail, how rigged	
<b>Main Dimensions</b>				
	Feet	Inches	Metres	Centimetres
LENGTH (Specify)...				
MAXIMUM BREADTH TO OUTSIDE OF HULL				
DEPTH IN HOLD FROM TONNAGE DECK TO CEILING/TANK TOP AMIDSHIPS				
DEPTH FROM TOP OF UPPER DECK AT SIDE AMIDSHIPS TO BOTTOM OF KEEL				
LENGTH OF ENGINE ROOM (IF ANY)				

TONNAGE

	Tons	Cu. Metres		Tons	Cu. Metres
Gross Tonnage			*Net/Register Tonnage		

I/We (a) .....  
 (hereinafter called the Transferor) in consideration of the sum of .....  
 paid to me by (b) .....  
 (hereinafter called the Transferee) the Receipt whereof is hereby acknowledged, transfer to the Transferee ..... shares  
 in the above-described, and in its boats and appurtenances. Number of

Further, the Transferor covenants with the Transferee that the Transferor has power to transfer in manner aforesaid the premises  
 hereinbefore expressed to be transferred and that the same are free from encumbrances (c).....

Dated at ..... on the ..... day of ..... 20.....

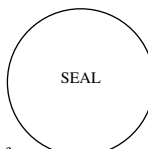
IN THE PRESENCE OF ..... Signature Name (Please Print) Address	}	INDIVIDUAL                      TRANSFEROR ..... ..... CORPORATION Per .....	
--	---	--	---

(a) Insert the name in full and address of each registered owner. (b) Insert the name in full of each Transferee.  
 NOTE: Where there is more than one Transferee, the Transferees are joint owners. (c) If any subsisting encumbrances, add  
 "Save as appears on the registry of the said ship."  
 \*Delete as applicable.

- NOTES:
- 1— The expression "Transferor" and "Transferee" used in this document shall include their heirs, successors, assigns, executors and administrators or any other legal representative.
  - 2— Registered owners are reminded of the importance of keeping the Registrar of Ships informed of any changes of residence on their part.
  - 3— The attention of purchasers is drawn to section 54 of the Shipping Act, Chap. 50:10.

**LAWS OF TRINIDAD AND TOBAGO**

MINISTRY OF THE ATTORNEY GENERAL AND LEGAL AFFAIRS

www.legalaffairs.gov.tt

266

**Chap. 50:10**

*Shipping*

[Subsidiary]

*Shipping (Registration of Ships) Regulations*

**FORM NO. R 12**

REPUBLIC OF  
TRINIDAD AND TOBAGO

**MORTGAGE**

OFFICIAL NUMBER	NAME OF SHIP	No.	YEAR	PORT OF REGISTRY

PARTICULARS OF SHIP

<b>Propulsion</b>				
<input type="checkbox"/> None	<input type="checkbox"/> Sail	<input type="checkbox"/> Auxiliary	<input type="checkbox"/> Motor	<input type="checkbox"/> Steam
			<input type="checkbox"/> Other (Specify)	
No. of Screws/Paddles, etc.			If sail, how rigged	
<b>Main Dimensions</b>				
LENGTH (Specify)...	Feet	Inches	Metres	Centimetres
.....				
MAXIMUM BREADTH TO OUTSIDE OF HULL				
DEPTH IN HOLD FROM TONNAGE DECK TO CEILING/TANK TOP AMIDSHIPS...				
DEPTH FROM TOP OF UPPER DECK AT SIDE AMIDSHIPS TO BOTTOM OF KEEL				
LENGTH OF ENGINE ROOM (IF ANY)				

**TONNAGE**

	Tons	Cu. Metres		Tons	Cu. Metres
Gross Tonnage			*Net/Register Tonnage		

and as described in more detail in the Certificate of Survey and the Register Book.

I/We (a) .....  
 ..... (hereinafter called the Mortgagor)  
 in consideration of (b) .....  
 .....  
 Now covenant with (c) .....  
 ..... (hereinafter called the Mortgagee)

To pay to the Mortgagee the sums for the time being due on this security, whether by way of principal or interest at the times and in the manner aforesaid. For the purpose of better securing to the Mortgagee the payment of such sums as last aforesaid, the Mortgagor hereby mortgages to the Mortgagee ..... shares of which the Mortgagor is the owner in the ship above described, and in its boats and appurtenances. Further, the Mortgagor covenants with the Mortgagee that the Mortgagor has power to mortgage in the manner aforesaid the above-mentioned shares, and that the same are free from encumbrances (d) .....

Dated at ..... on the ..... day of ..... 20.....

IN THE PRESENCE OF	} INDIVIDUAL	.....	CORPORATION	○ SEAL
Signature		Signature		
Name (Please Print)		Signature		
Address	Per	.....		

\*Delete as applicable.

Maritime Services Division  
Ship Registration

No. R 12  
(See Notes overleaf)

UNOFFICIAL VERSION

UPDATED TO 31ST DECEMBER 2016

TRANSFER OF MORTGAGE		
I/We .....(MORTGAGEE)		
in consideration of .....		
paid to me by .....		
<i>Full Name</i>		
.....		
<i>Address</i>		
hereby transfer the benefit of the within-written security.		
Dated at ..... on the ..... day of ..... 20.....		
IN THE PRESENCE OF	INDIVIDUAL	MORTGAGEE
.....	.....	
<i>Signature</i>	<i>Signature</i>	
.....	CORPORATION	
<i>Name (Please Print)</i>	.....	
.....	<i>Signature</i>	
<i>Address</i>	Per .....	
.....		

DISCHARGE OF MORTGAGE		
Received the sum of .....		
in discharge of the within-written security.		
Dated at ..... on the ..... day of ..... 20.....		
IN THE PRESENCE OF	INDIVIDUAL	MORTGAGEE
.....	.....	
<i>Signature</i>	<i>Signature</i>	
.....	CORPORATION	
<i>Name (Please Print)</i>	.....	
.....	<i>Signature</i>	
<i>Address</i>	Per .....	
.....		

NOTES:

1. The expression "Mortgagor" and "Mortgagee" used in this document shall include their heirs, successors, assigns, executors, administrators or any other legal representative.
2. The prompt registration of a Mortgage Deed at the Port of Registry of the ship is essential to the security of the mortgagee.
3. Registered mortgagees are reminded of the importance of keeping the Registrar of Ships informed of any change of residence on their part.
4. (a) Insert the name in full and address of each mortgagor.  
(b) Describe the nature of the consideration by:  
(i) entering the principal sum or stating that there is an account current or line of credit and refer to the collateral loan agreement and the date agreement was executed; or  
(ii) entering the principal sum or stating that there is an account current or line of credit and give details of the interest and method of repayment.  
(c) Insert the name in full and address of each mortgagee.  
(d) If any subsisting encumbrances add "Save as appears by the registry of the said ship".

**FORM NO. R 13**

REPUBLIC OF  
TRINIDAD AND TOBAGO

**APPLICATION FOR A CERTIFICATE OF SALE**

OFFICIAL NUMBER	NAME OF SHIP	No.	YEAR	PORT OF REGISTRY

PARTICULARS OF SHIP

<b>Propulsion</b>				
<input type="checkbox"/> None <input type="checkbox"/> Sail <input type="checkbox"/> Auxiliary <input type="checkbox"/> Motor <input type="checkbox"/> Steam <input type="checkbox"/> Other (Specify)				
No. of Screws/Paddles, etc.			If sail, how rigged	
<b>Main Dimensions</b>				
	Feet	Inches	Metres	Centimetres
LENGTH (Specify).....				
.....				
MAXIMUM BREADTH TO OUTSIDE OF HULL .....				
DEPTH IN HOLD FROM TONNAGE DECK TO CEILING/TANK TOP AMIDSHIPS.....				
DEPTH FROM TOP OF UPPER DECK AT SIDE AMIDSHIPS TO BOTTOM OF KEEL.....				
LENGTH OF ENGINE ROOM (IF ANY) .....				

<b>TONNAGE</b>					
	Tons	Cu. Metres		Tons	Cu. Metres
Gross Tonnage .....			*Net/Register Tonnage .....		

I/We the undersigned, Owner(s) of the Ship described above, hereby appoint.....  
*Full Name*

.....  
*Address*

my/our attorney in my/our name and on my/our behalf to sell the above Ship, and to execute and do all such deeds, matters and things as may be necessary for carrying into effect the power hereby given. I/We declare that the Ship shall not be sold for a sum less than .....

I/We declare that the Ship may be sold at .....

I/We declare that the above power shall not be exercised after the expiration of ..... months from the date hereof.  
 Dated this ..... day of ..... 20.....

IN THE PRESENCE OF  ..... <i>Signature</i> ..... <i>Name (Please Print)</i> ..... <i>Address</i> .....	}	INDIVIDUAL(S) ..... <i>Signature(s)</i> CORPORATION ..... <i>Signature</i> Per .....
--	---	--

**NOTES**— If there are any Mortgages, this application must be accompanied by the written consent of each Mortgagee.  
 If the Owner or Mortgagee is a Corporation, the application or consent should be made by an officer of the Corporation authorised for the purpose and under the Seal of the Corporation.

\*Delete as applicable.

**FORM NO. R 14**

REPUBLIC OF  
TRINIDAD AND TOBAGO

**CERTIFICATE OF SALE**

OFFICIAL NUMBER	NAME OF SHIP	No.	YEAR	PORT OF REGISTRY

PARTICULARS OF SHIP

<b>Propulsion</b> <input type="checkbox"/> None <input type="checkbox"/> Sail <input type="checkbox"/> Auxiliary <input type="checkbox"/> Motor <input type="checkbox"/> Steam <input type="checkbox"/> Other (Specify)				
No. of Screws/Paddles, etc.		If sail, how rigged		
<b>Main Dimensions</b>				
	Feet	Inches	Metres	Centimetres
LENGTH (Specify)...				
.....				
MAXIMUM BREADTH TO OUTSIDE OF HULL ...				
DEPTH IN HOLD FROM TONNAGE DECK TO CEILING/TANK TOP AMIDSHIPS...				
DEPTH FROM TOP OF UPPER DECK AT SIDE AMIDSHIPS TO BOTTOM OF KEEL				
LENGTH OF ENGINE ROOM (IF ANY) ...				

<b>TONNAGE</b>					
	Tons	Cu. Metres		Tons	Cu. Metres
Gross Tonnage ...			*Net/Register Tonnage		

	Tons	Cu. Metres
Deductions on account of space required for propelling power ...		

This ship is assigned with a tonnage mark on each side of the ship which is ..... inches below the upper deck line and when this mark is not submerged the following tonnages are applicable.

Gross ..... tons ..... cu. metres Net ..... tons ..... cu. metres

Year Built	Place Built			Name and Address of Builder		
Type of Ship					Construction Material	
No. of Engines	Description of Engines				Particulars of Boilers	
No. of Shares	NHP	KW or BHP	KW or SHP	Estimated Speed	No.	
Name and Address of Owners			No. of Shares held by each		Amount of Mortgages or Certificates of Mortgage or of Sale in respect of Ship	
*Delete as applicable						

LAWS OF TRINIDAD AND TOBAGO

MINISTRY OF THE ATTORNEY GENERAL AND LEGAL AFFAIRS

www.legalaffairs.gov.tt

270

Chap. 50:10

Shipping

[Subsidiary]

Shipping (Registration of Ships) Regulations

FORM NO. R 14—Continued

The Owner(s) of the Ship described above, appointed .....  
*Full Name*

.....  
*Address*

his/their attorney in his/their name and on his/their behalf to sell the above Ship, and to execute and do all such deeds, matters and things as may be necessary for carrying into effect the power hereby given and declared that the Ship shall not be sold for a sum less than .....and declared that the Ship may be sold at .....

.....

and declared that the above-power shall not be exercised after the expiration of ..... months from the date hereof.

I, the undersigned Registrar of Ships, hereby certify that the above particulars are correct.

Dated at ..... on the ..... day of ..... 20.....

.....  
*Signature*
.....  
*Port of Registry*

.....  
*Name (Please Print)*

**ENDORSEMENT OF DETAILS OF BILL OF SALE**  
*(This section is to be completed by a Proper Officer, in accordance with the relevant instructions, when the sale has been completed)*

Dated at .....

this ..... day of ..... 20 .....

.....  
*Proper Officer*

UNOFFICIAL VERSION

UPDATED TO 31ST DECEMBER 2016

FORM NO. R 15



REPUBLIC OF  
 TRINIDAD AND TOBAGO

APPLICATION FOR A CERTIFICATE OF MORTGAGE

OFFICIAL NUMBER	NAME OF SHIP	No.	YEAR	PORT OF REGISTRY

PARTICULARS OF SHIP

<b>Propulsion</b>				
<input type="checkbox"/> None <input type="checkbox"/> Sail <input type="checkbox"/> Auxiliary <input type="checkbox"/> Motor <input type="checkbox"/> Steam <input type="checkbox"/> Other (Specify)				
No. of Screws/Paddles, etc.		If sail, how rigged		
<b>Main Dimensions</b>				
LENGTH (Specify)...	...	...	...	...
MAXIMUM BREADTH TO OUTSIDE OF HULL	...	...	...	...
DEPTH IN HOLD FROM TONNAGE DECK TO CEILING/TANK TOP AMIDSHIPS	...	...	...	...
DEPTH FROM TOP OF UPPER DECK AT SIDE AMIDSHIPS TO BOTTOM OF KEEL	...	...	...	...
LENGTH OF ENGINE ROOM (IF ANY)	...	...	...	...

TONNAGE

Gross Tonnage	Tons	Cu. Metres	*Net/Register Tonnage	Tons	Cu. Metres

I/We the undersigned, Owner(s) of ..... shares in the Ship described above, hereby appoint .....

.....  
*Full Name*

.....  
*Address*

my/our attorney in my/our name and on my/our behalf to mortgage the said shares, and to execute and do all such deeds, matters, and things as may be necessary for carrying into effect the power hereby given. I/We declare that the amount of money to be raised by mortgage under this power shall not exceed ..... and that the rate of interest at which the sum is raised shall not exceed .....

I/We declare that the power hereby given may be exercised at .....

I/We declare that the above-power shall not be exercised after the expiration of ..... months from the date hereof.

Dated this ..... day of ..... 20.....

IN THE PRESENCE OF

..... <i>Signature</i> ..... <i>Name (Please print)</i> ..... <i>Address</i> .....	INDIVIDUAL (S)	..... <i>Signature</i> CORPORATION(S) ..... <i>Signature</i> Per .....	
	.....		
	.....		
	.....		

NOTE—If the Owner is a Corporation, the application should be made by an officer of the Corporation authorised for the purpose and under the Seal of the Corporation.

\*Delete as applicable.

**LAWS OF TRINIDAD AND TOBAGO**

MINISTRY OF THE ATTORNEY GENERAL AND LEGAL AFFAIRS

www.legalaffairs.gov.tt

272

**Chap. 50:10**

*Shipping*

**[Subsidiary]**

*Shipping (Registration of Ships) Regulations*

**FORM NO. R 16**

REPUBLIC OF  
TRINIDAD AND TOBAGO

**CERTIFICATE OF MORTGAGE**

OFFICIAL NUMBER	NAME OF SHIP	No.	YEAR	PORT OF REGISTRY

PARTICULARS OF SHIP

<b>Propulsion</b>					
<input type="checkbox"/> None	<input type="checkbox"/> Sail	<input type="checkbox"/> Auxiliary	<input type="checkbox"/> Motor	<input type="checkbox"/> Steam	<input type="checkbox"/> Other (Specify)
No. of Screws/Paddles, etc.			If sail, how rigged		
<b>Main Dimensions</b>					
LENGTH (Specify)...					
MAXIMUM BREADTH TO OUTSIDE OF HULL					
DEPTH IN HOLD FROM TONNAGE DECK TO CEILING/TANK TOP AMIDSHIPS...					
DEPTH FROM TOP OF UPPER DECK AT SIDE AMIDSHIPS TO BOTTOM OF KEEL					
LENGTH OF ENGINE ROOM (IF ANY)					

<b>TONNAGE</b>					
Gross Tonnage		Tons	Cu. Metres	*Net/Register Tonnage	

Deductions on account of space required for propelling power		Tons	Cu. Metres

This ship is assigned with a tonnage mark on each side of the ship which is ..... inches below the upper deck line and when this mark is not submerged the following tonnages are applicable.

Gross ..... tons ..... cu. metres Net ..... tons ..... cu. metres

Year Built	Place Built			Name and Address of Builder	
Type of Ship				Construction Material	
No. of Engines	Description of Engines			Particulars of Boilers	
				Description	
No. of Shares	NHP	KW or BHP	KW or SHF	Estimated Speed	No.
					Loaded Pressure
Name and Address of Owners		No. of Shares held by each		Amount of Mortgages or Certificates of Mortgage or of Sale in respect of Ship	

\*Delete as applicable.  
Maritime Services Division  
Ship Registration

No. R 16  
(Continued over)

UNOFFICIAL VERSION

UPDATED TO 31ST DECEMBER 2016

The Owner(s) of ..... shares in the Ship described above, appointed.....  
.....  
*Full Name*  
.....  
*Address*  
.....

his/their attorney in his/their name and on his/their behalf to mortgage the said shares, and to execute and do all such deeds, matters and things as may be necessary for carrying into effect the power hereby given and declared that the amount of money to be raised by the mortgage under this power shall not exceed .....

and that the rates of interest at which the sum is raised shall not exceed .....

and declared that the power hereby given may be exercised at.....  
.....

and declared that the above power shall not be exercised after the expiration of ..... months from the date hereof.

I, the undersigned Registrar of Ships, hereby certify that the above particulars are correct.

Dated at ..... on the ..... day of ..... 20.....

.....  
*Signature* ..... *Port of Registry*  
.....

.....  
*Name (Please Print)*

ENDORSEMENT OF DETAILS OF MORTGAGE

*(This section is to be completed by a Proper Officer, in accordance with the relevant instructions, when a Mortgage has been given.)*

Dated at ..... on the ..... day of ..... 20 .....

.....  
*Proper Officer*

**FORM NO. R 17**

REPUBLIC OF  
TRINIDAD AND TOBAGO

**DECLARATION OF TRANSMISSION**

OFFICIAL NUMBER	NAME OF SHIP	No.	YEAR	PORT OF REGISTRY

**PARTICULARS OF SHIP**

<b>Propulsion</b>				
<input type="checkbox"/> None <input type="checkbox"/> Sail <input type="checkbox"/> Auxiliary <input type="checkbox"/> Motor <input type="checkbox"/> Steam <input type="checkbox"/> Other (Specify)				
No. of Screws/Paddles, etc.		If sail, how rigged		
<b>Main Dimensions</b>				
	Feet	Inches	Metres	Centimetres
LENGTH (Specify)...				
MAXIMUM BREADTH TO OUTSIDE OF HULL ...				
DEPTH IN HOLD FROM TONNAGE DECK TO CEILING/TANK TOP AMIDSHIPS...				
DEPTH FROM TOP OF UPPER DECK AT SIDE AMIDSHIPS TO BOTTOM OF KEEL				
LENGTH OF ENGINE ROOM (IF ANY) ...				

**TONNAGE**

	Tons	Cu. Metres		Tons	Cu. Metres
Gross Tonnage ...			*Net/Register Tonnage		

I, ..... *Full Name*

of ..... *Address*

Occupation ..... Nationality .....

**DECLARE AS FOLLOWS:**

1. The above general description of the ship is correct.

---

**2. INDIVIDUAL OWNER:**

I am qualified to own a Trinidad and Tobago ship and I am entitled to be registered as

Owner of ..... shares in the above described ship.

or

Joint Owner of ..... shares in the above described ship.

**CORPORATE OWNER:**

I am ..... of the ..... *Name of Corporation*

*Office Held*

incorporated by virtue of ..... *Law under which it was incorporated*

and which has its principal place of business at .....

The said Corporation is entitled to be registered as

Owner of ..... shares in the above described ship.

or

Joint Owner of ..... shares in the above described ship.

\*Delete as applicable.

<p>2A. INDIVIDUAL MORTGAGEE:</p> <p>I am qualified to own a Trinidad and Tobago ship and I am entitled to be registered as</p> <p><input type="checkbox"/> Mortgagee of ..... shares in the above described ship</p> <p>or</p> <p><input type="checkbox"/> Joint Mortgagee of ..... shares in the above described ship</p> <p>CORPORATE MORTGAGEE:</p> <p>I am ..... of the .....</p> <p style="text-align: center;"><i>Office Held</i> <span style="float: right;"><i>Name of Corporation</i></span></p> <p>incorporated by virtue of .....</p> <p style="text-align: center;"><i>Law under which it was incorporated</i></p> <p>and which has its principal place of business at .....</p> <p>The said Corporation is entitled to be registered as</p> <p><input type="checkbox"/> Mortgagee of ..... shares in the above described ship</p> <p>or</p> <p><input type="checkbox"/> Joint Mortgagee of ..... shares in the above described ship</p>	
<p>3. The shares in the above described ship have been transmitted in the following manner:</p> <p><input type="checkbox"/> On Death      <input type="checkbox"/> On Bankruptcy      <input type="checkbox"/> By lawful means other than a Transfer under the Shipping Act, Chap 50:10.</p> <p>(State the details of the manner in which and from whom the property has been transmitted)</p>	
<p>DECLARED BEFORE ME</p> <p>this ..... day of ..... 20 .....</p> <p>.....</p> <p style="text-align: center;"><i>Signature</i></p> <p>.....</p> <p style="text-align: center;"><i>Name (Please Print)</i></p> <p>.....</p> <p style="text-align: center;"><i>Address</i></p> <p>.....</p>	<p>INDIVIDUAL</p> <p>.....</p> <p style="text-align: center;"><i>Signature</i></p> <p>CORPORATION</p> <p>.....</p> <p style="text-align: center;"><i>Signature</i></p> <div style="text-align: center; border: 1px solid black; border-radius: 50%; width: 60px; height: 60px; margin: 0 auto; display: flex; align-items: center; justify-content: center;"><p>SEAL</p></div>

NOTES:

- 1— Qualifications to own a ship registered in Trinidad and Tobago are set out in section 4 of the Shipping Act, Chap. 50:10.
- 2— Declarations shall be made before a Registrar or Justice of the Peace, or a Commissioner for Oaths, or a Consular Officer or before any person authorised by law to administer oaths.
- 3— Declarations may be made on behalf of a corporation by an officer of the corporation authorised by it for the purpose. Such authorisation may be evidenced by the affixing of the Seal of the corporation to this declaration or a document in writing executed by the corporation under its Seal in which the declarant is authorised to sign on its behalf.
- 4— In the case of death this Declaration of Transmission must be accompanied by a certified copy of the Death or Burial Certificate and a certified copy of the Will or Letters of Administration.
- 5— In the case of bankruptcy *et cetera* this Declaration of Transmission must be accompanied by a certified copy of the instrument appointing the Trustee or Receiver.

**LAWS OF TRINIDAD AND TOBAGO**

MINISTRY OF THE ATTORNEY GENERAL AND LEGAL AFFAIRS

www.legalaffairs.gov.tt

276

**Chap. 50:10**

*Shipping*

[Subsidiary]

*Shipping (Registration of Ships) Regulations*

**FORM NO. R 18**

REPUBLIC OF  
TRINIDAD AND TOBAGO

**DECLARATION**

**CERTIFICATE OF REGISTRY**

**To obtain (1) a Duplicate COLR or (2) a Provisional Certificate of Registry to replace a Certificate that has been lost, misplaced or destroyed.**

OFFICIAL NUMBER	NAME OF SHIP	No.	YEAR	PORT OF REGISTRY

PARTICULARS OF SHIP

<b>Propulsion</b>				
<input type="checkbox"/> None <input type="checkbox"/> Sail <input type="checkbox"/> Auxiliary <input type="checkbox"/> Motor <input type="checkbox"/> Steam <input type="checkbox"/> Other (Specify)				
No. of Screws/Paddles, etc.		If sail, how rigged		
<b>Main Dimensions</b>		Feet	Inches	Metres
LENGTH (Specify)...				
MAXIMUM BREADTH TO OUTSIDE OF HULL				
DEPTH IN HOLD FROM TONNAGE DECK TO CEILING/TANK TOP AMIDSHIPS				
DEPTH FROM TOP OF UPPER DECK AT SIDE AMIDSHIPS TO BOTTOM OF KEEL				
LENGTH OF ENGINE ROOM (IF ANY)				

NO. OF DECKS	NO. OF MASTS	NO. OF BULKHEADS	STEM	STERN
WHERE BUILT		DATE BUILT	NAME AND ADDRESS OF BUILDER	
TYPE OF SHIP	CONSTRUCTION MATERIAL			

PARTICULARS OF TONNAGE

The tonnages of this ship, in accordance with its International or Trinidad and Tobago Tonnage Certificate are:	
Delete if not applicable	GROSS TONNAGE .....tons ( .....cubic metres)
	NET/REGISTER TONNAGE .....tons ( .....cubic metres)
	This ship is assigned with a tonnage mark on each side of the ship which is ..... inches below the upper deck line and when this mark is submerged the above tonnages are applicable. When the tonnage mark is NOT submerged the following tonnages are applicable:
	GROSS TONNAGE .....tons ( .....cubic metres)
NET/REGISTER TONNAGE .....tons ( .....cubic metres)	
A detailed summary of the tonnages for the ship is shown on its International or Trinidad and Tobago Certificate.	

PARTICULARS OF PROPELLING ENGINES, ETC.

No. of Engines	Type of Engines	Power		Boilers	
		KW		No.	
No. of Shafts	Name and Address of Maker	N.H.P.		Type	
		B.H.P.		Load Pressure	
Date made		I.H.P.		Date made	
		Estd. Spd.			

Maritime Services Division  
Ship Registration

No. R 18  
(Continued over)

UNOFFICIAL VERSION

UPDATED TO 31ST DECEMBER 2016

*Shipping*

**Chap. 50:10**

277

*Shipping (Registration of Ships) Regulations*

**[Subsidiary]**

The number of seamen and apprentices for whom accommodation is certified .....

NAME OF MASTER	NO. OF CERTIFICATE OF COMPETENCY OR SERVICE		
I, the undersigned, declare that, to the best of my knowledge and belief, the above particulars are correct. The Certificate of Registry of the ship described above has been <input type="checkbox"/> lost <input type="checkbox"/> misplaced <input type="checkbox"/> destroyed under the following circumstances: ..... .....			
The registered owners of the ship are as follows:			
Full Name	Address	Occupation	No. of Shares
Dated at ..... on the ..... day of ..... 20.....			
IN THE PRESENCE OF  ..... <i>Signature</i>  ..... <i>Name (Please Print)</i>  ..... <i>Address</i>  .....	}	INDIVIDUAL  ..... <i>Signature</i>  CORPORATION  ..... <i>Signature</i>	}
			

Maritime Services Division  
 Ship Registration

**LAWS OF TRINIDAD AND TOBAGO**

MINISTRY OF THE ATTORNEY GENERAL AND LEGAL AFFAIRS

www.legalaffairs.gov.tt

278

**Chap. 50:10**

*Shipping*

[Subsidiary]

*Shipping (Registration of Ships) Regulations*

**FORM NO. R 18—T**

REPUBLIC OF  
TRINIDAD AND TOBAGO

**DECLARATION**

(Tug)

**To obtain (1) a Duplicate Certificate of Registry or (2) a Provisional Certificate of Registry to replace a Certificate that has been lost, misplaced or destroyed.**

OFFICIAL NUMBER	NAME OF SHIP	No.	YEAR	PORT OF REGISTRY

PARTICULARS OF SHIP

<b>Propulsion</b>				
<input type="checkbox"/> None <input type="checkbox"/> Sail <input type="checkbox"/> Auxiliary <input type="checkbox"/> Motor <input type="checkbox"/> Steam <input type="checkbox"/> Other (Specify)				
No. of Screws/Paddles, etc.			If sail, how rigged	
<b>Main Dimensions</b>			Feet	Inches
LENGTH (Specify).....				
.....				
MAXIMUM BREADTH TO OUTSIDE OF HULL .....				
DEPTH IN HOLD FROM TONNAGE DECK TO CEILING/TANK TOP AMIDSHIPS.....				
DEPTH FROM TOP OF UPPER DECK AT SIDE AMIDSHIPS TO BOTTOM OF KEEL.....				
LENGTH OF ENGINE ROOM (IF ANY) .....				

NO. OF DECKS	NO. OF MASTS	NO. OF BULKHEADS	STEM	STERN
WHERE BUILT		DATE BUILT	NAME AND ADDRESS OF BUILDER	
			.....	
TYPE OF SHIP	CONSTRUCTION MATERIAL			
	.....			

PARTICULARS OF TONNAGE

The tonnages of this ship, in accordance with its International or Trinidad and Tobago Tonnage Certificate are:	
GROSS TONNAGE .....	tons ( .....cubic metres)
NET/REGISTER TONNAGE .....	tons ( .....cubic metres)
If and when employed for the carriage of passengers, cargo or stores, or using graving docks or dry docks or places provided for the repairing of vessels, the register tonnage on which dues based on register tonnage may be levied by any harbour or dock authority is ..... tons.	
A detailed summary of the tonnages for the ship is shown on its International or Trinidad and Tobago Tonnage Certificate.	

PARTICULARS OF PROPELLING ENGINES, ETC.

No. of Engines	Type of Engines	Power		Boilers	
		KW		No.	
No. of Shafts	Name and Address of Maker	N.H.P.		Type	
		B.H.P.		Load Pressure	
Date made		I.H.P.		Date made	
		Estd. Spd.			

No. R 18—T  
(Continued over)

UNOFFICIAL VERSION

UPDATED TO 31ST DECEMBER 2016

The number of seamen and apprentices for whom accommodation is certified .....

NAME OF MASTER	NO. OF CERTIFICATE OF COMPETENCY OR SERVICE		
I, the undersigned, declare that, to the best of my knowledge and belief, the above particulars are correct. The Certificate of Registry of the ship described above has been <input type="checkbox"/> lost <input type="checkbox"/> misplaced <input type="checkbox"/> destroyed under the following circumstances: ..... .....			
The registered owners of the ship are as follows:			
Full Name	Address	Occupation	No. of Shares
Dated at ..... on the ..... day of ..... 20.....			
IN THE PRESENCE OF  ..... <i>Signature</i>  ..... <i>Name (Please Print)</i>  ..... <i>Address</i>  .....	}  }  }	INDIVIDUAL  ..... <i>Signature</i>  CORPORATION  ..... <i>Signature</i>	

Maritime Services Division  
 Ship Registration

**LAWS OF TRINIDAD AND TOBAGO**

MINISTRY OF THE ATTORNEY GENERAL AND LEGAL AFFAIRS

www.legalaffairs.gov.tt

280

**Chap. 50:10**

*Shipping*

**[Subsidiary]**

*Shipping (Registration of Ships) Regulations*

**FORM NO. R 19**

REPUBLIC OF  
TRINIDAD AND TOBAGO

**PROVISIONAL CERTIFICATE OF REGISTRY**

**(To temporarily replace a Certificate of Registry  
that has been lost, misplaced or destroyed)**

OFFICIAL NUMBER	NAME OF SHIP	No.	YEAR	PORT OF REGISTRY

PARTICULARS OF SHIP

<b>Propulsion</b>				
<input type="checkbox"/> None <input type="checkbox"/> Sail <input type="checkbox"/> Auxiliary <input type="checkbox"/> Motor <input type="checkbox"/> Steam <input type="checkbox"/> Other (Specify)				
No. of Screws/Paddles, etc.		If sail, how rigged		
<b>Main Dimensions</b>				
		Feet	Inches	Metres
LENGTH (Specify)...	.....			
MAXIMUM BREADTH TO OUTSIDE OF HULL	.....			
DEPTH IN HOLD FROM TONNAGE DECK TO CEILING/TANK TOP AMIDSHIPS...	.....			
DEPTH FROM TOP OF UPPER DECK AT SIDE AMIDSHIPS TO BOTTOM OF KEEL	.....			
LENGTH OF ENGINE ROOM (IF ANY)	.....			
NO. OF DECKS	NO. OF MASTS	NO. OF BULKHEADS	STEM	STERN
WHERE BUILT	DATE BUILT	NAME AND ADDRESS OF BUILDER		
TYPE OF SHIP	CONSTRUCTION MATERIAL	.....		
		.....		

PARTICULARS OF TONNAGE

The tonnages of this ship, in accordance with its International or Trinidad and Tobago Tonnage Certificate are:	
	GROSS TONNAGE.....tons    ( .....cubic metres)
	NET/REGISTER TONNAGE .....tons    ( .....cubic metres)
Delete if not applicable	This ship is assigned with a tonnage mark on each side of the ship which is ..... inches below the upper deck line and when this mark is submerged the above tonnages are applicable. When the tonnage mark is NOT submerged the following tonnages are applicable:
	GROSS TONNAGE.....tons    ( .....cubic metres)
	NET/REGISTER TONNAGE .....tons    ( .....cubic metres)
A detailed summary of the tonnages for the ship is shown on its International or Trinidad and Tobago Tonnage Certificate.	

Maritime Services Division  
Ship Registration

No. R 19  
(Continued over)

UNOFFICIAL VERSION

UPDATED TO 31ST DECEMBER 2016

*Shipping*

**Chap. 50:10**

281

*Shipping (Registration of Ships) Regulations*

**[Subsidiary]**

PARTICULARS OF PROPELLING ENGINES, ETC.

No. of Engines	Type of Engines	Power		Boilers	
		KW		No.	
No. of Shafts	Name and Address of Maker	N.H.P.		Type	
Date made		B.H.P.		Load Pressure	
		I.H.P.		Date made	
		Estd. Spd.			

The number of seamen and apprentices for whom accommodation is certified .....

NAME OF MASTER	NO. OF CERTIFICATE OF COMPETENCY OR SERVICE		
The registered owners of the ship are as follows:			
Full Name	Address	Occupation	No. of Shares

I, the undersigned ..... (Proper Officer) at ..... hereby issue this Certificate in accordance with section 31 of the Shipping Act, Chap. 50:10 and the Regulations made thereunder.

Dated at ..... the ..... day of ..... 20.....

NOTE: This Provisional Certificate of Registry must, within ten days after the first subsequent arrival of the ship at a port in Trinidad and Tobago, or within six months of the date of issue of this certificate, whichever is the sooner, be delivered up by the Master to the Registrar at its port of Registry in accordance with regulation 32(4) of the Shipping (Registration of Ships) Regulations. Penalty for contravention shall be in accordance with regulation 41 of the said Regulations.

.....  
*Proper Officer*

\_\_\_\_\_

**FORM NO. R 19—T**



REPUBLIC OF  
TRINIDAD AND TOBAGO

**PROVISIONAL CERTIFICATE OF REGISTRY**

(Tug)

(To temporarily replace a Certificate of Registry  
that has been lost, misplaced or destroyed)

OFFICIAL NUMBER	NAME OF SHIP	No.	YEAR	PORT OF REGISTRY

PARTICULARS OF SHIP

<b>Propulsion</b>				
<input type="checkbox"/> None <input type="checkbox"/> Sail <input type="checkbox"/> Auxiliary <input type="checkbox"/> Motor <input type="checkbox"/> Steam <input type="checkbox"/> Other (Specify)				
No. of Screws/Paddles, etc.		If sail, how rigged		
<b>Main Dimensions</b>				
LENGTH (Specify)...	Feet	Inches	Metres	Centimetres
.....				
MAXIMUM BREADTH TO OUTSIDE OF HULL				
DEPTH IN HOLD FROM TONNAGE DECK TO CEILING/TANK TOP AMIDSHIPS...				
DEPTH FROM TOP OF UPPER DECK AT SIDE AMIDSHIPS TO BOTTOM OF KEEL				
LENGTH OF ENGINE ROOM (IF ANY)				
NO. OF DECKS	NO. OF MASTS	NO. OF BULKHEADS	STEM	STERN
WHERE BUILT		DATE BUILT	NAME AND ADDRESS OF BUILDER	
			.....	
TYPE OF SHIP	CONSTRUCTION MATERIAL		.....	
			.....	

PARTICULARS OF TONNAGE

The tonnages of this ship, in accordance with its International or Trinidad and Tobago Tonnage Certificate are:	
GROSS TONNAGE .....	tons ( .....cubic metres)
NET/REGISTER TONNAGE .....	tons ( .....cubic metres)
If and when employed for the carriage of passengers, cargo or stores, or using graving docks or dry docks or places provided for the repairing of vessels, the register tonnage on which dues based on register tonnage may be levied by any harbour or dock authority is ..... tons.	
A detailed summary of the tonnages for the ship is shown on its International or Trinidad and Tobago Tonnage Certificate.	

*Shipping*

**Chap. 50:10**

283

*Shipping (Registration of Ships) Regulations*

**[Subsidiary]**

PARTICULARS OF PROPELLING ENGINES, ETC.

No. of Engines	Type of Engines	Power		Boilers	
		KW		No.	
No. of Shafts	Name and Address of Maker	N.H.P.		Type	
		B.H.P.		Load Pressure	
Date made		I.H.P.		Date made	
		Estd. Spd.			

The number of seamen and apprentices for whom accommodation is certified .....

NAME OF MASTER	NO. OF CERTIFICATE OF COMPETENCY OR SERVICE		
The registered owners of the ship are as follows:			
Full Name	Address	Occupation	No. of Shares

I, the undersigned ..... (Proper Officer) at ..... hereby issue this Certificate in accordance with section 31 of the Shipping Act, Chap. 50:10 and the Regulations made thereunder.

Dated at ..... the ..... day of ..... 20.....

Note: This Provisional Certificate of Registry must, within ten days after the first subsequent arrival of the ship at a port in Trinidad and Tobago, or within six months of the date of issue of this certificate, whichever is the sooner, be delivered up by the Master to the Registrar at its port of Registry in accordance with regulation 32(4) of the Shipping (Registration of Ships) Regulations. Penalty for contravention shall be in accordance with regulation 41 of the said Regulations.

.....  
*Proper Officer*

\_\_\_\_\_

**LAWS OF TRINIDAD AND TOBAGO**

MINISTRY OF THE ATTORNEY GENERAL AND LEGAL AFFAIRS

www.legalaffairs.gov.tt

284

**Chap. 50:10**

*Shipping*

[Subsidiary]

*Shipping (Registration of Ships) Regulations*

**FORM NO. R 20**

REPUBLIC OF  
TRINIDAD AND TOBAGO

**DECLARATION**

**To obtain a Provisional Certificate of Registry for an unregistered Ship**

OFFICIAL NUMBER	NAME OF SHIP	No.	YEAR	PORT OF REGISTRY

PARTICULARS OF SHIP

<b>Propulsion</b>				
<input type="checkbox"/> None <input type="checkbox"/> Sail <input type="checkbox"/> Auxiliary <input type="checkbox"/> Motor <input type="checkbox"/> Steam <input type="checkbox"/> Other (Specify)				
No. of Screws/Paddles, etc.		If sail, how rigged		
<b>Main Dimensions</b>				
LENGTH (Specify)...	Feet	Inches	Metres	Centimetres
.....				
MAXIMUM BREADTH TO OUTSIDE OF HULL .....				
DEPTH IN HOLD FROM TONNAGE DECK TO CEILING/TANK TOP AMIDSHIPS...				
DEPTH FROM TOP OF UPPER DECK AT SIDE AMIDSHIPS TO BOTTOM OF KEEL				
LENGTH OF ENGINE ROOM (IF ANY) .....				
NO. OF DECKS	NO. OF MASTS	NO. OF BULKHEADS	STEM	STERN
WHERE BUILT		DATE BUILT	NAME AND ADDRESS OF BUILDER	
TYPE OF SHIP	CONSTRUCTION MATERIAL			

PARTICULARS OF TONNAGE

The tonnages of this ship, in accordance with its International or Trinidad and Tobago Tonnage Certificate are:		
GROSS TONNAGE .....	tons ( .....cubic metres)	
NET/REGISTER TONNAGE .....	tons ( .....cubic metres)	
Delete if not applicable	This ship is assigned with a tonnage mark on each side of the ship which is ..... inches below the upper deck line and when this mark is submerged the above tonnages are applicable. When the tonnage mark is NOT submerged the following tonnages are applicable:	
	GROSS TONNAGE .....	tons ( .....cubic metres)
	NET/REGISTER TONNAGE .....	tons ( .....cubic metres)
	A detailed summary of the tonnages for the ship is shown on its International or Trinidad and Tobago Tonnage Certificate.	

PARTICULARS OF PROPELLING ENGINES, ETC.

No. of Engines	Type of Engines	Power		Boilers	
		KW		No.	
No. of Shafts	Name and Address of Maker	N.H.P.		Type	
		B.H.P.		Load Pressure	
Date made		I.H.P.		Date made	
		Estd. Spd.			

Maritime Services Division  
Ship Registration

No. R 20  
(Continued over)

UNOFFICIAL VERSION

UPDATED TO 31ST DECEMBER 2016

*Shipping*

**Chap. 50:10**

285

*Shipping (Registration of Ships) Regulations*

**[Subsidiary]**

The number of seamen and apprentices for whom accommodation is certified .....	
NAME OF MASTER	NO. OF CERTIFICATE OF COMPETENCY OR SERVICE
I, ..... <i>Full Name</i> of ..... <i>Address</i> Occupation ..... Nationality .....	
DECLARE AS FOLLOWS: 1. The above particulars respecting the ship are the best that I am able to obtain.	

2. INDIVIDUAL: I am qualified to own a Trinidad and Tobago ship and I am entitled to be registered as <input type="checkbox"/> Owner of ..... shares or <input type="checkbox"/> Joint Owner of ..... shares with those whose names as listed: CORPORATION: I am ..... <i>Office Held</i> ..... <i>Name of Corporation</i> Incorporated by virtue of ..... <i>Law under which it was incorporated</i> and which has its principal place of business at ..... The said Corporation is entitled to be registered as <input type="checkbox"/> Owner of ..... shares or <input type="checkbox"/> Joint Owner of ..... shares with those whose names are listed.	
---	--

List of remaining joint owners (If applicable)		
Full Name	Address	Occupation

3. To the best of my knowledge and belief no unqualified person or body of persons is entitled as owner to any legal or beneficial interest in the ship or any share therein.	
DECLARED BEFORE ME this ..... day of ..... 20 ..... ..... <i>Signature</i> ..... <i>Name (Please Print)</i> ..... <i>Address</i> .....	INDIVIDUAL ..... <i>Signature</i> CORPORATION ..... <i>Signature</i>
	

- NOTES:
- 1— Qualifications to own a ship registered in Trinidad and Tobago are set out in section 4 of the Shipping Act, Chap. 50:10.
  - 2— Declarations shall be made before a Registrar or Justice of the Peace, or a Commissioner for Oaths, or a Consular Officer or before any person authorised by law to administer oaths.
  - 3— Declarations may be made on behalf of a corporation by an officer of the corporation authorised by it for the purpose. Such authorisation may be evidenced by the affixing of the Seal of the corporation to this declaration or a document in writing executed by the corporation under its Seal in which the declarant is authorised to sign on its behalf.

**LAWS OF TRINIDAD AND TOBAGO**

MINISTRY OF THE ATTORNEY GENERAL AND LEGAL AFFAIRS

www.legalaffairs.gov.tt

286

**Chap. 50:10**

*Shipping*

[Subsidiary]

*Shipping (Registration of Ships) Regulations*

**FORM NO. R 20—T**

REPUBLIC OF  
TRINIDAD AND TOBAGO

**DECLARATION**

(Tug)

**To obtain a Provisional Certificate of Registry for an unregistered Ship**

OFFICIAL NUMBER	NAME OF SHIP	No.	YEAR	PORT OF REGISTRY

PARTICULARS OF SHIP

<b>Propulsion</b>				
<input type="checkbox"/> None <input type="checkbox"/> Sail <input type="checkbox"/> Auxiliary <input type="checkbox"/> Motor <input type="checkbox"/> Steam <input type="checkbox"/> Other (Specify)				
No. of Screws/Paddles, etc.			If sail, how rigged	
<b>Main Dimensions</b>				
LENGTH (Specify)...	Feet	Inches	Metres	Centimetres
.....				
MAXIMUM BREADTH TO OUTSIDE OF HULL				
DEPTH IN HOLD FROM TONNAGE DECK TO CEILING/TANK TOP AMIDSHIPS...				
DEPTH FROM TOP OF UPPER DECK AT SIDE AMIDSHIPS TO BOTTOM OF KEEL				
LENGTH OF ENGINE ROOM (IF ANY)				
NO. OF DECKS	NO. OF MASTS	NO. OF BULKHEADS	STEM	STERN
WHERE BUILT		DATE BUILT	NAME AND ADDRESS OF BUILDER	
TYPE OF SHIP	CONSTRUCTION MATERIAL			

PARTICULARS OF TONNAGE

<p>The tonnages of this ship, in accordance with its International or Trinidad and Tobago Tonnage Certificate are:</p> <p>GROSS TONNAGE .....tons    ( .....cubic metres)</p> <p>NET/REGISTER TONNAGE .....tons    ( .....cubic metres)</p> <p>If and when employed for the carriage of passengers, cargo or stores, or using graving docks or dry docks or places provided for the repairing of vessels, the register tonnage on which dues based on register tonnage may be levied by any harbour or dock authority is ..... tons.</p> <p>A detailed summary of the tonnages for the ship is shown on its International or Trinidad and Tobago Tonnage Certificate.</p>
---

PARTICULARS OF PROPELLING ENGINES, ETC.

No. of Engines	Type of Engines	Power		Boilers	
		KW		No.	
No. of Shafts	Name and Address of Maker	N.H.P.		Type	
		B.H.P.		Load Pressure	
Date made		I.H.P.		Date made	
		Estd. Spd.			

Maritime Services Division  
Ship Registration

No. R 20—T  
(Continued over)

UNOFFICIAL VERSION

UPDATED TO 31ST DECEMBER 2016

The number of seamen and apprentices for whom accommodation is certified .....		
NAME OF MASTER	NO. OF CERTIFICATE OF COMPETENCY OR SERVICE	
I, ..... <i>Full Name</i> of ..... <i>Address</i> Occupation ..... Nationality .....		
DECLARE AS FOLLOWS: 1. The above particulars respecting the ship are the best that I am able to obtain.		
2. INDIVIDUAL: I am qualified to own a Trinidad and Tobago ship and I am entitled to be registered as <input type="checkbox"/> Owner of ..... shares or <input type="checkbox"/> Joint Owner of ..... shares with those whose names are listed: CORPORATION: I am ..... <i>Office Held</i> ..... <i>Name of Corporation</i> Incorporated by virtue of ..... <i>Law under which it was incorporated</i> and which has its principal place of business at ..... The said Corporation is entitled to be registered as <input type="checkbox"/> Owner of ..... shares or <input type="checkbox"/> Joint Owner of ..... shares with those whose names are listed.		
List of remaining joint owners ( <i>If applicable</i> )		
Full Name	Address	Occupation
3. To the best of my knowledge and belief no unqualified person or body of persons is entitled as owner to any legal or beneficial interest in the ship or any share therein. DECLARED BEFORE ME this ..... day of ..... 20 ..... ..... <i>Signature</i> ..... <i>Name (Please Print)</i> ..... <i>Address</i> .....		
INDIVIDUAL ..... <i>Signature</i>		
CORPORATION ..... <i>Signature</i>		

NOTES:

- 1— Qualifications to own a ship registered in Trinidad and Tobago are set out in section 4 of the Shipping Act, Chap. 50:10.
- 2— Declarations shall be made before a Registrar or Justice of the Peace, or a Commissioner for Oaths, or a Consular Officer or before any person authorised by law to administer oaths.
- 3— Declarations may be made on behalf of a corporation by an officer of the corporation authorised by it for the purpose. Such authorisation may be evidenced by the affixing of the Seal of the corporation to this declaration or a document in writing executed by the corporation under its Seal in which the declarant is authorised to sign on its behalf.

**FORM NO. R 21**

REPUBLIC OF  
TRINIDAD AND TOBAGO

**PROVISIONAL CERTIFICATE OF REGISTRY**  
(for an unregistered ship)

OFFICIAL NUMBER	NAME OF SHIP	No.	YEAR	PORT OF REGISTRY

PARTICULARS OF SHIP

<b>Propulsion</b>				
<input type="checkbox"/> None <input type="checkbox"/> Sail <input type="checkbox"/> Auxiliary <input type="checkbox"/> Motor <input type="checkbox"/> Steam <input type="checkbox"/> Other (Specify)				
No. of Screws/Paddles, etc.			If sail, how rigged	
<b>Main Dimensions</b>				
LENGTH (Specify).....	Feet	Inches	Metres	Centimetres
.....				
MAXIMUM BREADTH TO OUTSIDE OF HULL .....				
DEPTH IN HOLD FROM TONNAGE DECK TO CEILING/TANK TOP AMIDSHIPS.....				
DEPTH FROM TOP OF UPPER DECK AT SIDE AMIDSHIPS TO BOTTOM OF KEEL				
LENGTH OF ENGINE ROOM (IF ANY) .....				
NO. OF DECKS	NO. OF MASTS	NO. OF BULKHEADS	STEM	STERN
WHERE BUILT		DATE BUILT	NAME AND ADDRESS OF BUILDER	
TYPE OF SHIP	CONSTRUCTION MATERIAL			

PARTICULARS OF TONNAGE

Delete if not applicable	The tonnages of this ship, in accordance with its International or Trinidad and Tobago Tonnage Certificate are:  GROSS TONNAGE .....tons    ( .....cubic metres)  NET/REGISTER TONNAGE .....tons    ( .....cubic metres)  This ship is assigned with a tonnage mark on each side of the ship which is ..... inches below the upper deck line and when this mark is submerged the above tonnages are applicable. When the tonnage mark is NOT submerged the following tonnages are applicable:  GROSS TONNAGE .....tons    ( .....cubic metres)  NET/REGISTER TONNAGE .....tons    ( .....cubic metres)  A detailed summary of the tonnages for the ship is shown on its International or Trinidad and Tobago Tonnage Certificate.
--------------------------	---

PARTICULARS OF PROPELLING ENGINES, ETC.

No. of Engines	Type of Engines	Power		Boilers	
		KW		No.	
No. of Shafts	Name and Address of Maker	N.H.P.		Type	
		B.H.P.		Load Pressure	
Date made		I.H.P.		Date made	
		Estd. Spd.			

The number of seamen and apprentices for whom accommodation is certified .....
The persons whose names appear below purchased, on the ..... day of ..... 20....., all the shares in the above ship: ..... ..... .....
I, the undersigned ..... Proper Officer at ..... hereby certify that: 1. The description of the ship and the details of its purchase are true. 2. That ..... of ..... ..... whose Certificate of Competency or Service is No. .... is Master. 3. The foreign name of the ship is .....
Dated at ..... the ..... day of ..... 20.....
Note: This Provisional Certificate of Registry, issued under the provisions of section 32 of the Shipping Act, Chap. 50:10 continues in force only until the ..... day of ..... 20....., OR until the Ship's arrival at a port in Trinidad and Tobago WHICHEVER FIRST HAPPENS.

If the ship has not been surveyed for the purpose, the Proper Officer must insert the description as fully and accurately as he can, stating how he has procured the description.

\_\_\_\_\_

**LAWS OF TRINIDAD AND TOBAGO**

MINISTRY OF THE ATTORNEY GENERAL AND LEGAL AFFAIRS

www.legalaffairs.gov.tt

290

**Chap. 50:10**

*Shipping*

[Subsidiary]

*Shipping (Registration of Ships) Regulations*

**FORM NO. R 21—T**

REPUBLIC OF  
TRINIDAD AND TOBAGO

**PROVISIONAL CERTIFICATE OF REGISTRY**

(Tug)

(for an unregistered ship)

OFFICIAL NUMBER	NAME OF SHIP	No.	YEAR	PORT OF REGISTRY

PARTICULARS OF SHIP

<b>Propulsion</b>							
<input type="checkbox"/> None <input type="checkbox"/> Sail <input type="checkbox"/> Auxiliary <input type="checkbox"/> Motor <input type="checkbox"/> Steam <input type="checkbox"/> Other (Specify)							
No. of Screws/Paddles, etc.			If sail, how rigged				
<b>Main Dimensions</b>				Feet	Inches	Metres	Centimetres
LENGTH (Specify).....							
MAXIMUM BREADTH TO OUTSIDE OF HULL .....							
DEPTH IN HOLD FROM TONNAGE DECK TO CEILING/TANK TOP AMIDSHIPS...							
DEPTH FROM TOP OF UPPER DECK AT SIDE AMIDSHIPS TO BOTTOM OF KEEL							
LENGTH OF ENGINE ROOM (IF ANY) .....							
NO. OF DECKS	NO. OF MASTS	NO. OF BULKHEADS	STEM	STERN			
WHERE BUILT		DATE BUILT	NAME AND ADDRESS OF BUILDER				
TYPE OF SHIP		CONSTRUCTION MATERIAL					

PARTICULARS OF TONNAGE

<p>The tonnages of this ship, in accordance with its International or Trinidad and Tobago Tonnage Certificate are:</p> <p>GROSS TONNAGE .....tons    ( .....cubic metres)</p> <p>NET/REGISTER TONNAGE .....tons    ( .....cubic metres)</p> <p>If and when employed for the carriage of passengers, cargo or stores, or using graving docks or dry docks or places provided for the repairing of vessels, the register tonnage on which dues based on register tonnage may be levied by any harbour or dock authority is ..... tons.</p> <p>A detailed summary of the tonnages for the ship is shown on its International or Trinidad and Tobago Tonnage Certificate.</p>
---

PARTICULARS OF PROPELLING ENGINES, ETC.

No. of Engines	Type of Engines	Power		Boilers	
		KW	I.H.P.	No.	Type
No. of Shafts	Name and Address of Maker	B.H.P.		Load Pressure	
		I.H.P.	I.H.P.	Date made	
Date made		Estd. Spd.			

Maritime Services Division  
Ship Registration

No. R 21—T  
(Continued over)

UNOFFICIAL VERSION

UPDATED TO 31ST DECEMBER 2016

The number of seamen and apprentices for whom accommodation is certified .....
The persons whose names appear below purchased, on the ..... day of ..... 20....., all the shares in the above ship: ..... ..... .....
I, the undersigned .....
Proper Officer at .....
hereby certify that:
1. The description of the ship and the details of its purchase are true.
2. That .....
of .....
.....
whose Certificate of Competency or Service is No. .... is Master.
3. The foreign name of the ship is .....
Dated at ..... the ..... day of ..... 20.....
Note: This Provisional Certificate of Registry, issued under the provisions of section 32 of the Shipping Act, Chap. 50:10 continues in force only until the ..... day of ..... 20....., OR until the Ship's arrival at a port in Trinidad and Tobago WHICHEVER FIRST HAPPENS .

If the ship has not been surveyed for the purpose, the Proper Officer must insert the description as fully and accurately as he can, stating how he has procured the description.

\_\_\_\_\_

**LAWS OF TRINIDAD AND TOBAGO**

MINISTRY OF THE ATTORNEY GENERAL AND LEGAL AFFAIRS

www.legalaffairs.gov.tt

292

**Chap. 50:10**

*Shipping*

[Subsidiary]

*Shipping (Registration of Ships) Regulations*

**FORM NO. R 22**

REPUBLIC OF

TRINIDAD AND TOBAGO

**APPLICATION FOR PERMISSION TO PASS  
(for an unregistered ship)**

BUILDER'S IDENTIFICATION	NAME OF SHIP	INTENDED PORT OF REGISTRY
--------------------------	--------------	---------------------------

**PARTICULARS OF SHIP**

<b>Propulsion</b>				
<input type="checkbox"/> None <input type="checkbox"/> Sail <input type="checkbox"/> Auxiliary <input type="checkbox"/> Motor <input type="checkbox"/> Steam <input type="checkbox"/> Other (Specify)				
No. of Screws/Paddles, etc.			If sail, how rigged	
<b>Main Dimensions</b>			Feet	Inches
LENGTH (Specify)...				
.....				
MAXIMUM BREADTH TO OUTSIDE OF HULL				
DEPTH IN HOLD FROM TONNAGE DECK TO CEILING/TANK TOP AMIDSHIPS...				
DEPTH FROM TOP OF UPPER DECK AT SIDE AMIDSHIPS TO BOTTOM OF KEEL				
LENGTH OF ENGINE ROOM (IF ANY)				

<b>TONNAGE</b>				
	Tons	Cu. Metres		Tons
Gross Tonnage	...		*Net/Register Tonnage	

TYPE OF SHIP		CONSTRUCTION MATERIAL
--------------	--	-----------------------

**DETAILS OF APPLICANT**

Full Name	Address	Telephone Number	Telex Number

**DETAILS OF OWNERS**

Full Name	Address	Occupation	No. of Shares

**DETAILS OF PROPOSED VOYAGE**

Application is made for the unregistered ship .....
to pass from ..... to .....
The voyage will commence on or after ..... and end on or before .....

**PROPOSED LIMITS OF VOYAGE**

Date..... 20.....	..... <i>Signature of Applicant</i>
	..... <i>Name (Please Print)</i>
<b>APPROVED ON BEHALF OF THE MINISTER</b>	Date..... 20.....
..... <i>Signature</i>	..... <i>Title</i>
Notes:	
(1) This application must be accompanied by the following completed registration documents unless the documents have already been submitted to the Registrar at the intended Port of Registry: Builder's Certificate, Application for Registration, Declaration of Ownership, Notice of Proposed Name.	
(2) Where an application for registration has been made to the Administration of a foreign State, conformation of that Administration's agreement to the issue of a Temporary Pass must be submitted in addition to the above documents.	
*Delete as applicable.	

Maritime Services Division  
Ship Registration

No. R 22

UNOFFICIAL VERSION

UPDATED TO 31ST DECEMBER 2016

**FORM NO. R 23**

REPUBLIC OF  
TRINIDAD AND TOBAGO

**TEMPORARY PASS  
(for an unregistered ship)**

OFFICIAL NUMBER	NAME OF SHIP	INTENDED PORT OF REGISTRY
-----------------	--------------	---------------------------

**PARTICULARS OF SHIP**

<b>Propulsion</b>				
<input type="checkbox"/> None <input type="checkbox"/> Sail <input type="checkbox"/> Auxiliary <input type="checkbox"/> Motor <input type="checkbox"/> Steam <input type="checkbox"/> Other (Specify)				
No. of Screws/Paddles, etc.			If sail, how rigged	
<b>Main Dimensions</b>				
LENGTH (Specify)...	Feet	Inches	Metres	Centimetres
.....				
MAXIMUM BREADTH TO OUTSIDE OF HULL				
DEPTH IN HOLD FROM TONNAGE DECK TO CEILING/TANK TOP AMIDSHIPS...				
DEPTH FROM TOP OF UPPER DECK AT SIDE AMIDSHIPS TO BOTTOM OF KEEL				
LENGTH OF ENGINE ROOM (IF ANY)				

**TONNAGE**

Gross Tonnage	Tons	Cu. Metres	*Net/Register Tonnage	Tons	Cu. Metres
...			...		

TYPE OF SHIP	CONSTRUCTION MATERIAL

**DETAILS OF OWNERS**

Full Name	Address	Occupation	No. of Shares

I, the undersigned, Registrar of Ships at the port of .....  
 upon application of .....hereby certify that pursuant to section 33 of the Shipping Act, Chap. 50:10  
 and regulation 15 of the Shipping (Regulations of Ships) Regulations, the Minister has directed that permission be granted for  
 the above-named ship to pass as follows:

**PARTICULARS OF VOYAGE**

From the Port of .....	To the Port of .....
Limitation .....	
.....	
.....	
Date of Commencement .....	Date of Completion.....
..... 20 .....	.....
<i>Signature of Registrar</i>	
*Delete as applicable.	

LAWS OF TRINIDAD AND TOBAGO

MINISTRY OF THE ATTORNEY GENERAL AND LEGAL AFFAIRS

www.legalaffairs.gov.tt

294

Chap. 50:10

Shipping

[Subsidiary]

Shipping (Registration of Ships) Regulations

FORM NO. R 24

REPUBLIC OF TRINIDAD AND TOBAGO

DECLARATION FOR TRANSFER OF PORT OF REGISTRY

TO THE REGISTRAR
PORT OF 20.....

I/We (a)..... being (b) ..... Owner(s) of the (c)..... ship "....." Official Number ..... and registered at the Port of ..... number ..... in the year .....do hereby declare that I/We require you to transfer the registry of the said ship to the port of ..... Made and subscribed the ..... day of ..... 20 ..... IN THE PRESENCE OF Signature Name (Please Print) Address Signature Title SEAL (a) Full names. (b) Sole, several or joint. (c) Sailing, steam or motor. NOTES: If there are any mortgages, this Declaration must be accompanied by the written consent of each Mortgagee. If the Owner or Mortgagee is a Corporation, the Declaration or consent should be made by the Secretary or by some other Public Officer of the Corporation who is duly authorised under the Seal of the Corporation for that purpose. ALL OWNERS AND MORTGAGEES MUST CONCUR IN THIS DECLARATION.

FORM NO. R 25

REPUBLIC OF  
TRINIDAD AND TOBAGO

NOTICE OF APPOINTMENT/CHANGE OF MASTER

I/We ..... *Full Name of Owner(s)* .....

.....

of ..... *Address* .....

.....

being registered owner(s) of ..... *No. of Shares* ..... shares of the ..... *Steam, Motor or Sailing* .....

Ship ..... *Name of ship* .....

Official Number ..... Port of Registry .....

Gross Tonnage ..... Net/Register Tonnage\* .....

hereby declare that I/We have appointed ..... *Full Name* .....

..... *Address* ..... Certificate No. ....

as Master of the Ship.

Name of Former Master (if any) ..... Certificate No. ....

Declared before me

this ..... day of ..... 20 .....

..... *Signature of Witness* .....

..... *Name, Address and Occupation of Witness* .....

.....

..... *Signature* .....

..... *Title (Please Print)* .....

SEAL

\*Delete as applicable

**LAWS OF TRINIDAD AND TOBAGO**

MINISTRY OF THE ATTORNEY GENERAL AND LEGAL AFFAIRS

www.legalaffairs.gov.tt

296

**Chap. 50:10**

*Shipping*

**[Subsidiary]**

*Shipping (Registration of Ships) Regulations*

**FORM NO. R 26**

REPUBLIC OF  
TRINIDAD AND TOBAGO

**REPORT OF APPOINTMENT/CHANGE OF MASTER**

OFFICIAL NO.  (1)	NAME OF SHIP  (2)	NO. AND DATE OF REGISTRY  (3)	PORT OF REGISTRY  (4)
NAME OF MASTER OR NEW MASTER  (5)		NO. OF HIS CERTIFICATE  (6)	ADDRESS OF MASTER OR NEW MASTER  (7)
NAME OF FORMER MASTER  (8)		NO. OF HIS CERTIFICATE  (9)	
<p>This is to certify that the name of the Master named in column 5, and the number of his Certificate have this day been endorsed on the Certificate of Registry of the above-named ship.</p> <p>Dated at ..... this..... day of ..... 20.....</p> <p align="center">..... <i>Signature</i></p> <p align="center">..... <i>Title</i></p>			

Maritime Services Division  
Ship Registration

No. R 26

UNOFFICIAL VERSION

UPDATED TO 31ST DECEMBER 2016

FORM NO. R 27

REPUBLIC OF  
 TRINIDAD AND TOBAGO

TRANSCRIPT

OFFICIAL NUMBER	NAME OF SHIP	INTENDED PORT OF REGISTRY

PARTICULARS OF SHIP

<b>Propulsion</b>					
<input type="checkbox"/> None	<input type="checkbox"/> Sail	<input type="checkbox"/> Auxiliary	<input type="checkbox"/> Motor	<input type="checkbox"/> Steam	<input type="checkbox"/> Other (Specify)
No. of Screws/Paddles, etc.			If sail, how rigged		
<b>Main Dimensions</b>					
LENGTH (Specify)...					
MAXIMUM BREADTH TO OUTSIDE OF HULL					
DEPTH IN HOLD FROM TONNAGE DECK TO CEILING/TANK TOP AMIDSHIPS...					
DEPTH FROM TOP OF UPPER DECK AT SIDE AMIDSHIPS TO BOTTOM OF KEEL					
LENGTH OF ENGINE ROOM (IF ANY)					

NO. OF DECKS	NO. OF MASTS	NO. OF BULKHEADS	STEM	STERN
WHERE BUILT		DATE BUILT	NAME AND ADDRESS OF BUILDER	
TYPE OF SHIP	CONSTRUCTION MATERIAL			

PARTICULARS OF TONNAGE

The tonnages of this ship, in accordance with its International or Trinidad and Tobago Tonnage Certificate are:		
GROSS TONNAGE .....	tons ( .....cubic metres)	
NET/REGISTER TONNAGE .....	tons ( .....cubic metres)	
Delete if not applicable	This ship is assigned with a tonnage mark on each side of the ship which is ..... inches below the upper deck line and when this mark is submerged the above tonnages are applicable. When the tonnage mark is NOT submerged the following tonnages are applicable:	
	GROSS TONNAGE .....	tons ( .....cubic metres)
	NET/REGISTER TONNAGE .....	tons ( .....cubic metres)
	A detailed summary of the tonnages for the ship is shown on its International or Trinidad and Tobago Tonnage Certificate.	

PARTICULARS OF PROPELLING ENGINES, ETC.

No. of Engines	Type of Engines	Power		Boilers	
		KW		No.	
No. of Shafts	Name and Address of Maker	N.H.P.		Type	
		B.H.P.		Load Pressure	
Date made		I.H.P.		Date made	
		Estd. Spd.			

No. R 27  
 P.T.O.

**LAWS OF TRINIDAD AND TOBAGO**

MINISTRY OF THE ATTORNEY GENERAL AND LEGAL AFFAIRS

www.legalaffairs.gov.tt

298

**Chap. 50:10**

*Shipping*

[Subsidiary]

*Shipping (Registration of Ships) Regulations*

**FORM NO. R 27—Continued**

The number of seamen and apprentices for whom accommodation is certified .....

DETAILS OF OWNERS

Full Name of Owners	Address	Occupation	No. of Shares

I, the undersigned Registrar of ships, hereby certify that the above particulars are correct.

Dated at ..... on the ..... day of ..... 20.....

.....  
*Signature*

.....  
*Port of Registry*

.....  
*Name (Please Print)*

Note: See other side for details of any encumbrances.

Details of Outstanding Encumbrances:

.....  
*Date*

.....  
*Registrar*

.....  
*Port of Registry*

Maritime Services Division  
Ship Registration

UNOFFICIAL VERSION

UPDATED TO 31ST DECEMBER 2016

**FORM NO. R 27—T**

REPUBLIC OF  
TRINIDAD AND TOBAGO

**TRANSCRIPT  
(Tug)**

OFFICIAL NUMBER	NAME OF SHIP	No.	YEAR	PORT OF REGISTRY

PARTICULARS OF SHIP

<b>Propulsion</b>				
<input type="checkbox"/> None <input type="checkbox"/> Sail <input type="checkbox"/> Auxiliary <input type="checkbox"/> Motor <input type="checkbox"/> Steam <input type="checkbox"/> Other (Specify)				
No. of Screws/Paddles, etc.			If sail, how rigged	
<b>Main Dimensions</b>			Feet	Inches
LENGTH (Specify).....				
MAXIMUM BREADTH TO OUTSIDE OF HULL .....				
DEPTH IN HOLD FROM TONNAGE DECK TO CEILING/TANK TOP AMIDSHIPS....				
DEPTH FROM TOP OF UPPER DECK AT SIDE AMIDSHIPS TO BOTTOM OF KEEL				
LENGTH OF ENGINE ROOM (IF ANY) .....				

NO. OF DECKS	NO. OF MASTS	NO. OF BULKHEADS	STEM	STERN
WHERE BUILT		DATE BUILT	NAME AND ADDRESS OF BUILDER	
TYPE OF SHIP	CONSTRUCTION MATERIAL			

PARTICULARS OF TONNAGE

The tonnages of this ship, in accordance with its International or Trinidad and Tobago Tonnage Certificate are:	
GROSS TONNAGE .....	tons ( .....cubic metres)
NET/REGISTER TONNAGE .....	tons ( .....cubic metres)
If and when employed for the carriage of passengers, cargo or stores, or using graving docks or dry docks or places provided for the repairing of vessels, the register tonnage on which dues based on register tonnage may be levied by any harbour or dock authority is ..... tons.	
A detailed summary of the tonnages for the ship is shown on its International or Trinidad and Tobago Tonnage Certificate.	

PARTICULARS OF PROPELLING ENGINES, ETC.

No. of Engines	Type of Engines	Power		Boilers	
		KW		No.	
No. of Shafts	Name and Address of Maker	N.H.P.		Type	
		B.H.P.		Load Pressure	
Date made		I.H.P.		Date made	
		Estd. Spd.			

No. R 27  
P.T.O.

**FORM NO. R 27—T—Continued**

The number of seamen and apprentices for whom accommodation is certified .....

DETAILS OF OWNERS

Full Name of Owners	Address	Occupation	No. of Shares

I, the undersigned Registrar of ships, hereby certify that the above particulars are correct.

Dated at ..... on the ..... day of ..... 20.....

.....  
*Signature* *Port of Registry*

.....  
*Name (Please Print)*

Note: See other side for details of any encumbrances.

Details of Outstanding Encumbrances:

.....  
*Date* *Registrar*

.....  
*Port of Registry*

Maritime Services Division  
Ship Registration

**SECOND SCHEDULE**

**FEES**

<i>Service</i>	<i>Fee in TT\$</i>
First Registration	
Registration anew	
Re-registration... ..	<i>See tonnage rates below</i>
<i>(Gross tons)</i>	<i>(Rate per ton)</i>
0–100 ... ..	3.00
101–500 ... ..	2.50
501–1600 ... ..	2.00
1601–5000 ... ..	1.50
5001 and over ... ..	1.00
minimum fee of \$150.00	
10% of the fees paid on first registration is payable annually in respect of each registered ship.	
Issue of a Provisional Certificate of Registry ... ..	100.00
Issue of a Temporary Pass ... ..	150.00
Change of Name of a Ship including consequential amendment to the ship's statutory safety certificates ... ..	400.00
Registration of alterations (other than Registration anew) including consequential amendments to the Ship's Statutory Safety Certificate ... ..	350.00
Issue of replacement or duplicate Certificate of Registry	75.00
Change of Port of Registry of a ship including consequential amendments to the ship's Statutory Safety Certificates ...	350.00
The registration of—	
(a) the transfer of ownership or a share thereof by bill of sale or transmission	
(b) a mortgage	
(c) the transfer of a mortgage ... ..	250.00
The recording of a discharge of a mortgage ... ..	10.00

**LAWS OF TRINIDAD AND TOBAGO**

MINISTRY OF THE ATTORNEY GENERAL AND LEGAL AFFAIRS

www.legalaffairs.gov.tt

302

**Chap. 50:10**

*Shipping*

[Subsidiary]

*Shipping (Registration of Ships) Regulations*

**SECOND SCHEDULE—Continued**

Registration of Ships under Construction

<i>(Gross tons)</i>	<i>(Rate per ton)</i>
0-100 ... ..	1.50
101-500 ... ..	1.25
501-1600 ... ..	1.00
1601-5000 ... ..	0.75
5001 and over... .. minimum fee of \$75.00	0.50
Registration of change of name of Company ... ..	50.00
Endorsement of change of Master ... ..	30.00
<i>Service</i>	<i>Fee in TT\$</i>
Each inspection of a Register Book ... ..	20.00
Supplying a certified copy of entries in a Register ... ..	60.00
Supplying a copy of a document relating to the registration of a ship ... ..	25.00

*Note 1*

Whilst the above fees are quoted in TT\$, the Registrar or Proper Officer may accept payment in US dollars, EC dollars or any other currency acceptable to the Registrar and at the prevailing rate of exchange.

*Note 2*

Where any service is provided which is not specified above, the fee payable will be determined according to the amount of work involved.

*Note 3*

All fees are payable in advance.

UNOFFICIAL VERSION

UPDATED TO 31ST DECEMBER 2016

**SHIPPING (TONNAGE) REGULATIONS**

ARRANGEMENT OF REGULATIONS

REGULATION

1. Citation.

**PART I**

**GENERAL**

2. Definitions.

**PART II**

**APPLICATION, ASCERTAINMENT OF TONNAGE AND  
CERTIFICATION FOR NEW SHIPS AND CERTAIN  
EXISTING SHIPS OF TWENTY-FOUR METRES IN  
LENGTH AND OVER**

3. Application of Part II.
4. Method of measurement.
5. Calculation of volumes.
6. Gross tonnage.
7. Net tonnage.
8. Miscellaneous tonnages.
9. Issue of certificates.
10. Cancellation of certificates.
11. Change of net tonnage necessitating issue of certificate.

**PART III**

**APPLICATION, ASCERTAINMENT OF TONNAGE AND  
CERTIFICATION FOR ALL SHIPS OF LESS THAN  
TWENTY-FOUR METRES IN LENGTH  
INCLUDING PLEASURE CRAFT**

12. Application of Part III.

**LAWS OF TRINIDAD AND TOBAGO**

MINISTRY OF THE ATTORNEY GENERAL AND LEGAL AFFAIRS

www.legalaffairs.gov.tt

304

**Chap. 50:10**

*Shipping*

[Subsidiary]

*Shipping (Tonnage) Regulations*

ARRANGEMENT OF REGULATIONS—*Continued*

**REGULATION**

**PART IV**

**APPLICATION, ASCERTAINMENT OF TONNAGE  
AND CERTIFICATION OF EXISTING SHIPS OF  
TWENTY-FOUR METRES IN LENGTH AND OVER  
UNTIL 17TH JULY, 1994.**

13. Application of Part IV.

**PART V**

**FOREIGN SHIPS WHILST WITHIN TRINIDAD AND  
TOBAGO OR THE TERRITORIAL WATERS THEREOF**

14. Acceptance of foreign Tonnage Certificates.  
15. Ascertainment of Tonnage and Certification.

**PART VI**

**INTERIM SCHEME FOR TONNAGE MEASUREMENT  
FOR CERTAIN SHIPS**

16. Application of Part VI.

**PART VII**

**PENALTIES**

17. Penalties.

**FIRST SCHEDULE.**

**SECOND SCHEDULE.**

**THIRD SCHEDULE.**

**FOURTH SCHEDULE.**

**APPENDIX A.**

**APPENDIX B.**

**APPENDIX C.**

**APPENDIX D.**

**APPENDIX E.**

---

UNOFFICIAL VERSION

UPDATED TO 31ST DECEMBER 2016

**SHIPPING (TONNAGE) REGULATIONS**

147/1988.

*made under section 22(2)*

1. These Regulations may be cited as the Shipping (Tonnage) Regulations. Citation.

**PART I**

**GENERAL**

2. In these Regulations, unless the context otherwise requires— Definitions.

“Act” means the Shipping Act;

“Administration” means the Government of the State whose flag the ship is flying;

“amidships” means the mid-point of the length as defined below;

“breadth” means the maximum breadth of the ship, measured amidships to the moulded line of the frame in a ship with a metal shell and to the outer surface of the hull in a ship with a shell of any other material;

“cargo spaces” means enclosed spaces which are included in the computation of gross tonnage and are appropriated for the transport of cargo to be discharged from the ship and which are permanently marked with the letters “CC” which mean cargo compartment, such letters being not less than one hundred millimetres in height and so positioned as to be readily visible;

“certifying authority” means the Minister or any person authorised by the Minister for the purposes of these Regulations and includes in particular, if so authorised, Lloyd’s Register of Shipping, Bureau Veritas, Det Norske Veritas, Germanischer Lloyd and the American Bureau of Shipping;

“contracting government” means the Government of a country which has accepted the International Convention on Tonnage Measurement of Ships, 1969;

“convention” means the International Convention on Tonnage Measurements of Ships, 1969;

“enclosed spaces” means all those spaces, other than excluded spaces, which are bounded by the ship’s hull, by fixed or portable partitions or bulkheads, or by decks or coverings other than permanent or moveable awnings and without limiting the generality of the foregoing, no break in a deck, nor any opening in the ship’s hull, a deck, a covering of a space, or the partitions or bulkheads of a space, nor the absence of a partition or bulkhead, precludes a space from being included in the enclosed spaces; furthermore, notwithstanding the definition of “excluded spaces” provided below, any space which fulfils at least one of the following conditions is treated as an enclosed space:

- (a) a space fitted with shelves or other means for securing cargo or stores;
- (b) a space fitted with any means of closing the openings therein;
- (c) a space constructed in such a way so that there exists any possibility of an opening mentioned in paragraph (b) of the interpretation for “excluded spaces” given below being closed;

“excluded spaces” referred to in the definition of enclosed spaces, means—

- (a) that part of an enclosed space within an erection opposite an end opening and extending from the opening to an athwartship line at a fore and aft distance from the opening equal to half the breadth of the deck of the line of the opening, such end having a breadth equal to or greater than ninety per cent of the breadth of the deck at the line of the opening and extending from deck to deck or to a curtain plate of a depth not exceeding by more than twenty-five millimetres the depth of the adjacent deck beams, as specified in figure 1 of the First Schedule hereto; save that—
  - (i) where any point the width of the enclosed space because of any arrangement except

covergence of the outside plating, as specified in figure 3 of the First Schedule hereto, becomes less than ninety per cent of the breadth of the deck at the line of the opening, the excluded space extends only to an athwartship line intersecting that point, as specified in figures 2 and 4 of the First Schedule hereto;

- (ii) where the opposite ends of two enclosed spaces are separated by a gap, which is completely open except for bulwarks or open rails and of fore and aft length less than half the least breadth of the deck at the gap, then no part of the enclosed spaces are excluded, as specified in figures 5 and 6 of the First Schedule hereto;
- (b) a space under an overhead deck covering open to the sea and weather having no other connection on the exposed sides with the body of the ship than the stanchions necessary for its support, however, in such a space, open rails or a bulwark and curtain plate may be fitted or stanchions fitted at the ship's side, save that the distance between the top of the rails or the bulwark and the curtain plate is not less than three-quarters of a metre or one-third of the height of the space, whichever is the greater, as specified in figure 7 of the First Schedule hereto;
- (c) a space in a side-to-side erection between opposite side openings not less in height than three-quarters of a metre or one-third of the height of the erection, whichever is the greater, save that where the opening in such an erection is provided on one side only, the space to be excluded from the volume of enclosed spaces is limited inboard from the opening to a maximum of one-half of the

First Schedule.

LAWS OF TRINIDAD AND TOBAGO

MINISTRY OF THE ATTORNEY GENERAL AND LEGAL AFFAIRS

www.legalaffairs.gov.tt

308

Chap. 50:10

Shipping

[Subsidiary]

Shipping (Tonnage) Regulations

First Schedule.

breadth of the deck in way of the opening, as specified in figure 8 of the First Schedule hereto;

(d) a space in an erection immediately below an uncovered opening in the deck overhead, save that such an opening is exposed to the weather and the space excluded from enclosed spaces is limited to the area of the opening, as specified in figure 9 of the First Schedule hereto;

(e) a recess in the boundary bulkhead of an erection which is exposed to the weather and the opening of which extends from deck to deck without means of closing, save that the interior width is not greater than the width at the entrance and its extension into the erection is not greater than twice the width of its entrance, as specified in figure 10 of the First Schedule hereto;

“existing ship” means a ship which is not a new ship;

“length” means the greater of the following distances:

(a) the distance between the foreside of the stem and the axis of the rudder stock; or

(b) a distance measured from the foreside of the stem, being ninety-six per cent of the distance between that point and the aft side of the stern,

the said points and measurements being taken respectively at and along a waterline at eighty-five per cent of the least moulded depth of the ship, the waterline, being taken to be parallel to the designed waterline in the case of a ship having a rake of keel;

Sub. Leg.

“load line regulations” means any Shipping (Load Line) Regulations to be made under the Act and includes in relation to any ship not registered in Trinidad and Tobago any corresponding regulations of the State in which the ship is registered;

“moulded depth” means—

(a) the vertical distance measured from the top of the keel to the underside of the upper deck at side,

UNOFFICIAL VERSION

UPDATED TO 31ST DECEMBER 2016

such distance being measured from the lower edge of the keel rabbet, in the case of wood and composite ships, and where the form at the lower part of the midship section is of a hollow character, or where thick garboards are fitted, the distance being measured from the point where the line of the flat of the bottom continued inwards cuts the side of the keel;

- (b) in ships having rounded gunwales, the depth measured to the point of intersection of the moulded lines of the deck and side shell plating, the lines extending as though the gunwales were of angular design;
- (c) where the upper deck is stepped and the raised part of the deck extends over the point at which the moulded depth is to be determined, the depth measured to a line of reference extending from the lower part of the deck along a line parallel to the raised part;

For the purposes of the definition of “moulded depth”—

- (i) “upper deck” means the uppermost complete deck exposed to weather and sea, which has a permanent means of weathertight closing all openings in the weather part thereof, and below which all openings in the sides of the ship are fitted with permanent means of watertight closing and in a ship having a stepped upper deck, the lowest line of the exposed deck and the continuation of that line parallel to the upper part of the deck, and
- (ii) “weathertight” means that in any sea conditions water will not penetrate into the ship;

“moulded draught” means—

- (a) for ships assigned load lines in accordance with the Load Line Regulations, the draught corresponding to the Summer Load Line, other than timber load lines;
- (b) for passenger ships, the draught corresponding to the deepest subdivision load line assigned in accordance with any Shipping (Passenger Ship Construction) Regulations made under the Act;
- (c) for ships to which no load line has been assigned but the draught of which is restricted by the Minister, the maximum permitted draught;
- (d) for other ships, seventy-five per cent of the moulded depth amidships as defined in this Regulation;

“new ship” means a ship the keel of which is laid, or which is at a similar stage of construction, on or after the 18th July, 1982, and for the purposes of this definition “a similar stage of construction” means the stage at which—

- (a) construction identifiable with a specific ship begins; and
- (b) assembly of that ship has commenced comprising at least fifty tonnes or one per cent of the estimated mass of all structural material whichever is the less;

“oil tanker” means a ship constructed or adapted to carry oil in bulk in its cargo spaces and includes combination carriers and for the purposes of this definition “combination carrier” means a ship designed to carry either oil or solid cargoes in bulk;

“passenger” means any person carried in a ship except—

- (a) a person employed or engaged in any capacity on board the ship on the business of the ship;
- (b) a person on board the ship either in pursuance of the obligation laid upon the master to carry

shipwrecked, distressed or other persons, or by reason of any circumstances that neither the master, the owner nor the charterer, if any, could have prevented; and

(c) a child under one year of age;

“pleasure craft” means a vessel primarily used for sport or recreation;

“surveyor” means a surveyor appointed by a Certifying Authority.

**PART II**

**APPLICATION, ASCERTAINMENT OF TONNAGE AND  
CERTIFICATION FOR NEW SHIPS AND CERTAIN  
EXISTING SHIPS OF TWENTY-FOUR METRES  
IN LENGTH AND OVER**

**3.** (1) This Part and the First, Second and Third Schedules hereto shall apply to the following ships and fishing vessels registered or to be registered in Trinidad and Tobago under Part III of the Act, being ships of twenty-four metres in length or over—

Application of  
Part II.  
First Schedule.  
Second  
Schedule.  
Third Schedule.

(a) new ships;

(b) existing ships to which regulation 13(1) would otherwise apply but which undergo alterations or modifications resulting in a substantial variation in their existing gross tonnages;

(c) existing ships, if an owner so requests;

(d) all ships with effect from 18th July, 1994.

(2) Existing ships the tonnages of which have once been determined under this Part pursuant to a request of the owner under subregulation (1)(c) above shall not subsequently have their tonnages determined in accordance with Part IV.

**4.** (1) The owner and the master of a ship to be measured shall make it available for measurement by a surveyor and afford all necessary facilities for its survey and measurement and shall produce such plans, drawings, specifications and

Method of  
measurement.

LAWS OF TRINIDAD AND TOBAGO

MINISTRY OF THE ATTORNEY GENERAL AND LEGAL AFFAIRS

www.legalaffairs.gov.tt

312

Chap. 50:10

Shipping

[Subsidiary]

Shipping (Tonnage) Regulations

other documents relating to the ship that the surveyor may require for his use or retention.

(2) The gross and net tonnages shall be determined in accordance with regulations 6 and 7 save that in the case of novel types of craft with constructional features which render the application of the provisions of these Regulations unreasonable or impracticable, the gross and net tonnages shall be determined as required by the Minister.

(3) All measurements used in the calculation of volumes shall be taken and expressed in metres to the nearest centimetre.

(4) Gross and net tonnages shall be expressed as whole numbers, decimals being rounded off downwards.

Calculation of volumes.

**5.** (1) All volumes included in the calculation of gross and net tonnages shall be measured, irrespective of the fitting of insulation or the like, to the inner side of the shell or structural boundary plating in ships constructed of metal, and to the outer surface of the shell or to the inner side of the structural boundary surfaces in ships constructed of any other material.

(2) Volumes of appendages shall be included in the total volume.

(3) Volumes of spaces open to the sea shall be excluded from the total volume.

(4) The method and accuracy of the calculations shall be to the satisfaction of the Minister and shall be sufficiently detailed to facilitate checking.

Gross tonnage.

**6.** The gross tonnage (GT) of a ship shall be determined by the formula  $GT=K_1 V$  where—

V= total volume of all enclosed spaces of the ship in cubic metres;

$K_1=0.2 + 0.02 \log_{10} V$ , or as specified in the Second Schedule.

UNOFFICIAL VERSION

UPDATED TO 31ST DECEMBER 2016

7. The net tonnage (NT) of a ship shall be determined by the formula <sup>Net tonnage.</sup>

$$\text{NT} = K_2 V_c \left( \frac{4d}{3D} \right)^2 = K_3 \left( \frac{N_2}{N_1 + 10} \right)$$

where—

$V_c$  =total volume of cargo spaces in cubic metres;

$K_2 = 0.2 + 0.02 \log V_c$  (or as specified in the Second Schedule);

$$K_3 = 1.25 \frac{GT + 10,000}{10,000}$$

where  $GT$  =gross tonnage calculated in accordance with regulation 6.

$D$  =moulded depth amidships in metres.

$d$  =moulded draught amidships in metres.

$N_1$  =number of passengers in cabins with not more than 8 berths.

$N_2$  =number of other passengers.

However:

(a) the factor  $\left( \frac{4d}{3D} \right)^2$

shall not be taken as greater than unity;

(b) the term

$$K_2 V_c \left( \frac{4d}{3D} \right)^2$$

shall not be taken as less than 0.25  $GT$ ;

LAWS OF TRINIDAD AND TOBAGO

MINISTRY OF THE ATTORNEY GENERAL AND LEGAL AFFAIRS

www.legalaffairs.gov.tt

314

Chap. 50:10

Shipping

[Subsidiary]

Shipping (Tonnage) Regulations

- (c)  $N_1$  and  $N_2$  shall be taken as zero when  $N_1 + N_2$  is less than 13;
- (d) NT shall not be taken as less than 0.30 GT.

Miscellaneous tonnages.

8. (1) Where segregated ballast tanks complying with regulation 13 of Annex 1 of the International Convention for the Prevention of Pollution from Ships, 1973 as modified by the Protocol of 1978 relating to that Convention are provided in oil tankers, an entry may be made on the International Tonnage Certificate (1969) indicating the total tonnage of these tanks. The tonnage of such segregated ballast tanks shall be calculated according to the formula  $K_1 \times V_b$  where—

$K_1 = 0.2 + 0.02 \log_{10} V$  or as specified in the Second Schedule; and

$V_b$  = the total volume of all enclosed spaces of the ship in cubic metres measured in accordance with regulation 5.

(2) Where cargo is carried in any uncovered space on deck, the tonnage of the space so occupied shall be determined by the formula—

Deck Cargo Tonnage = 0.353 (mean length x mean breadth x mean height) and dues payable with respect to cargo carried on deck or in spaces not forming part of the ship's gross or net tonnages shall be based on the tonnage so determined.

Issue of certificates.

9. The Certifying Authority shall, upon receipt of the appropriate fee, issue to the owner of every ship registered in Trinidad and Tobago under the Act, the tonnages of which have been ascertained in accordance with regulations 6 and 7, an International Tonnage Certificate (1969) in the form set out in

UNOFFICIAL VERSION

UPDATED TO 31ST DECEMBER 2016

the Third Schedule, certifying the tonnages of the ship and containing the following particulars:

- (a) the name, port of registry and official number of the ship;
- (b) its length, breadth and moulded depth;
- (c) its gross and net tonnages;
- (d) the date on which the keel was laid or the ship was at a similar stage of construction or date on which the ship underwent alterations or modifications of a major character.

**10.** (1) Where alterations are made in the arrangement, construction, capacity, use of spaces, total number of passengers the ship is permitted to carry under the terms of the ship's passenger certificate, assigned load line, or permitted draught of the ship such as would cause an increase in the gross or net tonnage, the existing International Tonnage Certificate (1969) shall cease to be valid and shall be delivered up to and cancelled by the Certifying Authority.

Cancellation of certificates.

(2) When a ship is transferred from the Trinidad and Tobago Register the International Tonnage Certificate (1969) shall cease to be valid except when the transfer is to the Administration of a State which is a Contracting Government in which case the certificate may remain in force for a period not exceeding three months or until the new Administration issues another International Tonnage Certificate (1969) whichever is the earlier.

(3) The Certifying Authority shall transmit to the Administration of a contracting Government referred to in subsection (2) as soon as possible after the transfer has taken place a copy of the certificate carried by the ship at the time of transfer and a copy of the relevant tonnage calculations.

**11.** (1) When alterations in the values of  $V$ ,  $V_c$ ,  $d$ ,  $N_1$  or  $N_2$  as defined in regulations 6 and 7 result in an increase in the net tonnage a new International Tonnage Certificate (1969) incorporating the increase net tonnage shall be issued.

Change of net tonnage necessitating issue of certificate.

(2) In the case of a passenger ship assigned subdivision load lines in accordance with any Shipping (Passenger Ship Construction) Regulations and load lines in accordance with any Shipping (Load Lines) Regulations, only one net tonnage shall be applied and where the draught corresponding to the Summer load line differs from that corresponding to the deepest subdivision load line the net tonnage shall be the greater of the two values determined in accordance with regulation 7 by applying the differing draughts.

(3) Subject to subregulation (4) where alterations in the values of  $V$ ,  $V_c$ ,  $d$ ,  $N_1$  or  $N_2$  as defined in regulations 6 and 7, or changes in the position of the load lines result in a decrease in the net tonnage, a new International Tonnage Certificate (1969) incorporating the decreased net tonnage shall not be issued until twelve months have elapsed from the date on which the current certificate was issued.

(4) A new International Tonnage Certificate (1969) may be issued when—

- (i) a ship which was registered outside Trinidad and Tobago is registered in Trinidad and Tobago; or
- (ii) a ship undergoes alterations or modifications of a major character, such as the removal of a superstructure, which requires an alteration of the assigned load line.

### PART III

#### APPLICATION, ASCERTAINMENT OF TONNAGE AND CERTIFICATION FOR ALL SHIPS OF LESS THAN TWENTY-FOUR METRES IN LENGTH INCLUDING PLEASURE CRAFT

Application of Part III.

**12.** (1) This Part shall apply to all ships of less than twenty-four metres in length, including pleasure craft and fishing vessels to be registered under Part III of the Act.

(2) Ships, fishing vessels and pleasure craft to which this Part applies shall have their tonnages ascertained in accordance with the Fourth Schedule and Appendices A to E thereto.

Fourth  
Schedule.

**PART IV**

**APPLICATION, ASCERTAINMENT OF TONNAGE AND  
CERTIFICATION OF EXISTING SHIPS OF  
TWENTY-FOUR METRES IN LENGTH AND OVER  
UNTIL 17TH JULY, 1994**

**13.** (1) This Part shall apply to existing ships of twenty-four metres in length and over registered or to be registered in Trinidad and Tobago.

Application of  
Part IV.

(2) This Part shall not apply to existing ships referred to in regulation 3(1)(b) and (c).

(3) Ships to which this Part applies shall, until 17th July, 1994, continue to have their tonnages ascertained in accordance with the Fourth Schedule and Appendices A to D thereto.

Fourth  
Schedule.

**PART V**

**FOREIGN SHIPS WHILST WITHIN TRINIDAD AND  
TOBAGO OR THE TERRITORIAL WATERS THEREOF**

**14.** (1) An International Tonnage Certificate (1969) issued under the authority of another Contracting Government to a foreign ship in accordance with the Convention shall be accepted and regarded for all purposes covered by the Convention as having the same validity as one issued under Part II of these Regulations and whilst such a ship is within Trinidad and Tobago or the waters thereof it may be subject to inspection by a person duly authorised by the Minister in that behalf for the purpose of verifying—

Acceptance of  
foreign Tonnage  
Certificates.

- (a) that the ship is provided with a valid International Tonnage Certificate (1969); and
- (b) that the main characteristics of the ship correspond to the data given in the certificate.

(2) Any such inspection shall not cause any delay to the ship.

(3) Where the inspection reveals that the main characteristics of the ship differ from those entered in the International Tonnage Certificate (1969) so as to lead to an increase in the gross tonnage or the net tonnage, the Administration of the State whose flag the ship is flying shall be informed without delay.

Ascertainment  
of Tonnage and  
Certification.

**15.** (1) The Certifying Authority may, at the request of the Administration of a Contracting Government ascertain the gross and net tonnages of a new foreign ship in accordance with Part II of these Regulations and issue to the owner an International Tonnage Certificate (1969) and in such cases the certificate shall be endorsed to the effect that it has been issued at the request of the Government of the State whose flag the ship is or will be flying, and a copy of the certificate and the calculations of the tonnages shall be transmitted to the requesting Government as soon as possible.

(2) The Certifying Authority may, at the request of an owner of a new foreign ship flying the flag of an Administration of a non-Contracting Government ascertain the gross and net tonnages of the ship in accordance with Part II of these Regulations and issue a Certificate of Trinidad and Tobago Tonnage Measurement and in such cases the certificate shall bear the endorsement “for use only whilst within Trinidad and Tobago or the waters thereof”.

(3) The Certifying Authority may, at the request of the Administration of a Contracting Government, ascertain the gross and net tonnages of an existing foreign ship in accordance with Part II of these Regulations and issue to the owner an International Tonnage Certificate (1969) and in such cases the certificate shall be endorsed to the effect that it has been issued at the request of the Government of the State whose flag the ship is or will be flying, and a copy of the certificate and the calculations of the tonnages shall be transmitted to the requesting Government as soon as possible.

(4) The Certifying Authority may, at the request of the owner of any existing foreign ship, ascertain the gross and net tonnages of the ship in accordance with Part IV of these Regulations until 17th July, 1994 and in such cases a Trinidad and Tobago Tonnage Certificate shall be issued.

**PART VI**

**INTERIM SCHEME FOR TONNAGE MEASUREMENT  
FOR CERTAIN SHIPS**

**16.** (1) The Minister may, at the request of an owner, permit the following Trinidad and Tobago ships which are required to be measured and surveyed in accordance with Part II, to have their gross tonnages ascertained by the Certifying Authority in accordance with the provisions as set out in the Fourth Schedule and Appendices A to C thereto and to use this tonnage for the purpose of the application of the provisions of Regulations implementing the Conventions as specified in subregulation (2)—

Application of  
Part VI.

Fourth  
Schedule.

- (a) a ship the keel of which is laid or is at a similar stage of construction not later than 31st December, 1985;
- (b) a ship which is a cargo ship of less than 1600 tons gross tonnage as ascertained in accordance with regulation 13(3), the keel of which is laid or is at a similar stage of construction not later than 17th July, 1994; or
- (c) a ship which is a ship of less than 400 tons gross tonnage as ascertained in accordance with regulation 13(3), the keel of which is laid or at a similar stage of construction not later than 17th July, 1994.

(2) Ships specified in subregulation (1)(a) and (b) may use the tonnages so ascertained for the application of the provisions of the Regulations implementing the International Convention for the Safety of Life at Sea 1974 and the Protocol relating thereto and

**LAWS OF TRINIDAD AND TOBAGO**

MINISTRY OF THE ATTORNEY GENERAL AND LEGAL AFFAIRS

www.legalaffairs.gov.tt

320

**Chap. 50:10**

*Shipping*

[Subsidiary]

*Shipping (Tonnage) Regulations*

of the International Convention on Standards of Training, Certification and Watchkeeping for Seafarers 1978.

(3) Ships specified in subregulation (1)(c) may use the tonnages so ascertained for the application of the provisions of the Regulations implementing the International Convention for the Prevention of Pollution from Ships, 1973, as modified by the Protocol of 1978 relating thereto, except that for ships, the keels of which are laid after 31st December, 1985, the tonnages so ascertained shall be used only in respect of such Regulations for ships of less than four hundred tons gross tonnage.

(4) The measurement of a ship in accordance with subregulation (1) shall be in respect of gross tonnage only and an appropriate Trinidad and Tobago Tonnage Certificate shall be issued which shall be endorsed as follows:

“For use only for the application of the Interim Scheme for Tonnage Measurement for Certain Ships (IMO Resolutions A494 (XII), A540(13) and A541(13)”.

(5) Where the gross tonnage is ascertained in accordance with subregulation (1) and a Safety of Life at Sea Convention Certificate or an International Oil Pollution Certificate of Marpol 73/78 or such other Official Certificate is subsequently issued, then only that tonnage shall be recorded in that certificate and it shall be endorsed as follows:

“The above gross tonnage has been measured by the Certifying Authority of Trinidad and Tobago in accordance with the Fourth Schedule of the Shipping (Tonnage) Regulations, 1988 of Trinidad and Tobago.”

Fourth  
Schedule.

**PART VII**

**PENALTIES**

Penalties.

**17.** (1) Any owner or master who fails without reasonable cause to deliver up a certificate for cancellation as required by regulation 10 or paragraph 4(3) of the Fourth Schedule shall be guilty of an offence and liable to a fine of five thousand dollars.

Fourth  
Schedule.

UNOFFICIAL VERSION

UPDATED TO 31ST DECEMBER 2016

(2) Where goods or stores are carried in a permanently closed-in space on board in contravention of paragraph 20 of the Fourth Schedule the master and the owner of the ship shall each be liable to a fine of five thousand dollars.

Fourth  
Schedule.

FIRST SCHEDULE

Enclosed and excluded spaces as defined in regulation 2

In the following figures: O = excluded space.

C = enclosed space.

I = space to be considered as an enclosed space.

Hatched in parts to be included as enclosed spaces.

B = breadth of the deck in way of the opening.

In ships with rounded gunwales the breadth is measured as indicated in Figure 11.

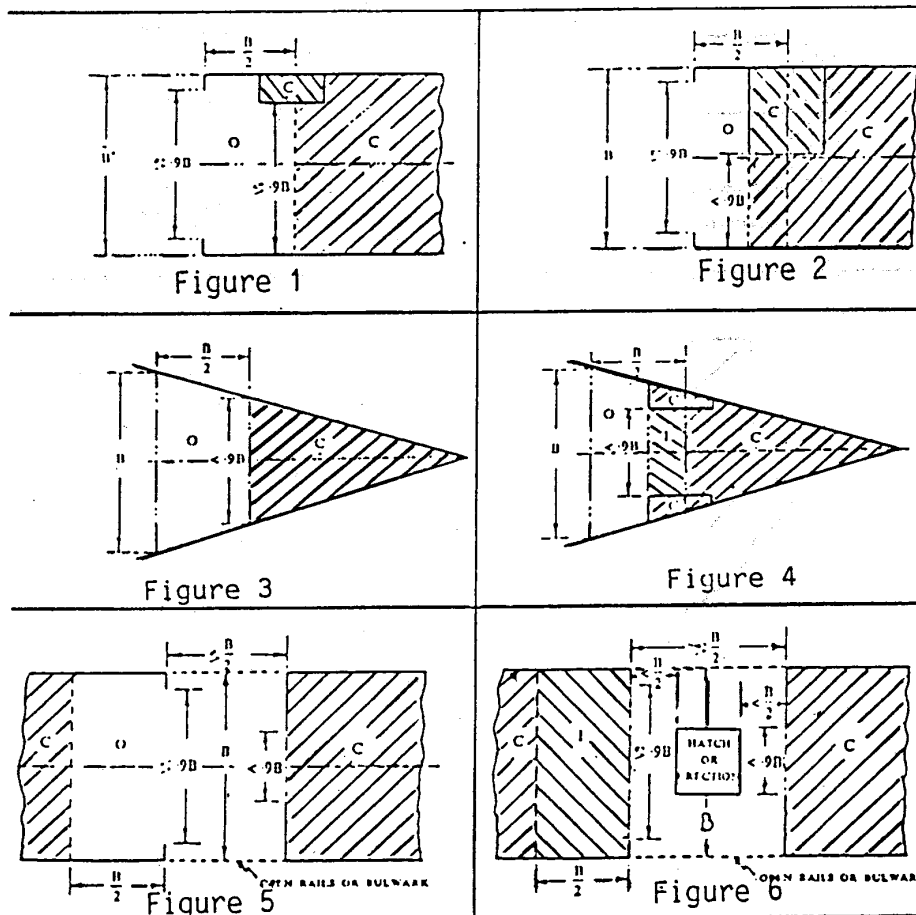

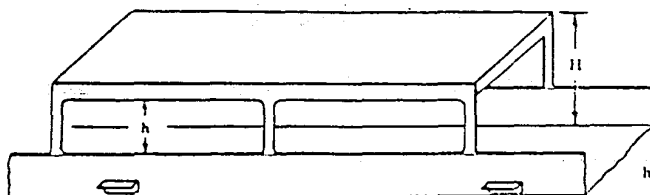
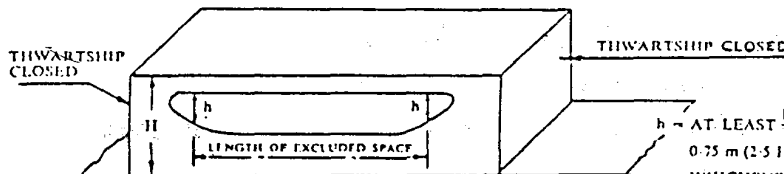
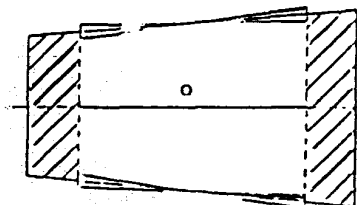

Figure 7

$h = \text{AT LEAST } \frac{H}{3} \text{ OR } 0.75 \text{ m (2.5 FEET)}$   
 WHICHEVER IS THE GREATER



$h = \text{AT LEAST } \frac{H}{3} \text{ OR } 0.75 \text{ m (2.5 FEET)}$   
 WHICHEVER IS THE GREATER



OPPOSITE SIDE OPENINGS

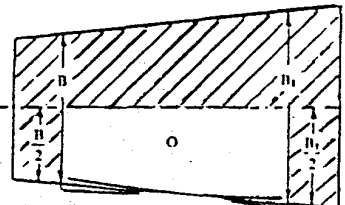

OPENING ON ONE SIDE ONLY

Figure 8

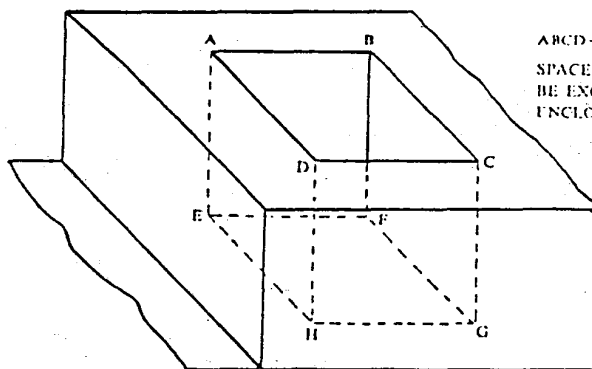

ABCD -- OPENING IN THE DECK  
 SPACE ABCDEFGH SHALL  
 BE EXCLUDED FROM  
 ENCLOSED SPACE

Figure 9

LAWS OF TRINIDAD AND TOBAGO

MINISTRY OF THE ATTORNEY GENERAL AND LEGAL AFFAIRS

www.legalaffairs.gov.tt

324

Chap. 50:10

Shipping

[Subsidiary]

Shipping (Tonnage) Regulations

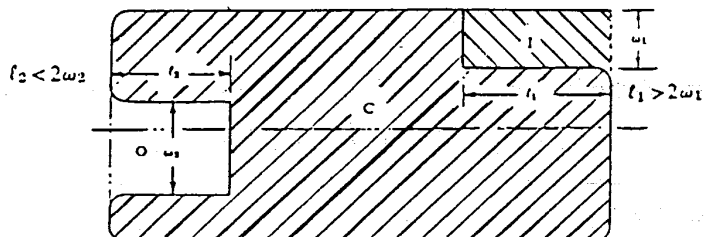

Figure 10

SHIPS WITH ROUNDED GUNWALES

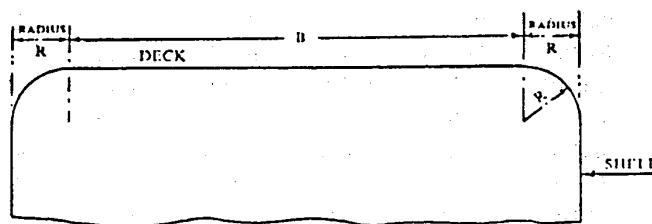

Figure 11

UNOFFICIAL VERSION

UPDATED TO 31ST DECEMBER 2016

**SECOND SCHEDULE**

Coefficients  $K_1$  and  $K_2$  referred to in regulations 6, 7 and 8

V or  $V_c$  = Volume in cubic metres

V or $V_c$	$K_1$ or $K_2$	V or $V_c$	$K_1$ or $K_2$	V or $V_c$	$K_1$ or $K_2$	V or $V_c$	$K_1$ or $K_2$
10	0.2200	45 000	0.2931	330 000	0.3104	670 000	0.3165
20	0.2260	50 000	0.2940	340 000	0.3106	680 000	0.3166
30	0.2295	55 000	0.2948	350 000	0.3109	690 000	0.3168
40	0.2320	60 000	0.2956	360 000	0.3111	700 000	0.3169
50	0.2340	65 000	0.2963	370 000	0.3114	710 000	0.3170
60	0.2356	70 000	0.2969	380 000	0.3116	720 000	0.3171
70	0.2369	75 000	0.2975	390 000	0.3118	730 000	0.3173
80	0.2381	80 000	0.2981	400 000	0.3120	740 000	0.3174
90	0.2391	85 000	0.2986	410 000	0.3123	750 000	0.3175
100	0.2400	90 000	0.2991	420 000	0.3125	760 000	0.3176
200	0.2460	95 000	0.2996	430 000	0.3127	770 000	0.3177
300	0.2495	100 000	0.3000	440 000	0.3129	780 000	0.3178
400	0.2520	110 000	0.3008	450 000	0.3131	790 000	0.3180
500	0.2540	120 000	0.3016	460 000	0.3133	800 000	0.3181
600	0.2556	130 000	0.3023	470 000	0.3134	810 000	0.3182
700	0.2569	140 000	0.3029	480 000	0.3136	820 000	0.3183
800	0.2581	150 000	0.3035	490 000	0.3138	830 000	0.3184
900	0.2591	160 000	0.3041	500 000	0.3140	840 000	0.3185
1 000	0.2600	170 000	0.3046	510 000	0.3142	850 000	0.3186
2 000	0.2660	180 000	0.3051	520 000	0.3143	860 000	0.3187
3 000	0.2695	190 000	0.3056	530 000	0.3145	870 000	0.3188
4 000	0.2720	200 000	0.3060	540 000	0.3146	880 000	0.3189
5 000	0.2740	210 000	0.3064	550 000	0.3148	890 000	0.3190
6 000	0.2756	220 000	0.3068	560 000	0.3150	900 000	0.3191
7 000	0.2769	230 000	0.3072	570 000	0.3151	910 000	0.3192
8 000	0.2781	240 000	0.3076	580 000	0.3153	920 000	0.3193
9 000	0.2791	250 000	0.3080	590 000	0.3154	930 000	0.3194
10 000	0.2800	260 000	0.3083	600 000	0.3156	940 000	0.3195
15 000	0.2835	270 000	0.3086	610 000	0.3157	950 000	0.3196
20 000	0.2860	280 000	0.3089	620 000	0.3158	960 000	0.3196
25 000	0.2880	290 000	0.3092	630 000	0.3160	970 000	0.3197
30 000	0.2895	300 000	0.3095	640 000	0.3161	980 000	0.3198
35 000	0.2909	310 000	0.3098	650 000	0.3163	990 000	0.3199
40 000	0.2920	320 000	0.3101	660 000	0.3164	1 000 000	0.3200

Coefficients  $K_1$  or  $K_2$  at intermediate values of V or  $V_c$  shall be obtained by linear interpolation.

**LAWS OF TRINIDAD AND TOBAGO**

MINISTRY OF THE ATTORNEY GENERAL AND LEGAL AFFAIRS

www.legalaffairs.gov.tt

326

**Chap. 50:10**

*Shipping*

[Subsidiary]

*Shipping (Tonnage) Regulations*

**THIRD SCHEDULE**

**FORM 1**

**International Tonnage Certificate (1969)**

*Issued under the provisions of the*

**INTERNATIONAL CONVENTION ON TONNAGE  
MEASUREMENT OF SHIPS (1969)**

under the authority of the Government of the Republic of Trinidad and Tobago for which the Convention came into force on 18th July, 1982.

by .....

(full official designation of the competent person or organisation recognised under the provisions of the International Convention of Tonnage Measurement of Ships, 1969)

Name of Ship	Distinctive Number or Letters	Port of Registry	*Date

\*Date on which the keel was laid or the ship was at a similar stage of construction [Article 2(6)], or date on which the ship underwent alterations or modifications of a major character [Article 3(2) (b)], as appropriate.

**MAIN DIMENSIONS**

Length [Article 2(8)]	Breadth [Regulation 2(3)]	Moulded Depth amidships to Upper Deck [Regulation 2(2)]

UNOFFICIAL VERSION

UPDATED TO 31ST DECEMBER 2016

**THE TONNAGES OF THE SHIP ARE:**

GROSS TONNAGE .....

NET TONNAGE .....

This is to certify that the tonnages of this ship have been determined in accordance with the provisions of the International Convention of Tonnage Measurement of Ships, 1969.

Issued at ..... 20.....  
*place of issue of certificate*                      *date of issue*

.....  
*Signature of Official Issuing the Certificate*  
*and/or*

*Seal of Issuing Authority*

*If signed, the following paragraph is to be added:*

The undersigned declares that he is duly authorised by the said Government to issue this certificate.

.....  
*Signature*

**LAWS OF TRINIDAD AND TOBAGO**

MINISTRY OF THE ATTORNEY GENERAL AND LEGAL AFFAIRS

www.legalaffairs.gov.tt

328

**Chap. 50:10**

*Shipping*

**[Subsidiary]**

*Shipping (Tonnage) Regulations*

(Reverse side of the International Tonnage Certificate)

SPACES INCLUDED IN TONNAGE					
GROSS TONNAGE			NET TONNAGE		
Name of Space	Location	Length	Name of Space	Location	Length
Underdeck	—	—			
<b>EXCLUDED SPACES</b> [Regulation 2(5)] An asterisk (*) should be added to those spaces listed above which comprise both enclosed and excluded spaces.			<b>NUMBER OF PASSENGERS</b> [Regulation 4(1)] Number of passengers in cabins with not more than 8 berths ..... Number of other passengers.....		
			<b>MOULDED DRAUGHT</b> [Regulation 4(2)]		
Date and place of original measurement .....					
Date and place of last previous remeasurement .....					
REMARKS:					

UNOFFICIAL VERSION

UPDATED TO 31ST DECEMBER 2016

FORM 2

REPUBLIC OF TRINIDAD AND TOBAGO

TONNAGE CERTIFICATE FOR SHIPS NOT ASSIGNED  
A TONNAGE MARK

Name of Ship	Port of Registry		Official Number
Main Dimensions	Length	Breadth	Depth

I, the undersigned Surveyor appointed by the Minister hereby certify that I have measured the above ship in accordance with Rule of the Shipping (Tonnage) Regulations, 1988 and by this Rule the—

GROSS TONNAGE is ..... tons (..... cubic metres)  
and the NET REGISTER tonnage is ..... tons  
( ..... cubic metres).

A summary of the tonnages is given overleaf, together with an account of the spaces which have not been included in the above tonnages.

Examined by

Dated at .....

this ..... day of ..... 20.....

.....

Surveyor

NOTE: FOR TUGS. If and when employed for the carriage of passengers, cargo or stores, or using graving docks or dry docks or places provided for the repairing of vessels, the net or register tonnage applicable under these circumstances is to be endorsed on this certificate.

This certificate ceases to be valid if any alteration is made in the form or capacity of the ship or if it is discovered that the tonnage of the ship has been erroneously computed.

**LAWS OF TRINIDAD AND TOBAGO**

MINISTRY OF THE ATTORNEY GENERAL AND LEGAL AFFAIRS

www.legalaffairs.gov.tt

330

**Chap. 50:10**

*Shipping*

**[Subsidiary]**

*Shipping (Tonnage) Regulations*

**SUMMARY OF THE PARTICULARS OF TONNAGE**

Gross Tonnage	No. of Tons	Deductions Allowed	No. of Tons
Under tonnage deck ... ..		On account of space required for propelling power ...	
Space or spaces between decks		Master ... ..	
Turret or trunk ... ..		Crew Accommodation ...	
Forecastle ... ..		Navigational Spaces ... ..	
Bridge space ... ..		Safety Equipment ... ..	
Poop ... ..		Workshops and Storerooms ...	
Break ... ..		Donkey Engine and Boiler ...	
Side houses ... ..		Pump Rooms ... ..	
Deck houses ... ..		Sail Room ... ..	
Spaces for machinery and light and air, under paragraph 5(1)(e) of the Fourth Schedule to the Shipping (Tonnage) Regulations.		Water Ballast ... ..	
Excess of hatchways... ..			
GROSS TONNAGE	Cubic metres		
Deductions, as per contra			
Net/Register Tonnage		Total ...	
<p>The tonnage of the engine room spaces below the upper deck is .....tons.</p> <p>The tonnage of the total spaces framed in above the upper deck for propelling machinery and for light and air is ..... tons.</p>			

The undermentioned cargo spaces above the upper deck are not included in the above tonnages.

UNOFFICIAL VERSION

UPDATED TO 31ST DECEMBER 2016

**FORM 3**

REPUBLIC OF TRINIDAD AND TOBAGO

**TRINIDAD AND TOBAGO TONNAGE CERTIFICATE**

For ships to which a Tonnage mark has been assigned and which has alternative Tonnages

Name of Ship	Port of Registry		Official Number
Main Dimensions	Length	Breadth	Depth

I, the undersigned Surveyor appointed by the Minister, hereby certify that I have measured the above ship in accordance with Rule I of the Shipping (Tonnage) Regulations and by this Rule—

When the Tonnage Mark (or the appropriate line for freshwater and/or tropical waters) is submerged the—

GROSS TONNAGE is ..... tons ( ..... cubic metres) and the

NET/REGISTER TONNAGE is ..... tons ( ..... cubic metres)

When the Tonnage Mark (or the appropriate line for freshwater and/or tropical waters) is NOT submerged the—

GROSS TONNAGE is ..... tons ( ..... cubic metres) and the

NET/REGISTER TONNAGE is ..... tons ( ..... cubic metres)

A summary of the respective Tonnages is given overleaf, together with an account of the spaces which have not been included in the above Tonnages.

LAWS OF TRINIDAD AND TOBAGO

MINISTRY OF THE ATTORNEY GENERAL AND LEGAL AFFAIRS

www.legalaffairs.gov.tt

332

Chap. 50:10

Shipping

[Subsidiary]

Shipping (Tonnage) Regulations

The TONNAGE MARK is marked on each side of the ship as follows:

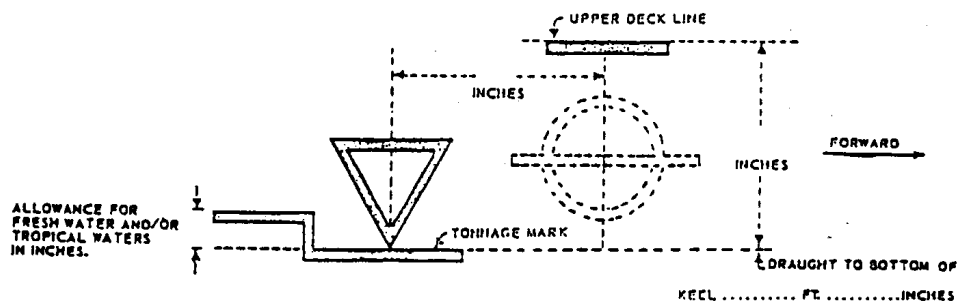

Dated at ..... this ..... day of

....., 20.....

.....  
*Examined by*

.....  
*Surveyor*

NOTE: This certificate ceases to be valid if any alteration is made in the form or capacity of the ship or if it is discovered that the tonnage of the ship has been erroneously computed.

UNOFFICIAL VERSION

UPDATED TO 31ST DECEMBER 2016

**SUMMARY OF THE PARTICULARS OF TONNAGE WHEN THE  
 TONNAGE MARK IS SUBMERGED**

Gross Tonnage	No. of Tons	Deductions Allowed	No. of Tons
Under tonnage deck ... ..		On account of space required for propelling power ...	
Space or spaces between decks		Master ... ..	
Turret or trunk ... ..		Crew Accommodation ...	
Forecastle ... ..		Navigational Spaces ... ..	
Bridge space ... ..		Safety Equipment ... ..	
Poop ... ..		Workshops and Storerooms ...	
Break ... ..		Donkey Engine and Boiler ...	
Side houses ... ..		Pump Rooms ... ..	
Deck houses ... ..		Sail Room ... ..	
Spaces for machinery and light and air under paragraph 5(1)(e) of the Fourth Schedule to the Shipping (Tonnage) Regulations.		Water Ballast ... ..	
Excess of hatchways... ..			
	Cubic metres		
<b>GROSS TONNAGE</b>			
Deductions, as per contra			
Net/Register Tonnage		Total ...	
<p>The tonnage of the engine room spaces below the upper deck is .....tons.</p> <p>The tonnage of the total spaces framed in above the upper deck for propelling machinery and for light and air is ..... tons.</p>			

The undermentioned cargo spaces above the upper deck are not included in the above tonnages.

**LAWS OF TRINIDAD AND TOBAGO**

MINISTRY OF THE ATTORNEY GENERAL AND LEGAL AFFAIRS

www.legalaffairs.gov.tt

334

**Chap. 50:10**

*Shipping*

**[Subsidiary]**

*Shipping (Tonnage) Regulations*

**SUMMARY OF THE PARTICULARS OF TONNAGE WHEN THE  
TONNAGE MARK IS NOT SUBMERGED**

Gross Tonnage		No. of Tons	Deductions Allowed	No. of Tons
Under tonnage deck ... ..	...		On account of space required for propelling power ...	
Space or spaces between decks			Master ... ..	
Turret or trunk ... ..	...		Crew Accommodation ...	
Forecastle ... ..	...		Navigational Spaces ... ..	
Bridge space ... ..	...		Safety Equipment ... ..	
Poop ... ..	...		Workshops and Storerooms ...	
Break ... ..	...		Donkey Engine and Boiler ...	
Side houses ... ..	...		Pump Rooms ... ..	
Deck houses ... ..	...		Sail Room ... ..	
Spaces for machinery and light and air, under paragraph 5(1)(e) of the Fourth Schedule to the Shipping (Tonnage) Regulations.			Water Ballast ... ..	
Excess of hatchways... ..	...			
	Cubic metres			
<b>GROSS TONNAGE</b>				
Deductions, as per contra				
Net/Register Tonnage			Total ... ..	
<p>The tonnage of the engine room spaces below the upper deck is .....tons.</p> <p>The tonnage of the total spaces framed in above the upper deck for propelling machinery and for light and air is ..... tons.</p>				

The undermentioned cargo spaces above the upper deck are not included in the above tonnages.

UNOFFICIAL VERSION

UPDATED TO 31ST DECEMBER 2016

**FORM 4**

REPUBLIC OF TRINIDAD AND TOBAGO

**TRINIDAD AND TOBAGO TONNAGE CERTIFICATE**

For ships on which a Tonnage mark has been placed corresponding to load line marks which have been assigned on the assumption that the second deck is the freeboard deck and which does not therefor have alternative Tonnages

Name of Ship	Port of Registry		Official Number
Main Dimensions	Length	Breadth	Depth

I, the undersigned Surveyor appointed by the Minister, hereby certify that I have measured the above ship in accordance with Rule I of the Shipping (Tonnage) Regulations, 1988 and by this Rule the —

GROSS TONNAGE is ..... tons ( ..... cubic metres) and the

NET/REGISTER TONNAGE is ..... tons ( ..... cubic metres).

A summary of the Tonnages is given overleaf, together with an account of the spaces which have not been included in the above Tonnages.

LAWS OF TRINIDAD AND TOBAGO

MINISTRY OF THE ATTORNEY GENERAL AND LEGAL AFFAIRS

www.legalaffairs.gov.tt

336

Chap. 50:10

Shipping

[Subsidiary]

Shipping (Tonnage) Regulations

The TONNAGE MARK is marked on each side of the ship as follows:

The tonnage mark is in line with the deepest loading permitted by the load line grid, and is only an identification mark to indicate that certain spaces between the second and upper decks as indicated overleaf have not been included in the above tonnages.

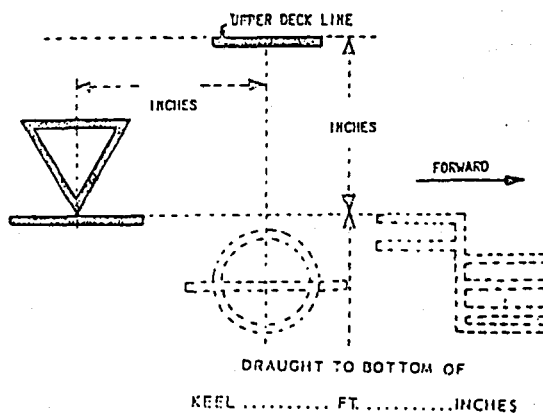

Dated at ..... this ..... day of ....., 20.....

.....  
*Examined by*

.....  
*Surveyor*

NOTE: This certificate ceases to be valid if any alteration is made in the form or capacity of the ship or if it is discovered that the tonnage of the ship has been erroneously computed.

UNOFFICIAL VERSION

UPDATED TO 31ST DECEMBER 2016

**SUMMARY OF THE PARTICULARS OF TONNAGE**

Gross Tonnage	No. of Tons	Deductions Allowed	No. of Tons
Under tonnage deck ... ..		On account of space required for propelling power ...	
Space or spaces between decks		Master ... ..	
Turret or trunk ... ..		Crew Accommodation ...	
Forecastle ... ..		Navigational Spaces ... ..	
Bridge space ... ..		Safety Equipment ... ..	
Poop ... ..		Workshops and Storerooms ...	
Break ... ..		Donkey Engine and Boiler ...	
Side houses ... ..		Pump Rooms ... ..	
Deck houses ... ..		Sail Room ... ..	
Spaces for machinery and light and air, under paragraph 5(1)(e) of the Fourth Schedule to the Shipping (Tonnage) Regulations.		Water Ballast ... ..	
Excess of hatchways... ..			
	Cubic metres		
<b>GROSS TONNAGE</b>			
Deductions, as per contra			
Net/Register Tonnage		Total ... ..	
<p>The tonnage of the engine room spaces below the upper deck is .....tons.</p> <p>The tonnage of the total spaces framed in above the upper deck for propelling machinery and for light and air is ..... tons.</p>			

The undermentioned cargo spaces above the upper deck are not included in the above tonnages.

## FOURTH SCHEDULE

PROVISION APPLICABLE TO THE TONNAGE OF  
CERTAIN SHIPS REFERRED TO IN PARTS III, IV, V  
AND VI OF THE REGULATIONS

## PART A

## DEFINITIONS

## Definitions.

1. In addition to the definitions prescribed in regulation 2, in this Schedule and in Appendices A to E hereto, unless the context otherwise requires—

“crew accommodation” has the same meaning as in section 147(6) of the Shipping Act;

“dry cargo space” means space appropriated for the carriage of cargo other than liquid or gaseous matter in bulk;

“overall length” in relation to a pleasure craft to which Part F of this Schedule applies means the distance between the foreside of the foremost fixed permanent structure and the aftside of the aftermost fixed permanent structure of the craft;

“propelling machinery space” means the space below the upper deck appropriated for the main or auxiliary propelling machinery of a ship, and includes—

- (a) ventilation, light or escape trunks serving any such space;
- (b) space appropriated for boilers serving such machinery;
- (c) shaft tunnels;
- (d) engineers’ storerooms and workshops not exceeding in total tonnage three-quarters of one per cent of the gross tonnage of the ship;
- (e) oil fuel settling tanks serving the main or auxiliary propelling machinery, having a total capacity sufficient to provide not less than twenty-four or more than ninety-six hours steaming for the ship at maximum speed,

and shall also include framed-in spaces on or above the upper deck described in paragraph 5(1)(e) and included in the gross tonnage of the ship in accordance with that provision;

“second deck” means the deck next below the upper deck, being a deck—

- (a) which is fitted as an integral part of the ship’s structure;
- (b) which is continuous at least between peak bulkheads both fore and aft and transversely; and

- (c) in which all hatchways are fitted with substantial and durable covers, a deck being taken to be continuous for this purpose notwithstanding the presence in it of—
- (i) openings serving propelling machinery space or leading to ladder-ways or stairways;
  - (ii) hatch or ventilation trunks, provided that they do not extend fore and aft from one main transverse bulkhead to another;
  - (iii) chain lockers or cofferdams; or
  - (iv) a break or breaks the aggregate height of which above the line of continuation of the deck does not exceed four feet;

“tonnage deck” means the second deck except in the case of single deck ships, in which case it means the upper deck;

“upper deck” for the purposes of this Schedule means the uppermost complete deck exposed to sea and weather fitted as an integral part of the ship’s structure, being a deck all openings in the weather portions of which are fitted with permanent means of closing and below which all openings in the sides of the ship are fitted with permanent means of watertight closing, but shall in the case of an open ship be taken to the upper edge of the upper strake of the gunwale.

## PART B

### TONNAGES GENERAL

2. The tonnage of any ship to which Parts III and IV of these Regulations and this Schedule applies and which is to be registered in Trinidad and Tobago under Part III of the Act shall be ascertained in accordance with this Schedule save that in the case of novel types of craft with constructional features which render the application of the provisions of this Schedule unreasonable or impracticable the tonnage shall be determined as required by the Minister.

Ascertainment of tonnage.

3. (1) The owner and the master of a ship to be measured shall upon payment of the appropriate fee make it available for measurement by a surveyor and afford all necessary facilities for its inspection and measurement and shall produce for the surveyor’s use and retention if required such plans, drawings, specification and other documents relating to the ship as he may require.

Method of measurement.

(2) Subject to subparagraph (3), the tonnage of a ship shall be measured in the manner specified in Rule I of Appendix A and in Appendix B to this Schedule.

**LAWS OF TRINIDAD AND TOBAGO**

MINISTRY OF THE ATTORNEY GENERAL AND LEGAL AFFAIRS

www.legalaffairs.gov.tt

340

**Chap. 50:10**

*Shipping*

[Subsidiary]

*Shipping (Tonnage) Regulations*

(3) In any case in which the surveyor is satisfied that by reason of a ship being laden or otherwise, measurement of the tonnage of the ship below the upper deck in accordance with subparagraph (2) is not reasonably practicable such tonnage shall be measured in the manner specified in Rule II of Appendix A and in the case of a ship so measured the provisions of paragraphs 13 and 14 shall not apply.

(4) The Certifying Authority may on the application of the owner of any ship the tonnage of which below the upper deck has been measured in accordance with subparagraph (3) direct such tonnage to be measured in accordance with subparagraph (2) and furnish the particulars of such measurement to the Registrar of Ships and the Registrar shall alter the particulars relating to the registered tonnage of the ship accordingly.

(5) All measurements required by this Schedule shall be taken and expressed in feet and decimals of a foot.

(6) Tonnage in relation to any ship or space in a ship shall be measured in terms of cubic capacity with one hundred cubic feet representing one ton and expressed in tons and hundredths of a ton.

Certificates of  
Trinidad and  
Tobago tonnage.

4. (1) The Certifying Authority shall issue to the owner of every ship registered in Trinidad and Tobago under the Act, the tonnage of which has been ascertained in accordance with this Schedule, a certificate of Trinidad and Tobago tonnage certifying the registered tonnage of the ship and containing the following particulars:

- (a) the name, port of registry and official number of the ship;
- (b) its main dimensions;
- (c) its gross tonnage and the tonnage of each of the components thereof specified in paragraph 5(1);
- (d) its register tonnage and the deductions and allowances made pursuant to paragraphs 11 and 12 respectively in ascertaining that tonnage;
- (e) in the case of a ship to which gross and register tonnages have been assigned in accordance with paragraph 13 or to which alternative tonnages have been assigned in accordance with paragraph 14 particulars of the spaces the tonnage of which has been excluded by virtue of the provisions of paragraph 13 or 14, as the case may be, in ascertaining such tonnages;

UNOFFICIAL VERSION

UPDATED TO 31ST DECEMBER 2016

(f) the position in which any tonnage mark assigned to the ship is to be placed.

(2) The gross and register tonnages as stated in that certificate shall, unless any alteration is made in the form or capacity of the ship or it is discovered that the tonnage of the ship has been erroneously computed, be taken for that purpose to be the gross and register tonnages of the ship.

(3) On remeasurement of a ship any certificate of Trinidad and Tobago tonnage in force in relation to that ship shall be delivered up to the Certifying Authority and the Certifying Authority shall issue a new certificate in place thereof.

### PART C

### GROSS TONNAGE

5. (1) Subject to the provisions of Part E of this Schedule, the gross tonnage of a ship shall be the sum of— Components of gross tonnage.

- (a) the underdeck tonnage of the ship ascertained in accordance with the provisions of paragraph I of Rule I of Appendix A to this Schedule;
- (b) the tonnage of between deck space between the second deck and the upper deck ascertained in accordance with the provisions of paragraph 2 of Rule I of Appendix A to this Schedule;
- (c) the tonnage of permanently closed-in spaces on or above the upper deck including that of breaks situated above the line of the deck but excluding—
  - (i) the tonnage of hatchways described in paragraph 7;
  - (ii) the tonnage of framed-in spaces on or above the upper deck which contain any part of the propelling machinery or which light or ventilate space appropriated for such machinery;
  - (iii) any space excluded by virtue of the provisions of paragraph 8, ascertained in accordance with the provisions of paragraphs 3, 4 and 5 of Rule I of Appendix A to this Schedule;
- (d) the tonnage of hatchways described in paragraph 7, ascertained in accordance with the provisions of that paragraph and paragraph 5 of Rule I of Appendix A to this Schedule;
- (e) the tonnage of framed-in spaces on or above the upper deck which contain any part of the propelling machinery or which light or ventilate space appropriated for such machinery,

ascertained in accordance with the provisions of paragraph 5 of Rule I of Appendix A to this Schedule subject to the conditions that—

- (i) the owner of a ship has made written application to the certifying authority for the inclusion of such spaces in the propelling machinery space of the ship;
- (ii) they are permanently marked by notice stating their purpose; and
- (iii) they are certified by a surveyor as safe and seaworthy and properly constructed for their purpose, as reasonable in extent for that purpose, and as being such that they cannot be used for any other purpose.

(2) In the case of a ship the tonnage of which below the upper deck has been measured in accordance with Rule II of Appendix A, that tonnage shall be included instead of the tonnages specified in subparagraph (1)(a) and (b) of paragraph 5 of this Schedule.

(3) For the purpose of this Schedule and Appendices A to E hereto the expression permanently closed-in spaces on or above the upper deck includes—

- (a) a poop, bridge or forecastle notwithstanding the presence of an opening in the end transverse bulkhead thereof, unless the opening extends from deck to deck or one-half or more of the breadth of the deck in way of the bulkhead;
- (b) a deck house notwithstanding the presence of an opening in one of the boundary bulkheads thereof exposed to the weather, unless the opening extends from deck to deck for one-half or more of the length of the bulkhead in which it is situated and is four feet wide or more;
- (c) a structure extending from side to side of the ship notwithstanding the presence in it of an opening in the ship's side, unless the opening extends for one-half or more of the length of the space which it serves and exceeds in height one-third of the distance from deck to deck in way of the opening or two feet and six inches whichever is the greater;
- (d) a passage way at the ship's side, unless it is four feet wide or more and is completely open to the weather at one end, or both ends, of its length;
- (e) a recess, unless it extends from deck to deck for three feet or more of its width and is exposed to the weather; and
- (f) any space having an opening in the deck over it being a deck exposed to the weather, unless the area of the opening is one-quarter or more of the deck area over the space.

6. The underdeck tonnage of a ship shall be the sum of—
- Underdeck  
tonnage.
- (a) the tonnage of the space below the tonnage deck bounded by—
    - (i) the tonnage deck;
    - (ii) the upper surface of the double bottom tanks open floors or ceiling as the case may be; and
    - (iii) the inner face of the timbers, frames or sparring as the case may be, measured in accordance with the provisions of paragraph I of Rule I of Appendix A to this Schedule, but subject to such limitations specified in Appendix B hereto as may be applicable in the circumstances of the case, and excluding the tonnage of breaks above the line of the tonnage deck; and
  - (b) the tonnage of shaft bossings and any other appendages forming part of the hull of the ship below the tonnage deck whether or not they project beyond the extreme points of measurement of that deck.

7. The tonnage of all hatchways leading to space included in the gross tonnage of the ship other than internal hatchways totally enclosed within such space shall be measured in accordance with paragraph 5 of Rule I of Appendix A to this Schedule and from the aggregate thereof there shall be deducted one-half of one per cent of the ship's gross tonnage excluding such aggregate. The remainder, if any, shall be the tonnage of hatchways, customarily referred to as "excess of hatchways", to be included in the gross tonnage of the ship.

Tonnage of  
hatchways.

8. Permanently closed-in spaces of the following kinds situated on or above the upper deck shall not be included in the gross tonnage of the ship:
- Closed-in  
spaces on or  
above the upper  
deck not to be  
included in  
gross tonnage.
- (a) dry cargo space, unless situated in a break above the line of the upper deck;
  - (b) space fitted with and appropriated for the use of machinery or condensers;
  - (c) the wheelhouse and chartroom, and space fitted with and appropriated for the use of radio and navigational aids;
  - (d) skylights, domes and trunks which light or ventilate the space they serve;
  - (e) chain lockers, and space appropriated for working the anchor gear and capstan;
  - (f) space appropriated for the storage of safety equipment or batteries;

- (g) companions and access hatches serving as protection for stairways or ladderways leading to space below, and openings over such stairways and ladderways;
- (h) the galley, and any separate bakery fitted with ovens, provided in either case that no part thereof is appropriated for use for any other purpose;
- (i) washing and sanitary accommodation forming part of the crew accommodation or appropriated for the use of the master;
- (j) workshops and storerooms appropriated for the use of pumpmen, engineers, electricians, carpenters and boatswains, and the lamp-room;
- (k) water ballast tanks not appropriated for use for any other purpose;
- (l) shelter space providing weather protection only for use, free of charge, by deck passengers in ships intended for use only on voyages not exceeding ten hours duration;
- (m) sheltered promenade space, glassed in and unfurnished except for deckchairs or similar light portable seating, in ships intended for use on international voyages.

However, this paragraph shall not apply in any case save that specified in subparagraph (a) unless the space is certified by a surveyor as being reasonable in extent, and properly constructed, for its purpose and is permanently marked by a notice stating that purpose.

Application.

9. (1) Subparagraph (2) applies—

- (a) to ships previously registered elsewhere which are to be registered in Trinidad and Tobago; and
- (b) to ships registered in a foreign State in respect of which application is made for a Certificate of Trinidad and Tobago tonnage pursuant to regulation 15(4).

(2) Without prejudice to the provisions of paragraph 8, space situated on or above the upper deck of a ship to which, this paragraph applies, being space which, in the case of a ship described in subparagraph (1)(a) or (b), was, by virtue of there being or having been openings in it not included in the gross tonnages of the ship specified in the national certificate of registry in force in respect of the ship immediately prior to her registry in Trinidad and Tobago, or the said application, as the case may be, shall not be included in the gross tonnage of the ship irrespective of whether such openings have been closed or not unless there has been no change, since the date on which the tonnage of the ship was last measured, in the purpose for which the space is used.

**PART D**

**REGISTER TONNAGE**

10. Subject to the provisions of Part E of this Schedule, the register tonnage of a ship shall be the tonnage obtained by deducting from its gross tonnage— Ascertainment of register tonnage.

- (a) the tonnage of spaces specified in paragraph 11; and
- (b) the tonnage allowance for propelling machinery space described in paragraph 12 save that—
  - (i) the deduction shall in each case be subject to any condition, limit or restriction expressed to be applicable in that case; and
  - (ii) no deduction shall be made of or in respect of the tonnage of any space which has not first been included in the ship's gross tonnage.

11. The spaces referred to in paragraph 10(a) are—

Space to be deducted.

- (a) space appropriated for the accommodation of the master;
- (b) crew accommodation, except space appropriated for the storage of fresh water and space appropriated for the storage of provisions, other than fresh water, being in the latter case space in excess of fifteen per cent, of the aggregate of—
  - (i) space appropriated for the accommodation of the master; and
  - (ii) crew accommodation other than space appropriated for the storage of provisions and fresh water;
- (c) the wheelhouse and chartroom, and space fitted with and appropriated for the use of radio and navigational aids;
- (d) chain lockers and space appropriated for, or for the working of, the steering gear, anchor gear and capstan;
- (e) space appropriated for the storage of safety equipment or batteries;
- (f) workshops and storerooms appropriated for the use of pumpmen, electricians, carpenters and boatswains, and the lamp-room;
- (g) space occupied by the donkey engine and boiler if they are outside the propelling machinery space and connected to the main pumps of the ship;
- (h) space occupied by the main pumps of the ship if they are outside the propelling machinery space;

- (i) in the case of ships wholly propelled by sails, space appropriated for the storage of sails, so however that the total tonnage of such space does not exceed two and one-half per cent of the ship's gross tonnage; and
- (j) water ballast tanks not appropriated for use for any other purpose, so however that the total tonnage to be so deducted, when added to the tonnage of spaces appropriated for water ballast not included in the gross tonnage of the ship consisting of double bottom space, space below bottom floor level or space above the upper deck, does not exceed nineteen per cent of the ship's gross tonnage save that no deduction shall be made in respect of—
  - (i) any space specified in subparagraph (b) unless it is certified by a surveyor as complying with all applicable provisions as to crew accommodation contained in the Shipping Act, Ch. 50:10 and Regulations made thereunder; and
  - (ii) any space specified in subparagraphs (a), or (c) to (j), unless it is certified by a surveyor to be reasonable in extent, properly constructed for its purpose and is permanently marked by a notice stating that purpose.

Allowance for propelling machinery space.

12. The tonnage allowance for propelling machinery space to be deducted pursuant to paragraph 10(b) shall be determined as follows:

- (a) in the case of ships propelled by screws—
  - (i) where the tonnage of the propelling machinery space is thirteen per cent or over but less than twenty per cent of the gross tonnage, the allowance shall be thirty-two per cent of the gross tonnage;
  - (ii) where the tonnage of the propelling machinery space is less than thirteen per cent of the gross tonnage, the allowance shall be that lesser percentage of the gross tonnage multiplied by thirty-two and then divided by thirteen;
- (b) in the case of ships to which subparagraph (a) does not apply, the allowance shall be one and three-quarter times the tonnage of the propelling machinery space, save that—
  - (i) except in the case of tugs intended to be used exclusively as such, the allowance shall not exceed fifty-five per cent of that portion of the tonnage of the ship which

remains after deducting from its gross tonnage the deductions authorised by paragraph 10(a); and

- (ii) such deductions shall be subject to the propelling machinery space and space appropriated for its lighting and ventilation being certified as adequate by a surveyor and being permanently marked by notices stating their purpose.

**PART E**

**MODIFIED AND ALTERNATIVE TONNAGES AND  
TONNAGE MARKS**

13. (1) This article shall apply to a ship in respect of which greater than minimum freeboards have been assigned under the Load Line Regulations and where the positions of the load lines are—

Modified gross and register tonnage of ships with certain freeboards.

- (a) not higher than would have been the case if the freeboards assigned to the ship and the position of the load lines appropriate thereto had been calculated treating the second deck as the freeboards deck; or
- (b) such that the uppermost load line is not higher than the position of the tonnage mark determined in accordance with Appendix D to this Schedule.

(2) The Certifying Authority may, on the application of the owner of a ship to which this paragraph applies, assign to the ship as its gross tonnage and register tonnage a modified gross tonnage and modified register tonnage ascertained in accordance with subparagraph (3) instead of the gross tonnage and register tonnage ascertained in accordance with Parts C and D of this Schedule.

(3) The modified gross tonnage and modified register tonnage to be so assigned shall be ascertained in accordance with Parts C and D of this Schedule subject to the following modifications:

- (a) in subparagraph 5(1)(c), 5(1)(e) and 5(3), paragraph 8 and subparagraphs 9(2) and 11(j) and in the definition of propelling machinery space in this Schedule, and in paragraphs 3, 5 and 6 of Rule I of Appendix A hereto, references to the upper deck shall be substituted by references to the second deck; and
- (b) paragraph 5(1)(b) of this Schedule and paragraph 2 of Rule I of Appendix A shall be omitted.

**LAWS OF TRINIDAD AND TOBAGO**

MINISTRY OF THE ATTORNEY GENERAL AND LEGAL AFFAIRS

www.legalaffairs.gov.tt

348

**Chap. 50:10**

*Shipping*

[Subsidiary]

*Shipping (Tonnage) Regulations*

(4) Where such tonnages have been assigned to a ship there shall be placed on each side of the ship a tonnage mark in the form described in Appendix C to this Schedule, in a position in line with the uppermost load line to which the ship may be loaded but, subject to the foregoing, in a position determined in accordance with Appendix D.

Alternative gross and register tonnages.

14. (1) The Certifying Authority, may, on the application of the owner of a ship, assign to the ship, as an alternative to its gross tonnage and register tonnage ascertained in accordance with Parts C and D of this Schedule, the modified gross tonnage and modified register tonnage ascertained in accordance with the provisions of paragraph 13(3).

(2) Where alternative tonnages have been assigned to a ship there shall be placed on each side of that ship a tonnage mark in the form described in Appendix C to this Schedule in a position determined in accordance with the provisions of Appendix D hereto.

(3) The gross tonnage and register tonnage of the ship shall be taken to be respectively the modified gross tonnage and modified register tonnage when the ship is so loaded that the tonnage mark is not submerged and at all other times the gross and register tonnages of the ship shall be those ascertained in accordance with Parts C and D of this Schedule.

**PART F**

**PLEASURE CRAFT UNDER FORTY-FIVE FEET  
IN LENGTH**

Application.

15. (1) This Part of this Schedule applies only in relation to pleasure craft under forty-five feet (13.7 metres) in overall length which are to be registered in Trinidad and Tobago under Part III of the Act.

(2) Parts B, C, D and E of this Schedule shall not apply in relation to pleasure craft to which this Part of this Schedule applies.

Ascertainment of tonnage.

16. The tonnage of a pleasure craft to which this Part of this Schedule applies shall be ascertained in accordance with paragraph 17 and the tonnage so ascertained shall be taken to be its gross and register tonnage.

Availability for measurement.

17. (1) The owner of such a pleasure craft to be measured shall make it available for measurement, pursuant to section 22 of the Shipping Act, by a surveyor appointed by the Certifying Authority and shall afford all necessary facilities for its inspection and measurement and shall produce for the surveyor's use and retention, if required, such plans, drawings, specifications and other documents relating to the pleasure craft as may be required.

UNOFFICIAL VERSION

UPDATED TO 31ST DECEMBER 2016

(2) The tonnage of a pleasure craft to which this part of this Schedule applies shall be measured in the manner specified in Appendix E to this Schedule.

**PART G**

**SPACES NOT INCLUDED IN THE REGISTER TONNAGE  
WHICH ARE OCCUPIED BY CARGO**

18. Spaces not included in the register tonnage of a ship, referred to in section 22(2)(d) of the Shipping Act, including uncovered spaces on deck occupied by cargo, shall subject to paragraph 19, be measured in accordance with the method provided in paragraph 5 of Rule I of Appendix A to this Schedule. Method of measurement.

19. Where—

- (a) a ship has been assigned alternative tonnages in pursuance of paragraph 14; and
- (b) the tonnages applicable to the ship are the modified tonnages ascertained in accordance with paragraph 13(3),

Alternative and modified tonnages.

no account shall be taken for the purposes of the said section 22(2)(d) of the Shipping Act, of any space, which is included in the register tonnage ascertained in accordance with Part D of this Schedule but which is not included in the modified register tonnage, to the extent that the tonnage of such space exceeds the difference between those register tonnages.

20. Goods or stores shall not be carried in any permanently closed in space on board the ship which has not been included in the register tonnage of the ship other than— Restrictions.

- (a) dry cargo spaces;
- (b) workshops or storerooms appropriated for the use of pumpmen, engineers, electricians, carpenters and boatswains;
- (c) the lamp room; or
- (d) double bottom tanks.

## APPENDIX A

## RULES FOR MEASUREMENT OF TONNAGE

## RULE I

## MEASUREMENT OF TONNAGE-GENERAL

Underdeck  
tonnage.

1. (1) The length of the tonnage deck shall be measured by a straight line in the middle plane of the ship between the points at the forward and after ends of the deck where the underside of the deck, or the line of continuation thereof in way of breaks or discontinuations of the deck, meets the inner face of the frames, timbers, ceiling or sparring as the case may be, such length so measured being hereafter referred to in this Appendix and in Appendix B as the "tonnage length".

(2) In ships which have a break, or breaks, in a double bottom the tonnage length shall be measured in parts corresponding to the number and position of such break or breaks.

(3) The tonnage length, or the length of each of the several parts thereof obtained in accordance with subparagraph (2), shall be divided into equal parts as follows:

- (a) where the length is fifty feet or under, into four equal parts;
- (b) where the length is above fifty feet but not exceeding one hundred and twenty feet, into six equal parts;
- (c) where the length is above one hundred and twenty feet but not exceeding one hundred and eighty feet, into eight equal parts;
- (d) where the length is above one hundred and eighty feet but not exceeding two hundred and twenty-five feet, into ten equal parts;
- (e) where the length is above two hundred and twenty-five feet, into twelve equal parts,

save that the length of any of the several parts obtained in accordance with subparagraph (2) may be divided into two equal parts where such length is thirty feet or under.

(4) The transverse area of the ship at each point of division of the tonnage length, or of parts of that length as aforesaid, shall be calculated as follows:

- (a) the depth in the middle plane of the ship from the underside of the tonnage deck to the top of the open floor or double bottom as the case may be shall be measured, deducting therefrom the average thickness of ceiling, if fitted and one-third the round of beam;

- (b) in measuring the depth under subparagraph (4)(a) where the top of the double bottom falls from the middle plane of the ship, there shall be added to the depth the mean of the fall;
- (c) in measuring the depth under subparagraph (4)(a), where the top of the double bottom rises from the middle plane, a corresponding correction shall be deducted from the depth;
- (d) in ships of wooden construction the lower terminal point of the depth shall be the upper side of the floor timber at the inside of the limber strake, after deducting therefrom the average thickness of ceiling between the bilge planks and the limber strake;
- (e) where the depth so obtained does not exceed sixteen feet at the amidship division of the total tonnage length, the depth at each point of division of the tonnage length, or of parts of that length as aforesaid, shall be divided into four equal parts with depths in excess of sixteen feet being divided into six equal parts;
- (f) at the point of division between each of the parts obtained in accordance with subparagraph (4)(e) the horizontal breadths to the inner face of the timber, frame or sparring as the case may be shall be measured; numbering these breadths from the tonnage deck, the even numbered breadths shall be multiplied by four and the others, with the exception of the first and last, by two; these products shall be added together, and to the sum, there shall be added the first and last breadths; the quantity thus obtained shall be multiplied by one-third of the common interval between the breadths and the product shall be the transverse area in square feet.

(5) The transverse areas so obtained shall be numbered from the extreme forward point of measurement of the tonnage length, or of the parts thereof as the case may be; the even numbered areas shall be multiplied by four and the odd numbered areas, other than the first and last, by two, these products shall be added together and to the sum there shall be added the area, if any, of the first and last; the quantity thus obtained shall be multiplied by one-third of the common interval between the areas; the product so obtained divided by one hundred shall be the underdeck tonnage of the ship exclusive of the tonnage of spaces to be included therein pursuant to paragraph 6(b) in Part C of this Schedule (appendages).

2. (1) The betweendeck space between the second deck and the upper deck shall be measured for length in a straight line in the middle plane of the ship between the points at the forward and after ends of the space where the inner surface of the frames, timbers ceiling or sparring as the case may be

Betweendeck space between the second deck and the upper deck.

LAWS OF TRINIDAD AND TOBAGO

MINISTRY OF THE ATTORNEY GENERAL AND LEGAL AFFAIRS

www.legalaffairs.gov.tt

352

Chap. 50:10

Shipping

[Subsidiary]

Shipping (Tonnage) Regulations

meets the middle plane of the ship at half the height between the upper surface of the deck and the underside of the deck over.

(2) In measuring the betweendeck space under subparagraph (1) where a break exists in the second deck or the upper deck the line of the deck shall be extended through the break parallel to the raised part of the break; and the tonnage of the betweendeck space shall be measured in such case by reference to the line of the deck so extended.

(3) The length shall be divided into equal parts as provided in paragraph 1(3) of this rule. At each of these points of division the horizontal breadth from the inner face of the frames, timbers or sparring, as the case may be, shall be measured at half the height of the betweendeck space.

(4) These breadths shall be numbered from the stem, the stem being number 1. The even numbered breadths shall be multiplied by four and the odd number, other than the first and last, by two. The products shall be added together and the first and the last breadths shall be added to the sum. The quantity thus obtained shall be multiplied by one-third of the common interval between the breadths, and the areas thus obtained shall be multiplied by the mean height between the upper surface of the deck and the underside of the deck over. The product so obtained divided by one hundred shall be the tonnage of the betweendeck space.

Breaks in the upper deck.

3. Breaks in the upper deck shall be measured for length in a straight line in the middle plane of the ship between the extremities of the break at half the height of the break, terminal points at the stem or stern being taken as described in paragraph 2(1) of this rule; the length so obtained shall be divided into two equal parts for lengths of fifty feet or less, four equal parts for lengths above fifty feet but not more than two hundred and twenty-five feet and six equal parts for lengths over two hundred and twenty-five feet; at each of the points of division the horizontal breadth at half the height of the break at the ship's side to the inner face of the frames, timbers or sparring as the case may be shall be measured; numbering these breadths from the foremost terminal point, the even numbered breadths shall be multiplied by four and the odd numbered, other than the first and last, by two; the products shall be added together and to the sum there shall be added the first and last breadths; the quantity thus obtained shall be multiplied by one-third of the common interval between the breadths; the area thus obtained shall be multiplied by the height of the break; the product divided by one hundred shall be the tonnage of the break.

Poop, bridge and forecastle.

4. A poop, bridge or forecastle shall be measured as follows:

The mean length thereof shall be measured at half the height between the upper surface of the deck and the underside of the deck over, terminal points at the stem and stern being taken as described in

UNOFFICIAL VERSION

UPDATED TO 31ST DECEMBER 2016

paragraph 2(1) of this rule; the length so obtained shall be divided into two equal parts for length of fifty feet or under, four equal parts for lengths over fifty feet but not exceeding two hundred and twenty-five feet and six equal parts for lengths exceeding two hundred and twenty-five feet; at each of the points of division the horizontal breadth shall be measured from the inner face of the frames, timbers or sparring as the case may be at half the height between the upper surface of the deck and underside of the deck over; numbering these breadths from the foremost terminal point, the even numbered breadths shall be multiplied by four and the odd numbered, other than the first and last, by two; the products shall be added together and to the sum there shall be added the first and last breadths; the quantity thus obtained shall be multiplied by one-third of the common interval between the breadths and the area thus obtained shall be multiplied by the mean height of the poop, bridge or forecastle; the product divided by one hundred shall be the tonnage of the poop, bridge or forecastle.

5. Permanently closed-in spaces on or above the upper deck other than those dealt with in paragraph 4 shall be measured by ascertaining their mean length, breadth and height and the product of multiplying these dimensions together shall, when divided by one hundred, be the tonnage of the space.

Other permanently closed-in spaces on or above the upper deck.

6. (1) Propelling machinery space which extends to the ship's side and is situated below the upper deck shall be measured as follows:

Propelling machinery space.

The mean length shall be measured in each space at half the mean depth, which shall be measured in the middle plane of the ship from the underside of the deck forming the crown of the space to the top of the double bottom or open floor, allowance being made for a ceiling, if fitted; for amidship spaces three equally spaced breadths shall be used and for spaces abaft amidships three equally spaced breadths shall be used for length up to thirty feet, five equally spaced breadths for lengths over thirty feet to fifty feet and seven equally spaced breadths for lengths over fifty feet, the breadths being measured from the inner face of the frames, timbers or sparring as the case may be at half the depth of the space at that point; the mean length, mean breadth and mean depth so ascertained shall be multiplied together and the product divided by one hundred shall be the tonnage of the space.

(2) Propelling machinery space which does not extend to the ship's side and is situated below the upper deck shall be measured by ascertaining its mean length, mean breadth and mean depth, and the product of multiplying these dimensions together shall, when divided by one hundred be the tonnage of the space.

LAWS OF TRINIDAD AND TOBAGO

MINISTRY OF THE ATTORNEY GENERAL AND LEGAL AFFAIRS

www.legalaffairs.gov.tt

354

Chap. 50:10

Shipping

[Subsidiary]

Shipping (Tonnage) Regulations

Shaft bossings  
and appendages.

7. The tonnage of shaft bossings and other appendages referred to in paragraph 6(b) in Part C of this Schedule shall be ascertained by measuring the internal cubic capacity of the space as accurately as practicable and dividing the result by one hundred.

RULE II

MEASUREMENT OF TONNAGE BELOW THE UPPER  
DECK WHERE MEASUREMENT IN ACCORDANCE  
WITH RULE I IS IMPRACTICABLE

Method of  
measurement.

1. The length of the ship shall be measured on the upper side of the upper deck from the inside of the outer plate or plank at the stem to the aft side of the stern-post, or to the fore side of the rudder stock where no stern-post is fitted; the extreme breadth of the ship shall be measured, excluding rubbers or fenders; the girth, from the upper edge of the upper deck at side on one side of the ship to the same point at other side, shall be measured on the outside of the ship at the greatest breadth; to half the girth thus measured there shall be added half the aforesaid breadth; the square of the sum shall be multiplied by the aforesaid length; this product multiplied by .0017 in the case of ships built of wood and by .0018 in the case of other ships shall be the tonnage of the ship below the upper deck.

Measurement  
of girth  
where its  
ascertainment  
under  
paragraph 1 is  
not practicable.

2. In any case in which the surveyor is satisfied that by reason of the size of the ship it is not reasonably practicable to measure its girth as provided in paragraph 1, such girth shall be ascertained by adding the aforesaid breadth of the ship to twice the depth of the ship from the top of the upper deck at the side of the ship to the bottom of the keel and multiplying this sum by 0.98.

---

UNOFFICIAL VERSION

UPDATED TO 31ST DECEMBER 2016

**APPENDIX B**

**LIMITATION OF HEIGHT OF OPEN FLOORS AND  
DOUBLE BOTTOMS, AND OF DEPTHS OF FRAMES  
AND SIDE BRACKETS FOR PURPOSES OF  
MEASUREMENT OF UNDERDECK TONNAGE**

(The provisions of this Appendix shall have effect for the purposes of  
the measurement of underdeck tonnage)

1. (1) Any part of an open floor, other than a floor in the main space of the propelling machinery of a ship, which is situated above the horizontal line hereinafter described shall be disregarded for the purposes of measurement of underdeck tonnage, which shall be measured accordingly by reference to the said line. Open floors.

(2) The line above referred to shall be a line passing through a point in the middle plane of the ship at a height consisting of the maximum height of open floors applicable to a ship of the tonnage length of the ship undergoing measurement, ascertained by reference to columns A and B of Table I and corrected by the addition of a distance equal to the rise of the moulded frame line at one-quarter of the breadth of the ship between moulded frame lines at the said maximum height.

(3) The provisions of the paragraph shall also apply in the case of ships fitted with longitudinal floors and/or frames.

2. A double bottom situated in any part of a ship other than the main space for the propelling machinery, which is of greater height than a height consisting of a maximum height of double bottom applicable to a ship of the tonnage length of the ship undergoing measurement, ascertained by reference to columns A and C of Table I and corrected by the addition of a distance equal to the rise of the moulded frame line at one-quarter of the breadth of the ship between moulded frame lines at the said maximum height, shall be treated not as a double bottom but as an open floor of such height ascertained in accordance with the provisions of paragraph 1(2) as would be applicable in the case of a ship of the tonnage length of the ship undergoing measurement. Double bottoms.

3. (1) The horizontal width of bilge brackets measured from the shell of the ship to the inboard toe of the bracket shall not— Bilge brackets.

- (a) if taken at the level of the top of an open floor, exceed the maximum height of open floor applicable to the ship obtained by reference to columns A and B of Table I;
- (b) if taken at the level of the top of a double bottom, exceed the maximum height of double bottom applicable to the ship obtained by reference to Columns A and C of that Table.

**LAWS OF TRINIDAD AND TOBAGO**

MINISTRY OF THE ATTORNEY GENERAL AND LEGAL AFFAIRS

www.legalaffairs.gov.tt

356

**Chap. 50:10**

*Shipping*

[Subsidiary]

*Shipping (Tonnage) Regulations*

(2) In any case in which underdeck tonnage is measured by reference to a height ascertained and applied in accordance with the provisions of paragraphs 1 and 2, the lowest breadth used in the measurement of underdeck tonnage area shall be the breadth between the inner sides of the shell of the ship taken at that height, less twice the maximum height of open floor applicable to the ship obtained by reference to columns A and B of Table I or twice the width of the bilge bracket whichever is the less.

Allowance  
for ceiling.

4. The limitations imposed by the preceding three paragraphs are exclusive of an allowance for ceiling, if fitted.

Depth of  
frames.

5. (1) Subject to subparagraph (2), the extent to which the depth of transverse or longitudinal ship side framing in the case of any ship, measured from its shell, exceeds the maximum depth of frame applicable to a ship of the registered breadth of the ship undergoing measurement ascertained by reference to Table II shall be disregarded and the underdeck tonnage shall be measured accordingly by reference to the maximum depth of frame so ascertained.

(2) In the case of a ship in which alternate deep and shallow frames are fitted, the depth of frame used for purposes of measurement, measured from the shell of the ship, shall not exceed whichever is the lesser of the following dimensions:

- (a) twice the depth of the shallow frame; or
- (b) the maximum depth of frame applicable to the ship ascertained as aforesaid;

(3) The limitations imposed by subparagraphs (1) and (2) are exclusive of an allowance for sparring fitted on the toe of the frames.

---

UNOFFICIAL VERSION

UPDATED TO 31ST DECEMBER 2016

**TABLE I**

A Tonnage Length of Ship	B Maximum Height of Open Floors	C Maximum Height of Double Bottom
The dimensions shown are to be increased by 50 per cent for the foremost 25 per cent and aftermost 15 per cent of the tonnage length of the ship.		
<i>In feet</i>	<i>In inches</i>	<i>In inches</i>
Not exceeding 60	23	34.5
80	24	36
100	25	37.5
120	26	39
140	27	40.5
160	28	42
180	29	43.5
200	30	45
220	31	46.5
240	32	48
260	33	49.5
280	34	51
300	35	52.5
320	36	54
340	37	55.5
360	38	57
380	39	58.5
400	40	60
420	41	61.5
440	42	63
460	43	64.5
480	44	66
500	45	67.5
520	46	69
540	47	70.5
560	48	72
580	49	73.5
600	50	75
620	51	76.5
640	52	78
660	53	79.5
680	54	81
700	55	82.5

In the case of ships of intermediate length, the maximum height of floors or double bottoms shall be obtained by interpolation, and in the case of ships exceeding 700 feet by linear interpretation.

**LAWS OF TRINIDAD AND TOBAGO**

MINISTRY OF THE ATTORNEY GENERAL AND LEGAL AFFAIRS

www.legalaffairs.gov.tt

358

**Chap. 50:10**

*Shipping*

[Subsidiary]

*Shipping (Tonnage) Regulations*

**TABLE II**

Registered Breadth <i>In feet</i>	Maximum Depth of Frame <i>In inches</i>
Not exceeding 20	14
30	16
40	18
50	20
60	22
70	25
80	28
90	31
100 and above	34

In the case of ships of intermediate breadths, the maximum depth of frame shall be obtained by interpolation.

UNOFFICIAL VERSION

UPDATED TO 31ST DECEMBER 2016

APPENDIX C

TONNAGE MARK

1. Save as otherwise provided in paragraph 2, the tonnage mark shall consist as shown in Figure I of a horizontal line fifteen inches long and one inch wide upon which shall be placed for identification purposes an inverted equilateral triangle, each side of which is twelve inches long and one inch wide having its apex on the mid-point of the horizontal line.

Dimensions and shapes of tonnage mark.

2. In the case of a ship intended to operate in fresh or tropical waters as defined in the Load Line Regulations, not being a ship on which tonnage marks have been placed in accordance with paragraph 13 in Part E of this Schedule, an additional horizontal line may on the application of the owner of the ship be placed above the tonnage mark described in paragraph 1 at a distance of one forty-eighth (1/48th) of the moulded draught to that tonnage mark.

Additional horizontal line.

3. The additional line mentioned in paragraph 2 shall be nine inches long and one inch wide measured from a one inch wide vertical line (shown marked "W" in Figure 1) at the after end of, and perpendicular to, that tonnage mark and in such case, at all such times as the ship so marked is operating in fresh or tropical waters as aforesaid, this additional line shall be taken to be the tonnage mark in lieu of that described in paragraph 1.

Dimensions of additional horizontal line.

4. The lines and triangle above-mentioned shall be painted in white or yellow on a dark ground or in black on a light ground, and carefully cut in, centre punched or welded on the sides of the ship and shall be so kept and maintained as to be plainly visible at all times save when submerged.

Appearance of lines and triangle.

FIGURE 1

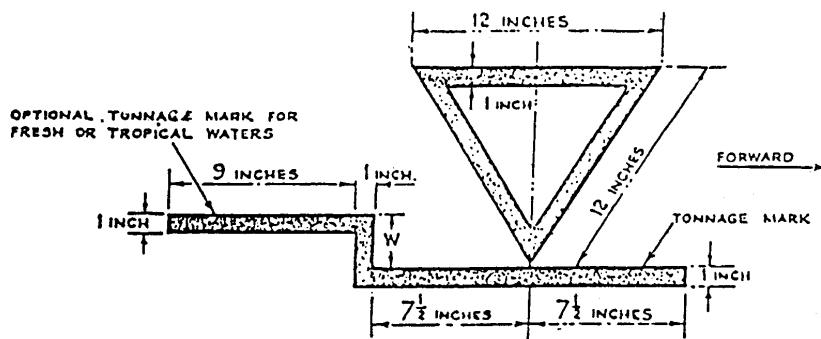

UNOFFICIAL VERSION

L.R.O.

## APPENDIX D

## POSITION OF TONNAGE MARKS

(Paragraphs 13 and 14 of the Fourth Schedule)

1. The tonnage mark shall be placed on each side of the ship at a distance below the line where the underside of the second deck stringer plate meets the ship's side plating amidships, or below the line equivalent to that line as shown in Figure 2 in cases where the deck is stepped, to be ascertained by reference to the Tonnage Mark Table at the end of this Appendix.

2. In the Tonnage Mark Table—

- (a) the length  $L_t$  in column A is the distance in feet on the second deck between the points at the forward and after ends of the deck where the underside of the deck or line of continuation thereof meets the inner surface of the frames, ceiling or sparring as the case may be in the middle plane of the ship, using an equivalent length in cases where the deck is stepped as shown in Figure 2;
- (b) the depth  $D_s$  is the depth in feet amidships from the top of the keel to the point at which the underside of the second deck stringer plate meets the ship's side plating, using an equivalent depth as Shown in Figure 2 in cases where the deck is stepped;
- (c) the figures at the top of columns B to J represent the ratio  $L_t/D_s$  and the figures below in each column represents distances in inches from the line where the underside of the second deck stringer plate meets the ship's side plating amidships (or, in cases where the deck is stepped, from the equivalent line thereto as shown in Figure 2) to the point at which the upper edge of the tonnage mark is to be placed.

3. In the case of any ship of intermediate length or having an intermediate  $L_t/D_s$  ratio, the relevant distance to be applied shall be obtained by interpolation, and in other cases where necessary by linear extrapolation.

4. The effective relevant distance calculated by reference to the Tonnage Mark Table to be applied in the case of any ship shall be corrected to the nearest half-inch.

FIGURE 2

**THIS SKETCH ILLUSTRATES HOW THE EQUIVALENT SECOND DECK SHOULD BE DETERMINED, BASED ON EQUAL LONGITUDINAL AREAS**

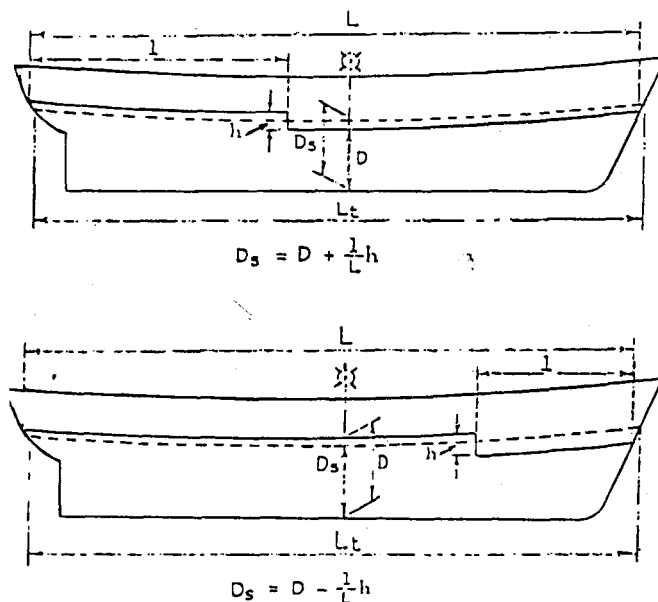

5. In the case of a ship to which load lines have been assigned the tonnage mark, subject to the provisions of paragraph 13 in Part E of this Schedule, shall be placed in a position ascertained in accordance with the foregoing provisions of this Appendix with the apex of the identification triangle of a distance of twenty-one inches horizontally aft of the centre line of the load line disc, save that in no case shall the tonnage marks be placed above the uppermost load line to which the ship may be loaded.

6. In the case of a ship to which load lines have not been assigned the tonnage marks shall be placed in a position ascertained in accordance with the foregoing provisions of this Appendix with the apex of the identification triangle at the middle of the length ( $L_t$ ) and in every such case the line of the upper deck shall be shown by a deck line corresponding in form to that required by the Load Line Regulations and placed centrally to a vertical line bisecting the identification triangle of the tonnage mark.

**LAWS OF TRINIDAD AND TOBAGO**

MINISTRY OF THE ATTORNEY GENERAL AND LEGAL AFFAIRS

www.legalaffairs.gov.tt

362

**Chap. 50:10**

*Shipping*

**[Subsidiary]**

*Shipping (Tonnage) Regulations*

Line Regulations and placed centrally to a vertical line bisecting the identification triangle of the tonnage mark.

**TONNAGE MARK TABLE**

A	B	C	D	E	F	G	H	I	J
Lt/Ds	12	13	14	15	16	17	18	19	20
Length <i>Lt. in feet</i>	<i>Distances in inches</i>								
220 and under	2.0	2.0	2.0	2.0	2.0	2.0	2.0	2.0	2.0
230	3.2	2.0	2.0	2.0	2.0	2.0	2.0	2.0	2.0
240	4.7	2.0	2.0	2.0	2.0	2.0	2.0	2.0	2.0
250	6.3	3.3	2.0	2.0	2.0	2.0	2.0	2.0	2.0
260	8.0	4.8	2.1	2.0	2.0	2.0	2.0	2.0	2.0
270	9.9	6.4	3.5	2.0	2.0	2.0	2.0	2.0	2.0
280	11.8	8.1	4.9	2.1	2.0	2.0	2.0	2.0	2.0
290	13.9	9.9	6.5	3.5	2.0	2.0	2.0	2.0	2.0
300	16.0	11.7	8.1	4.9	2.1	2.0	2.0	2.0	2.0
310	18.3	13.7	9.8	6.4	3.5	2.0	2.0	2.0	2.0
320	20.7	15.8	11.7	8.1	4.9	2.1	2.0	2.0	2.0
330	23.2	18.0	13.6	9.8	6.4	3.5	2.0	2.0	2.0
340	25.9	20.4	15.7	11.6	8.1	4.9	2.1	2.0	2.0
350	28.7	22.9	17.9	13.6	9.8	6.5	3.6	2.0	2.0
360	31.7	25.5	20.2	15.7	11.7	8.2	5.0	2.2	2.0
370	34.7	28.3	22.7	17.9	13.6	9.9	6.6	3.7	2.0

UNOFFICIAL VERSION

UPDATED TO 31ST DECEMBER 2016

*Shipping*

**Chap. 50:10**

*Shipping (Tonnage) Regulations*

[Subsidiary]

A	B	C	D	E	F	G	H	I	J
Lt/Ds	12	13	14	15	16	17	18	19	20
Length <i>Lt. in feet</i>	<i>Distances in inches</i>								
380	38.0	31.1	25.3	20.2	15.7	11.8	8.3	5.2	2.4
390	41.3	34.1	27.9	22.6	17.9	13.8	10.1	6.8	3.8
400	44.8	37.2	30.7	25.0	20.1	15.8	11.9	8.4	5.3
410	48.2	40.3	33.5	27.7	22.6	18.1	14.0	10.4	7.2
420	51.5	43.4	36.4	30.4	25.2	20.6	16.4	12.7	9.4
430	54.8	46.5	39.4	33.3	27.9	23.2	19.0	15.2	11.8
440	58.4	49.9	42.6	36.4	30.9	26.0	21.7	17.8	14.4
450	62.1	53.4	46.0	39.6	33.9	29.0	24.6	20.6	17.1
460	65.9	57.0	49.5	42.9	37.1	32.1	27.6	23.5	19.9
470	69.8	60.7	53.0	46.3	40.4	35.2	30.6	26.5	22.8
480	73.7	64.4	56.5	49.7	43.7	38.4	33.7	29.5	25.7
490	77.5	68.1	60.0	53.0	46.9	41.5	36.7	32.4	28.5
500	81.2	71.6	63.4	56.2	50.0	44.5	39.6	35.2	31.2
510	84.9	75.1	66.7	59.4	53.0	47.4	42.4	37.9	33.9
520	88.4	78.4	69.9	62.4	55.9	50.2	45.1	40.5	36.4
530	91.8	81.6	72.9	65.3	58.7	52.9	47.7	43.0	38.8
540	95.2	84.8	75.9	68.1	61.4	55.5	50.2	45.4	41.2
550	98.4	87.8	78.8	70.9	64.0	58.0	52.6	47.8	43.4
560	101.6	90.8	81.6	73.6	66.6	60.5	55.0	50.1	45.6

**LAWS OF TRINIDAD AND TOBAGO**

MINISTRY OF THE ATTORNEY GENERAL AND LEGAL AFFAIRS

www.legalaffairs.gov.tt

364

**Chap. 50:10**

*Shipping*

**[Subsidiary]**

*Shipping (Tonnage) Regulations*

**TONNAGE MARK TABLE—Continued**

A	B	C	D	E	F	G	H	I	J
Lt/Ds	12	13	14	15	16	17	18	19	20
Length <i>Lt. in feet</i>	<i>Distances in inches</i>								
570	104.8	93.8	84.4	76.3	69.2	62.9	57.3	52.3	47.8
580	107.9	96.8	87.2	78.9	71.7	65.3	59.6	54.5	49.9
590	111.0	99.7	90.0	81.5	74.2	67.7	61.9	56.7	52.0
600	114.0	102.5	92.6	84.0	76.5	69.9	64.0	58.8	54.0
610	117.0	105.3	95.2	86.5	78.9	72.1	66.2	60.8	56.0
620	120.0	108.0	97.8	88.9	81.2	74.4	68.3	62.8	58.0
630	122.9	110.7	100.4	91.3	83.5	76.6	70.4	64.8	59.9
640	125.7	113.4	102.9	93.7	85.8	78.7	72.4	66.8	61.7
650	128.6	116.1	105.4	96.1	88.0	80.8	74.4	68.7	63.6
660	131.4	118.7	107.8	98.3	90.1	82.8	76.3	70.6	65.3
670	134.2	121.2	110.2	100.6	92.2	84.8	78.3	72.4	67.1
680	136.9	123.8	112.6	102.9	94.3	86.8	80.2	74.2	68.9
690	139.6	126.3	115.0	105.1	96.4	88.8	82.1	76.0	70.6
700	142.3	128.8	117.3	107.3	98.5	90.8	83.9	77.8	72.3
710	144.9	131.3	119.6	109.4	100.5	92.7	85.7	79.5	73.9
720	147.5	133.7	121.8	111.5	102.5	94.6	87.5	81.2	75.5
730	150.1	136.1	124.0	113.6	104.5	96.5	89.3	82.9	77.1
740	152.7	138.5	126.2	115.7	106.5	98.3	91.1	84.5	78.7

UNOFFICIAL VERSION

UPDATED TO 31ST DECEMBER 2016

*Shipping*

**Chap. 50:10**

365

*Shipping (Tonnage) Regulations*

**[Subsidiary]**

A	B	C	D	E	F	G	H	I	J
Lt/Ds	12	13	14	15	16	17	18	19	20
Length <i>Lt. in feet</i>	<i>Distances in inches</i>								
750	155.3	140.8	128.5	117.8	108.4	100.1	92.8	86.1	80.3
760	157.8	143.1	130.6	119.7	110.3	101.9	94.4	87.8	81.7
770	160.2	145.4	132.7	121.7	112.1	103.6	96.0	89.3	83.2
780	162.6	147.6	134.8	123.7	113.9	105.3	97.6	90.8	84.7
790	165.1	149.9	136.9	125.6	115.7	107.0	99.2	92.3	86.1
800	167.5	152.1	138.9	127.4	117.4	108.6	100.8	93.8	87.4

LAWS OF TRINIDAD AND TOBAGO

MINISTRY OF THE ATTORNEY GENERAL AND LEGAL AFFAIRS

www.legalaffairs.gov.tt

366

Chap. 50:10

Shipping

[Subsidiary]

Shipping (Tonnage) Regulations

APPENDIX E

PLEASURE CRAFT UNDER FORTY-FIVE FEET IN LENGTH—ASCERTAINMENT OF TONNAGE

Tonnage to be in terms of cubic capacity. Elements of tonnage.

1. Tonnage in relation to any pleasure craft to which Part F of this Schedule applies shall be measured in terms of cubic capacity.

2. The tonnage of the craft shall be the sum of—

- (a) the product of multiplying together its overall length, breadth and depth, and multiplying the resultant figure by 0.0045; and
- (b) the tonnage of any break or breaks defined in paragraph 5 herein and calculated in accordance with the provisions of that paragraph.

Breadth of craft.

3. The breadth of a craft for this purpose shall be its extreme breadth over the outside plating, planking or hull, no account being taken of rubbers or fenders even if they are moulded so as to be integral with the hull.

Depth of craft.

4. (1) The depth of a craft for this purpose shall be measured vertically midway between the foremost and after most points of measurement of its length.

(2) The upper terminal point for depth measured under subparagraph (1) shall be—

- (a) in the case of a decked craft, the underside of the deck on the middle line or, if there is no deck at the middle line at the point of measurement, the underside of the deck at side of the craft plus the full deck camber;
- (b) in the case of an open craft, the top of the upper strake or gunwale.

(3) The lower terminal point for depth measured under subparagraph (1) shall be—

- (a) in the case of a wooden craft, the upper side of planking at side of keel or hog;
- (b) in the case of a metal craft, the top of plating at side of keel;
- (c) in the case of a glass reinforce plastic craft, the inside of the hull; where no keel member is fitted and the keel is of open trough construction, the lower terminal point for depth shall be the top of the keel filling, if fitted, or the level at which the inside breadth of the trough is four inches, whichever gives the lesser depth.

(4) Where a break exists in way of the point of measurement for depth under subparagraph (1) the height of the break shall not be included in the measurement of depth.

Measurement of breaks.

5. A break for the purpose of paragraph 2(b) shall be a side to side break existing in the line of the deck, and its tonnage shall be the figure obtained by multiplying together the mean length, mean breadth and mean height of the break and dividing the product by one hundred.

Units of measurement.

6. All measurements shall be taken and expressed in feet and decimals of one foot to the nearest one-tenth of one foot.

Accuracy of tonnage figures.

7. Tonnage shall be expressed to two decimal places, the second decimal place being increased by one if the third decimal place is five or more.

UNOFFICIAL VERSION

UPDATED TO 31ST DECEMBER 2016

---

**SHIPPING (NAVIGATIONAL AIDS DUES) (NO. 2)  
REGULATIONS**

ARRANGEMENT OF REGULATIONS

**REGULATION**

1. Citation.
2. Interpretation.
3. Navigational aids dues.
4. Exemptions.
5. Revocation.
6. Commencement.

**SCHEDULE.**

---

[Subsidiary]

221/1989.  
[64/1995  
57/1996].

**SHIPPING (NAVIGATIONAL AIDS DUES) (NO. 2)  
REGULATIONS**

*made under section 225(1)*

- Citation.                   **1.** These Regulations may be cited as the Shipping (Navigational Aids Dues) (No. 2) Regulations.
- Interpretation.           **2.** In these Regulations “the Act” means the Shipping Act.
- Navigational aids dues.   **3.** Navigational aids dues shall be levied in accordance with—  
                                  (a) the scale of payments set out in Part II of the Schedule; and  
                                  (b) the rules set out in Part III of the Schedule.
- Schedule.
- Exemptions.               **4.** Navigational dues shall not be levied in the cases listed in Part IV of the Schedule.
- Revocation.               **5.** The Shipping (Navigational Aids Dues) Regulations, are hereby revoked.
- Commencement.           **6.** These Regulations have effect from 1st January, 1990.
-

**SCHEDULE**

**PART I**

**DEFINITIONS**

In this Schedule—

- (a) a ship's tonnage shall be its net tonnage entered in its certificate of registry or certificate of tonnage issued by or on behalf of the administration of the State of Registry; except that where the tonnage is less than one thousand tons it shall be deemed to be one thousand tons, and where it is more than twenty thousand tons it shall be deemed to be twenty thousand tons;
- (b) "Caricom Ship" means a ship that is registered in a Caricom Member State;
- (c) "cruise ship" means a ship that makes a call at a port in Trinidad and Tobago for the purpose of embarking or disembarking passengers and while in Trinidad and Tobago waters, the ship does not load or discharge any cargo or mails, at any such port;
- (d) "foreign fishing vessel" means a fishing vessel registered as a fishing vessel under the law of a foreign country;
- (e) "foreign ship" means a ship that is not a Caricom ship;
- (f) "length" in relation to a fishing vessel means the registered length shown in the vessel's certificate of registry and in relation to a fishing vessel having no registered length, means the length which would be the registered length if the vessel was registered under the Act. In calculating the payment of navigational aids dues where a fishing vessel's length is not a multiple of one metre, any excess not exceeding half a metre shall be rounded down and any excess over a half a metre shall be rounded up to the nearest of such multiple;
- (g) a year shall be reckoned from 1st January.

LAWS OF TRINIDAD AND TOBAGO

MINISTRY OF THE ATTORNEY GENERAL AND LEGAL AFFAIRS

www.legalaffairs.gov.tt

370

Chap. 50:10

Shipping

[Subsidiary]

Shipping (Navigational Aids Dues) (No. 2) Regulations

Regulation 3(a).

PART II

SCALE OF PAYMENTS OF NAVIGATIONAL AIDS DUES

1. Caricom ships—

Full rate	...	...	...	\$0.15 per ton per voyage
Reduced rate	...	...	...	\$0.05 per ton per voyage

2. Foreign ships—

Full rate	...	...	...	\$0.30 per ton per voyage
Reduced rate	...	...	...	\$0.10 per ton per voyage

3. Navigational aids dues shall be levied on cruise ships in accordance with the reduced rate as specified in paragraphs 1 and 2.

4. Instead of payments per voyage the following payments of Navigational aids dues shall be applicable:

- (a) for pleasure craft, which the Director of Maritime Services is satisfied are ordinarily kept or used outside the waters of Trinidad and Tobago, a payment of fifty dollars per visit for every period of thirty days or less comprised in such visit with an additional payment of fifty dollars for every period of thirty days or less exceeding the initial period of thirty days in any one year;
- (b) for ships, with the exception of pleasure craft and fishing vessels, licensed under the Act or the Motor Launches Act, an annual payment of two hundred dollars;
- (c) for ships, other than fishing vessels, registered under the Act and trading solely within the waters of Trinidad and Tobago, an annual payment of one dollar per ton;
- (d) for foreign registered ships trading solely within the waters of Trinidad and Tobago an annual payment of two dollars per ton;
- (e) for foreign fishing vessels of ten metres or more in length, an annual payment of one thousand dollars per vessel plus a payment of fifteen dollars for each metre of length in excess of ten metres; or
- (f) for foreign fishing vessels, a payment of two hundred dollars per visit for up to ten visits in any year.

Ch. 50:08.

UNOFFICIAL VERSION

UPDATED TO 31ST DECEMBER 2016

**PART III**

Regulation 3(b).

**RULES**

1. In any year, navigational aids dues shall not be levied on a ship—
  - (a) for more than twenty voyages, in the case of a Caricom ship;
  - (b) for more than ten voyages, in the case of a foreign ship.
2. The annual payments in accordance with the scale shall be payable at the commencement of the year in respect of which they are due except that a vessel which is put into service after 30th June of any year shall only be required to pay fifty per cent of the annual payment for that particular year.
3. Every payment referred to in paragraph 4(a) of Part II shall be paid at the commencement of the period in respect of which it is due save that a vessel shall not be required to make payments in excess of five hundred dollars in any one year.
4. Dues payable in accordance with these Regulations shall be paid at the office of the Division of the Maritime Services, or at such other place as may be approved by the Director of Maritime Services.
5. Where navigational aids dues are not paid, the outstanding amount remains a charge against the ship and the ship may be detained until full payment is made by the owner or master of the ship.

**PART IV**

Regulation 4.

**EXEMPTIONS**

There shall be exempt from navigational aids dues—

- (a) ships including naval and research vessels, belonging to the Government of Trinidad and Tobago or to a foreign Government unless they are carrying cargo or passengers for freight or fares respectively, or are engaged in any other type of commercial activity;
- (b) ships putting in for bunkers, stores or provisions for their own use on board;
- (c) ships putting in as a result of stress of weather or damage or for the purpose of repairs, if they do not discharge or load cargo other than cargo which is discharged with a view to such repairs and is to be re-shipped afterwards;

**LAWS OF TRINIDAD AND TOBAGO**

MINISTRY OF THE ATTORNEY GENERAL AND LEGAL AFFAIRS

www.legalaffairs.gov.tt

372

**Chap. 50:10**

*Shipping*

[Subsidiary]

*Shipping (Navigational Aids Dues) (No. 2) Regulations*

**PART IV—Continued**

**EXEMPTIONS—Continued**

- (d) dredgers and hoppers for the time being employed solely in dredging channels or deepening water for or on behalf of a harbour authority or a conservancy authority, within the area in which that authority has jurisdiction, or in disposing, within or without such area otherwise than by way of sale or exchange, of the spoil from such operations;
- (e) sailing yachts or other craft which are not registered or licensed in Trinidad and Tobago, and which, as determined to the satisfaction of the Director of Maritime Services, come into the waters of Trinidad and Tobago with the sole object of taking part in racing regattas, so long as such vessels are coming into, remaining in, or leaving such waters solely in connection with that object;
- (f) Trinidad and Tobago licensed ships in respect of any year ending 31st December during the whole period of which they are laid up;
- (g) tugs and other utility craft owned by a harbour or port authority when employed by that authority within the area in which that authority has jurisdiction;
- (h) such other ships as the Minister may specifically or generally exempt in writing.

---

UNOFFICIAL VERSION

UPDATED TO 31ST DECEMBER 2016

**SHIPPING (SEAMEN'S DISCHARGE BOOK FEES) REGULATIONS** 225/1990.

*made under section 406*

1. These Regulations may be cited as the Shipping Citation.  
(Seamen's Discharge Book Fees) Regulations.

2. There shall be paid by seamen, fees for the issue or Discharge book  
renewal of seamen's discharge books as follows: fees.

- (a) for the issue or renewal of a discharge book—  
\$30.00;
- (b) for the reissue of a discharge book that was lost  
or destroyed because of shipwreck, fire or other  
cases of *force majeure*—\$15.00.

---

**SHIPPING (DISTRESS SIGNALS AND PREVENTION  
OF COLLISIONS) REGULATIONS**

ARRANGEMENT OF REGULATIONS

**REGULATION**

1. Citation.
2. Interpretation.
3. Application.
4. Signals of distress.
5. Compliance with International Regulations.
6. Penalties.
7. Power to detain.

**SCHEDULE.**

**SHIPPING (DISTRESS SIGNALS AND PREVENTION OF COLLISIONS) REGULATIONS** 242/1990.

*made under sections 204 and 214*

**1.** These Regulations may be cited as the Shipping (Distress Signals and Prevention of Collisions) Regulations. Citation.

**2.** In these Regulations— Interpretation.  
“the Act” means the Shipping Act;  
“the International Regulations” means the International Regulations for the Prevention of Collisions at Sea 1972 as amended by Resolution A464 (XII) and Resolution A626 (15) of the International Maritime Organisation and set out in the Schedule; Schedule.  
“Trinidad and Tobago ship” has the same meaning as in section 2 of the Act.

**3.** (1) These Regulations apply to Trinidad and Tobago ships wherever they may be and to other vessels while they are within the waters of Trinidad and Tobago. Application.

(2) In this Regulation “vessels” includes hovercraft and seaplanes whilst they are manoeuvring on the water.

**4.** (1) The signals of distress which shall be used by vessels to which these Regulations apply are those set out in Annex IV to the International Regulations. Signals of distress.

(2) No signals of distress shall be used by any vessel unless the master of the vessel so orders.

(3) The master of a vessel shall not order, any signal of distress to be used by his vessel unless he is satisfied—

(a) that his vessel is in serious and imminent danger, or that another ship or an aircraft is in serious and imminent danger and cannot of itself send that signal; and

(b) that the vessel in danger, whether his own vessel or another vessel, or the aircraft in danger, as the case may be, requires immediate assistance in addition to any assistance then available to her.

LAWS OF TRINIDAD AND TOBAGO

MINISTRY OF THE ATTORNEY GENERAL AND LEGAL AFFAIRS

www.legalaffairs.gov.tt

376

Chap. 50:10

Shipping

[Subsidiary]

Shipping (Distress Signals and Prevention of Collisions) Regulations

(4) The master of a vessel which has sent any signal of distress by means of radio or otherwise, shall cause that signal to be revoked, by all appropriate means as soon as he is satisfied that the vessel or aircraft to which the signal relates is no longer in need of assistance.

Compliance  
with  
International  
Regulations.

5. Vessels to which these Regulations apply shall comply with the provisions of the International Regulations, save that nothing in these Regulations shall be taken to require a vessel or class of vessel to comply with any of the stipulations of paragraphs (a) to (h) of Rule 38 of the International Regulations where by virtue of Rule 38 that vessel may be exempted from such compliance.

Penalties.

6. (1) Where any of these Regulations is contravened, the owner of the vessel, the master and any person for the time being responsible for the conduct of the vessel are each guilty of an offence and liable to a fine of five thousand dollars and imprisonment for six months.

(2) Where a master of a ship uses or displays or causes or permits any person under his authority to use or display—

- (a) any signal except in the circumstances and for the purposes prescribed; and
- (b) any signal that is liable to be mistaken for any prescribed signal, he is guilty of an offence and, in addition to any penalty imposed upon him on conviction, is liable to pay compensation for any work undertaken, risk incurred or loss sustained in consequence of the signal having been supposed to be a signal of distress or urgency and such compensation may, without prejudice to any other remedy, be recovered in the same manner in which salvage is recoverable.

(3) Where the master who contravenes subregulation (2) is an officer certificated or licensed under the Act, he shall be subject to an enquiry into his conduct as provided in section 375 of the Act.

UNOFFICIAL VERSION

UPDATED TO 31ST DECEMBER 2016

(4) It shall be a defence for any person charged under these Regulations to show that he took all reasonable precautions to avoid the commission of the offence.

7. In any case where a ship does not comply with the requirements of these Regulations, the ship is liable to be detained and section 387 of the Act shall have effect in relation to the ship, subject to the modification that for the words, “this Act” wherever they appear, there shall be substituted the words, “the Shipping (Distress Signals and Prevention of Collisions) Regulations”. Power to detain.

---

## SCHEDULE

1. (1) In this Schedule—

“appropriate authority” means in relation to Trinidad and Tobago, the Minister, and in relation to any other State the authority responsible under the law of that State for promoting the safety of life at sea and the avoidance of collisions;

“Minister” has the same meaning as in section 2 of the Act;

“the diagram” referred to in paragraph 7 of Annex I to the International Regulations means the diagram specified in the Chromaticity Chart (1975) published by the International Commission on Illumination (CIE);

“the International Code of Signals” mentioned in paragraph 3 of Annex IV to the International Regulations means the International Code of Signals (1987) published by the International Maritime Organisation, or any document amending or replacing that publication which is considered by the Minister to be relevant;

“the Merchant Ship Search and Rescue Manual” mentioned in paragraph 3 of Annex IV to the International Regulations means the manual of that name published in 1986 by the International Maritime Organisation or any document amending or replacing that publication which is considered by the Minister to be relevant;

“the traffic separation schemes” referred to in Rule 10(a) of the International Regulations means the schemes listed in the Organisation’s publication entitled “Ships Routing” or any document amending or replacing it which is considered by the Minister to be relevant.

(2) The “date of entry into force” of the International Regulations for the purposes of Rule 38 of those Regulations means—

- (a) in the case of Trinidad and Tobago ships, the 15th February, 1979; and
- (b) in the case of a vessel registered outside of Trinidad and Tobago, the date of entry into force of the International Regulations for the State whose flag the vessel is entitled to fly.

## INTERNATIONAL REGULATIONS FOR PREVENTING COLLISIONS AT SEA, 1972

*[as amended by Resolution A464(xII) and Resolution A626(15)]*

### PART A—GENERAL

#### RULE 1

##### *Application*

(a) These Rules shall apply to all vessels upon the high seas and in all waters connected therewith navigable by seagoing vessels.

(b) Nothing in these Rules shall interfere with the operation of special rules made by an appropriate authority for roadsteads, harbours, rivers, lakes or inland waterways connected with the high seas and navigable by seagoing vessels. Such special rules shall conform as closely as possible to these Rules.

(c) Nothing in these Rules shall interfere with the operation of any special rules made by the Government of any State with respect to additional station or signal lights, shapes or whistle signals for ships of war and vessels proceeding under convoy, or with respect to additional station or signal lights or shapes for fishing vessels engaged in fishing as a fleet. These additional station or signal lights, shapes or whistle signals shall, so far as possible, be such that they cannot be mistaken for any light, shape or signal authorised elsewhere under these Rules.

(d) Traffic separation schemes may be adopted by the Organisation for the purpose of these Rules.

(e) Whenever the Government concerned shall have determined that a vessel of special construction or purpose cannot comply fully with the provisions of any of these Rules with respect to the number, position, range or arc of visibility of lights or shapes, as well as to the disposition and characteristics of sound-signalling appliances, such vessel shall comply with

such other provisions in regard to the number, position, range or are of visibility of lights or shapes, as well as to the disposition and characteristics of sound signalling appliances, as her Government shall have determined to be the closest possible compliance with these Rules in respect of that vessel.

**RULE 2**

*Responsibility*

(a) Nothing in these Rules shall exonerate any vessel, or the owner, master or crew thereof, from the consequences of any neglect to comply with these Rules or of the neglect of any precaution which may be required by the ordinary practice of seamen, or by the special circumstances of the case.

(b) In construing and complying with these Rules due regard shall be had to all dangers of navigation and collision and to any special circumstances, including the limitations of the vessels involved, which may make a departure from these Rules necessary to avoid immediate danger.

**RULE 3**

*General definitions*

For the purpose of these Rules, except where the context otherwise requires—

- (a) The word “vessel” includes every description of water craft, including non-displacement craft and seaplanes, used or capable of being used as a means of transportation on water.
- (b) The term “power-driven vessel” means any vessel propelled by machinery.
- (c) The term “sailing vessel” means any vessel under sail provided that propelling machinery, if fitted, is not being used.
- (d) The term “vessel engaged in fishing” means any vessel fishing with nets, lines, trawls or other fishing apparatus which restrict manoeuvrability, but does not include a vessel fishing with trolling lines or other fishing apparatus which do not restrict manoeuvrability.
- (e) The word “seaplane” includes any aircraft designed to manoeuvre on the water.
- (f) The term “vessel not under command” means a vessel which through some exceptional circumstance is unable to manoeuvre as required by these Rules and is therefore unable to keep out of the way of another vessel.

- (g) The term “vessel restricted in her ability to manoeuvre” means a vessel which from the nature of her work is restricted in her ability to manoeuvre as required by these Rules and is therefor unable to keep out of the way of another vessel. The term “vessels restricted in their ability to manoeuvre” shall include but not be limited to:
- (i) a vessel engaged in laying, servicing or picking up a navigation mark, submarine cable or pipeline;
  - (ii) a vessel engaged in dredging, surveying or underwater operations;
  - (iii) a vessel engaged in replenishment or transferring persons, provisions or cargo while underway;
  - (iv) a vessel engaged in the launching or recovery of aircraft;
  - (v) a vessel engaged in mine-clearance operations;
  - (vi) a vessel engaged in a towing operation such as severely restricts the towing vessel and her tow in their ability to deviate from their course.
- (h) The term “vessel constrained by her draught” means a power-driven vessel which, because of her draught in relation to the available depth and width of navigable water, is severely restricted in her ability to deviate from the course she is following.
- (i) The word “underway” means that a vessel is not at anchor, or made fast to the shore, or aground.
- (j) The words “length” and “breadth” of a vessel mean her length overall and greatest breadth.
- (k) Vessels shall be deemed to be in sight of one another only when one can be observed visually from the other.
- (l) The term “restricted visibility” means any condition in which visibility is restricted by fog, mist, falling snow, heavy rainstorms, sandstorms or any other similar causes.

## PART B—STEERING AND SAILING RULES

### Section 1. Conduct of vessels in any condition of visibility

#### RULE 4

##### *Application*

Rules in this Section apply in any condition of visibility.

**RULE 5**

*Look-out*

Every vessel shall at all times maintain a proper look-out by sight and hearing as well as by all available means appropriate in the prevailing circumstances and conditions so as to make a full appraisal of the situation and of the risk of collision.

**RULE 6**

*Safe Speed*

Every vessel shall at all times proceed at a safe speed so that she can take proper and effective action to avoid collision and be stopped within a distance appropriate to the prevailing circumstances and conditions.

In determining a safe speed the following factors shall be among those taken into account:

- (a) By all vessels—
  - (i) the state of visibility;
  - (ii) the traffic density including concentrations of fishing vessels or any other vessels;
  - (iii) the manoeuvrability of the vessel with special reference to stopping distance and turning ability in the prevailing conditions;
  - (iv) at night the presence of background light such as from shore lights or from back scatter of her own lights;
  - (v) the state of wind, sea and current, and the proximity of navigational hazards;
  - (vi) the draught in relation to the available depth of water.
- (b) Additionally, by vessels with operational radar—
  - (i) the characteristics, efficiency and limitations of the radar equipment;
  - (ii) any constraints imposed by the radar range scale in use;
  - (iii) the effect on radar detection of the sea state, weather and other sources of interference;
  - (iv) the possibility that small vessels, ice and other floating objects may not be detected by radar at an adequate range;
  - (v) the number, location and movement of vessels detected by radar;
  - (vi) the more exact assessment of the visibility that may be possible when radar is used to determine the range of vessels or other objects in the vicinity.

## RULE 7

*Risk of collision*

(a) Every vessel shall use all available means appropriate to the prevailing circumstances and conditions to determine if risk of collision exists. If there is any doubt such risk shall be deemed to exist.

(b) Proper use shall be made of radar equipment if fitted and operational, including long range scanning to obtain early warning of risk of collision and radar plotting or equivalent systematic observation of detected objects.

(c) Assumptions shall not be made on the basis of scanty information, especially scanty radar information.

(d) In determining if risk of collision exists the following considerations shall be among those taken into account:

- (i) such risk shall be deemed to exist if the compass bearing of an approaching vessel does not appreciably change;
- (ii) such risk may sometimes exist even when an appreciable bearing change is evident, particularly when approaching a very large vessel or a tow or when approaching a vessel at close range.

## RULE 8

*Action to avoid collision*

(a) Any action taken to avoid collision shall, if the circumstances of the case admit, be positive, made in ample time and with due regard to the observance of good seamanship.

(b) Any alteration of course and/or speed to avoid collision shall, if the circumstances of the case admit, be large enough to be readily apparent to another vessel observing visually or by radar; a succession of small alterations of course and/or speed should be avoided.

(c) If there is sufficient sea room, alteration of course alone may be the most effective action to avoid a close-quarters situation provided that it is made in good time, is substantial and does not result in another close-quarters situation.

(d) Action taken to avoid collision with another vessel shall be such as to result in passing at a safe distance. The effectiveness of the action shall be carefully checked until the other vessel is finally past and clear.

(e) If necessary to avoid collision or allow more time to assess the situation, a vessel shall slacken her speed or take all way off by stopping or reversing her means of propulsion.

(f) (i) A vessel which, by any of these Rules, is required not to impede the passage or safe passage of another vessel shall, when required by the circumstances of the case, take early action to allow sufficient sea room for the safe passage of the other vessel.

(ii) A vessel required not to impede the passage or safe passage of another vessel is not relieved of this obligation if approaching the other vessel so as to involve risk of collision and shall, when taking action have full regard to the action, which may be required by the Rules of this Part.

(iii) A vessel the passage of which is not to be impeded remains fully obliged to comply with the Rules of this Part when the two vessels are approaching one another so as to involve risk of collision.

#### **RULE 9**

##### *Narrow channels*

(a) A vessel proceeding along the course of a narrow channel or fairway shall keep as near to the outer limit of the channel or fairway which lies on her starboard side as is safe and practicable.

(b) A vessel of less than 20 metres in length or a sailing vessel shall not impede the passage of a vessel which can safely navigate only within a narrow channel or fairway.

(c) A vessel engaged in fishing shall not impede the passage of any other vessel navigating within a narrow channel or fairway.

(d) A vessel shall not cross a narrow channel or fairway if such crossing impedes the passage of a vessel which can safely navigate only within such channel or fairway. The latter vessel may use the sound signal prescribed in Rule 34(d) if in doubt as to the intention of the crossing vessel.

(e) (i) In a narrow channel or fairway when overtaking can take place only if the vessel to be overtaken has to take action to permit safe passing, the vessel intending to overtake shall indicate her intention by sounding the appropriate signal prescribed in Rule 34(c)(i). The vessel to be overtaken shall, if in agreement, sound the appropriate signal prescribed in Rule 34(c)(ii) and take steps to permit safe passing. If in doubt she may sound the signals prescribed in Rule 34(d).

(ii) This Rule does not relieve the overtaking vessel of her obligation under Rule 13.

(f) A vessel nearing a bend or an area of a narrow channel or fairway where other vessels may be obscured by an intervening obstruction shall navigate with particular alertness and caution and shall sound the appropriate signal prescribed in Rule 34(e).

(g) Any vessel shall, if the circumstances of the case admit, avoid anchoring in a narrow channel.

#### RULE 10

##### *Traffic separation schemes*

(a) This Rule applies to traffic separation schemes adopted by the Organisation and does not relieve any vessel of her obligation under any other Rule.

(b) A vessel using a traffic separation scheme shall—

- (i) proceed in the appropriate traffic lane in the general direction of traffic flow for that lane;
- (ii) so far as practicable keep clear of a traffic separation lane or separation zone;
- (iii) normally join or leave a traffic lane at the termination of the lane, but when joining or leaving from either side shall do so at as small an angle to the general direction of traffic flow as practicable.

(c) A vessel shall so far as practicable avoid crossing traffic lanes, but if obliged to do so shall cross on a heading as nearly as practicable at right angles to the general direction of traffic flow.

(d) Inshore traffic zones shall not normally be used by through traffic which can safely use the appropriate traffic lane within the adjacent traffic separation scheme. However, vessels of less than 20 metres in length and sailing vessels may under all circumstances use inshore traffic zones.

(e) A vessel other than a crossing vessel or a vessel joining or leaving a lane shall not normally enter a separation zone or cross a separation line except:

- (i) in cases of emergency to avoid immediate danger;
- (ii) to engage in fishing within a separation zone.

(f) A vessel navigating in areas near the terminations of traffic separation schemes shall do so with particular caution.

(g) A vessel shall so far as practicable avoid anchoring in a traffic separation scheme or in areas near its terminations.

(h) A vessel not using a traffic separation scheme shall avoid it by as wide a margin as is practicable.

(i) A vessel engaged in fishing shall not impede the passage of any vessel following a traffic lane.

(j) A vessel of less than 20 metres in length or a sailing vessel shall not impede the safe passage of a power-driven vessel following a traffic lane.

(k) A vessel restricted in her ability to manoeuvre when engaged in an operation for the maintenance of safety of navigation in a traffic separation scheme is exempted from complying with this Rule to the extent necessary to carry out the operation.

(l) A vessel restricted in her ability to manoeuvre when engaged in an operation for the laying, servicing or picking up of a submarine cable, within a traffic separation scheme, is exempted from complying with this Rule to the extent necessary to carry out the operation.

## **Section II. Conduct of vessels in sight of one another**

### **RULE 11**

#### *Application*

Rules in this Section apply to vessels in sight of one another.

### **RULE 12**

#### *Sailing vessels*

(a) When two sailing ships are approaching one another, so as to involve risk of collision, one of them shall keep out of the way of the other as follows:

- (i) when each has the wind on a different side, the vessel which has the wind on the port side shall keep out of the way of the other;
- (ii) when both have the wind on the same side, the vessel which is to windward shall keep out of the way of the vessel which is to leeward;
- (iii) if a vessel with the wind on the port side sees a vessel to windward and cannot determine with certainty whether the other vessel has the wind on the port or on the starboard side, she shall keep out of the way of the other.

(b) For the purposes of this Rule the windward side shall be deemed to be the side opposite to that on which the mainsail is carried or, in the case of a square-rigged vessel, the side opposite to that on which the largest fore-and-aft sail is carried.

## RULE 13

*Overtaking*

(a) Notwithstanding anything contained in the Rules of Part B, Sections I and II any vessel overtaking any other shall keep out of the way of the vessel being overtaken.

(b) A vessel shall be deemed to be overtaking when coming up with another vessel from a direction more than 22.5 degrees abaft her beam, that is, in such a position with reference to the vessel she is overtaking, that at night she would be able to see only the sternlight of that vessel but neither of her sidelights.

(c) When a vessel is in any doubt as to whether she is overtaking another, she shall assume that this is the case and act accordingly.

(d) Any subsequent alteration of the bearing between the two vessels shall not make the overtaking vessel a crossing vessel within the meaning of these Rules or relieve her of the duty of keeping clear of the overtaken vessel until she is finally past and clear.

## RULE 14

*Head-on situation*

(a) When two power-driven vessels are meeting on reciprocal or nearly reciprocal courses so as to involve risk of collision each shall alter her course to starboard so that each shall pass on the port side of the other.

(b) Such a situation shall be deemed to exist when a vessel sees the other ahead or nearly ahead and by night she could see the mast head lights of the other in a line or nearly in a line and/or both sidelights and by day she observes the corresponding aspect of the other vessel.

(c) When a vessel is in any doubt as to whether such a situation exists she shall assume that it does exist and act accordingly.

## RULE 15

*Crossing situation*

When two power-driven vessels are crossing so as to involve risk of collision, the vessel which has the other on her own starboard side shall keep out of the way and shall, if the circumstances of the case admit, avoid crossing ahead of the other vessel.

**RULE 16**

*Action by give-way vessel*

Every vessel which is directed to keep out of the way of another vessel shall, so far as possible, take early and substantial action to keep well clear.

**RULE 17**

*Action by stand-on vessel*

(a) (i) Where one of two vessels is to keep out of the way the other shall keep her course and speed.

(ii) The latter vessel may however take action to avoid collision by her manoeuvre alone, as soon as it becomes apparent to her that the vessel required to keep out of the way is not taking appropriate action in compliance with these Rules.

(b) When, from any cause, the vessel required to keep her course and speed finds herself so close that collision cannot be avoided by the action of the give-way vessel alone, she shall take such action as will best aid to avoid collision.

(c) A power-driven vessel which takes action in a crossing situation in accordance with subparagraph (a)(ii) of this Rule to avoid collision with another power-driven vessel shall, if the circumstances of the case admit, not alter course to port for a vessel on her own port side.

(d) This Rule does not relieve the give-way vessel of her obligation to keep out of the way.

**RULE 18**

*Responsibilities between vessels*

Except where Rules 9, 10 and 13 otherwise require—

(a) A power-driven vessel underway shall keep out of the way of—

- (i) a vessel not under command;
- (ii) a vessel restricted in her ability to manoeuvre;
- (iii) a vessel engaged in fishing;
- (iv) a sailing vessel.

(b) A sailing vessel underway shall keep out of the way of—

- (i) a vessel not under command;

- (ii) a vessel restricted in her ability to manoeuvre;
- (iii) a vessel engaged in fishing.

(c) A vessel engaged in fishing when underway shall, so far as possible, keep out of the way of—

- (i) a vessel not under command;
- (ii) a vessel restricted in her ability to manoeuvre.

(d) (i) Any vessel other than a vessel not under command or a vessel restricted in her ability to manoeuvre shall, if the circumstances of the case admit, avoid impeding the safe passage of a vessel constrained by her draught, exhibiting the signals in Rule 28;

(ii) A vessel constrained by her draught shall navigate with particular caution having full regard to her special condition.

(e) A seaplane on the water shall, in general, keep well clear of all vessels and avoid impeding their navigation. In circumstances, however, where risk of collision exists, she shall comply with the Rules of this Part.

### Section III. Conduct of vessels in restricted visibility

#### RULE 19

##### *Conduct of vessels in restricted visibility*

(a) This Rule applies to vessels not in sight of one another when navigating in or near an area of restricted visibility.

(b) Every vessel shall proceed at a safe speed adapted to the prevailing circumstances and conditions of restricted visibility. A power-driven vessel shall have her engines ready for immediate manoeuvre.

(c) Every vessel shall have due regard to the prevailing circumstances and conditions of restricted visibility when complying with the Rules of Section I of this Part.

(d) A vessel which detects by radar alone the presence of another vessel shall determine if a close-quarters situation is developing and/or risk of collision exists. If so, she shall take avoiding action in ample time, provided that when such action consists of an alteration of course, so far as possible the following shall be avoided:

- (i) an alteration of course to port for a vessel forward of the beam, other than for a vessel being overtaken;
- (ii) an alteration of course towards a vessel a beam or abaft the beam.

(e) Except where it has been determined that a risk of collision does not exist, every vessel which hears apparently forward of her beam the fog signal of another vessel, or which cannot avoid a close-quarters situation with another vessel forward of her beam, shall reduce her speed to the minimum at which she can be kept on her course. She shall if necessary take all her way off and in any event navigate with extreme caution until danger of collision is over.

---

## PART C—LIGHTS AND SHAPES

### RULE 20

#### *Application*

(a) Rules in this Part shall be complied with in all weathers.

(b) The Rules concerning lights shall be complied with from sunset to sunrise, and during such times no other lights shall be exhibited, except such lights as cannot be mistaken for the lights specified in these Rules or do not impair their visibility or distinctive character, or interfere with the keeping of a proper look-out.

(c) The lights prescribed by these Rules shall, if carried, also be exhibited from sunrise to sunset in restricted visibility and may be exhibited in all other circumstances when it is deemed necessary.

(d) The Rules concerning shapes shall be complied with by day.

(e) The lights and shapes specified in these Rules shall comply with the provisions of Annex I to these Regulations.

### RULE 21

#### *Definitions*

(a) “Masthead light” means a white light placed over the fore and aft centre line of the vessel showing an unbroken light over an arc of the horizon of 225 degrees and so fixed as to show the light from right ahead to 22.5 degrees abaft the beam on either side of the vessel.

(b) “Sidelights” means a green light on the starboard side and a red light on the port side each showing an unbroken light over an arc of the horizon of 112.5 degrees and so fixed as to show the light from the right ahead to 22.5 degrees abaft the beam on its respective side. In a vessel of less than 20 metres in length the sidelights may be combined in one lantern carried on the fore and aft centre line of the vessel.

LAWS OF TRINIDAD AND TOBAGO

MINISTRY OF THE ATTORNEY GENERAL AND LEGAL AFFAIRS

www.legalaffairs.gov.tt

390

Chap. 50:10

Shipping

[Subsidiary]

Shipping (Distress Signals and Prevention of Collisions) Regulations

(c) “Sternlight” means a white light placed as nearly as practicable at the stern showing an unbroken light over an arc of the horizon of 135 degrees and so fixed as to show the light 67.5 degrees from right aft on each side of the vessel.

(d) “Towing light” means a yellow light having the same characteristics as the “sternlight” defined in paragraph (c) of this Rule.

(e) “All-round light” means a light showing an unbroken light over an arc of the horizon of 360 degrees.

(f) “Flashing light” means a light flashing at regular intervals at a frequency of 120 flashes or more per minute.

**RULE 22**

*Visibility of light*

The lights prescribed in these Rules shall have an intensity as specified in section 8 of Annex I to these Regulations so as to be visible at the following minimum ranges:

- (a) In vessels of 50 metres or more in length—
  - a masthead light, 6 miles;
  - a sidelight, 3 miles;
  - a sternlight, 3 miles;
  - a towing light, 3 miles;
  - a white, red, green or yellow all-round light, 3 miles.
- (b) In vessels of 12 metres or more in length but less than 50 metres in length—
  - a masthead light, 5 miles; except that where the length of the vessel is less than 20 metres, 3 miles;
  - a sidelight, 2 miles;
  - a sternlight, 2 miles;
  - a towing light, 2 miles;
  - a white, red, green or yellow all-round light, 2 miles.
- (c) In vessels of less than 12 metres in length—
  - a masthead light, 2 miles;
  - a sidelight, 1 mile;
  - a sternlight, 2 miles;
  - a towing light, 2 miles;
  - a white, red, green or yellow all-round light, 2 miles.
- (d) In inconspicuous, partly submerged vessels or objects towed—
  - a white all-round light, 3 miles.

UNOFFICIAL VERSION

UPDATED TO 31ST DECEMBER 2016

**RULE 23**

*Power-driven vessels underway*

(a) A power-driven vessel underway shall exhibit—

- (i) a masthead light forward;
- (ii) a second masthead light abaft of and higher than the forward one; except that a vessel of less than 50 metres in length shall not be obliged to exhibit such light but may do so;
- (iii) sidelights;
- (iv) a sternlight.

(b) An air-cushion vessel when operating in the non-displacement mode shall, in addition to the lights prescribed in paragraph (a) of this Rule, exhibit an all-round flashing yellow light.

(c) (i) A power-driven vessel of less than 12 metres in length may in lieu of the lights prescribed in paragraph (a) of this Rule exhibit an all-round white light and sidelights;

(ii) A power-driven vessel of less than 7 metres in length whose maximum speed does not exceed 7 knots may in lieu of the lights prescribed in paragraph (a) of this Rule exhibit an all-round white light and shall, if practicable, also exhibit sidelights;

(iii) The masthead light or all-round white light on a power-driven vessel of less than 12 metres in length may be displaced from the fore and aft centreline of the vessel if centreline fitting is not practicable, provided that the sidelights are combined in one lantern which shall be carried on the fore and aft centreline of the vessel or located as nearly as practicable in the same fore and aft line as the masthead light or the all-round white light.

**RULE 24**

*Towing and pushing*

(a) A power-driven vessel when towing shall exhibit—

- (i) instead of the light prescribed in Rule 23(a)(i) or (a)(ii), two masthead lights in a vertical line. When the length of the tow, measuring from the stern of the towing vessel to the after end of the tow exceeds 200 metres, three such lights in a vertical line;
- (ii) sidelights;
- (iii) a sternlight;

- (iv) a towing light in a vertical line above the sternlight;
- (v) when the length of the tow exceeds 200 metres, a diamond shape where it can best be seen.

(b) When a pushing vessel and a vessel being pushed ahead are rigidly connected in a composite unit they shall be regarded as a power-driven vessel and exhibit the lights prescribed in Rule 23.

(c) A power-driven vessel when pushing ahead or towing alongside, except in the case of a composite unit, shall exhibit—

- (i) instead of the light prescribed in Rule 23(a)(i) or (a)(ii), two masthead lights in a vertical line;
- (ii) sidelights;
- (iii) a sternlight.

(d) A power-driven vessel to which paragraph (a) or (c) of this Rule apply shall also comply with Rule 23(a)(ii).

(e) A vessel or object being towed, other than those mentioned in paragraph (g) of this Rule, shall exhibit—

- (i) sidelights;
- (ii) a sternlight;
- (iii) when the length of the tow exceeds 200 metres, a diamond shape where it can best be seen.

(f) Provided that any number of vessels being towed alongside or pushed in a group shall be lighted as one vessel—

- (i) a vessel being pushed ahead, not being part of a composite unit, shall exhibit at the forward end, sidelights;
- (ii) a vessel being towed alongside shall exhibit a sternlight and at the forward end, sidelights.

(g) An inconspicuous, partly submerged vessel or object, or combination of such vessels or objects being towed, shall exhibit—

- (i) if it is less than 25 metres in breadth, one all-round white light at or near the forward end and one at or near the after end except that dracones need not exhibit a light at or near the forward end;
- (ii) if it is 25 metres or more in breadth, two additional all-round white lights at or near the extremities of its breadth;
- (iii) if it exceeds 100 metres in length, additional all-round white lights between the lights prescribed in subparagraphs (i) and (ii) so that the distance between the lights shall not exceed 100 metres;

- (iv) a diamond shape at or near the aftermost extremity of the last vessel or object being towed and if the length of the tow exceeds 200 metres an additional diamond shape where it can best be seen and located as far forward as is practicable.

(h) Where from any sufficient cause it is impracticable for a vessel or object being towed to exhibit the lights or shapes prescribed in paragraph (e) or (g) of this Rule, all possible measures shall be taken to light the vessel or object towed or at least to indicate the presence of such vessel or object.

(i) Where from any sufficient cause it is impracticable for a vessel not normally engaged in towing operations to display the lights prescribed in paragraph (a) or (c) of this Rule, such vessel shall not be required to exhibit those lights when engaged in towing another vessel in distress or otherwise in need of assistance. All possible measures shall be taken to indicate the nature of the relationship between the towing vessel and the vessel being towed as authorised by Rule 36, in particular by illuminating the towline.

#### **RULE 25**

##### *Sailing vessels underway and vessels under oars*

- (a) A sailing vessel underway shall exhibit:
  - (i) sidelights;
  - (ii) a sternlight.

(b) In a sailing vessel of less than 20 metres in length the lights prescribed in paragraph (a) of this Rule may be combined in one lantern carried at or near the top of the mast where it can best be seen.

(c) A sailing vessel underway may, in addition to the lights prescribed in paragraph (a) of this Rule, exhibit at or near the top of the mast, where they can best be seen, two all-round lights in a vertical line, the upper being red and the lower green, but these lights shall not be exhibited in conjunction with the combined lantern permitted by paragraph (b) of this Rule.

(d) (i) A sailing vessel of less than 7 metres in length shall, if practicable, exhibit the lights prescribed in paragraph (a) or (b) of this Rule, but if she does not, she shall have ready at hand an electric torch or lighted lantern showing a white light which shall be exhibited in sufficient time to prevent collision.

(ii) A vessel under oars may exhibit the lights prescribed in this Rule for sailing vessels, but if she does not, she shall have ready at hand an electric torch or lighted lantern showing a white light which shall be exhibited in sufficient time to prevent collision.

**LAWS OF TRINIDAD AND TOBAGO**

MINISTRY OF THE ATTORNEY GENERAL AND LEGAL AFFAIRS

www.legalaffairs.gov.tt

394

**Chap. 50:10**

*Shipping*

[Subsidiary]

*Shipping (Distress Signals and Prevention of Collisions) Regulations*

(e) A vessel proceeding under sail when also being propelled by machinery shall exhibit forward where it can best be seen a conical shape, apex downwards.

**RULE 26**

*Fishing vessels*

(a) A vessel engaged in fishing, whether underway or at anchor, shall exhibit only the lights and shapes prescribed in this Rule.

(b) A vessel when engaged in trawling, by which is meant the dragging through the water of a dredge net or other apparatus used as a fishing appliance, shall exhibit—

- (i) two all-round lights in a vertical line, the upper being green and the lower white, or a shape consisting of two cones with their apexes together in a vertical line one above the other; a vessel of less than 20 metres in length may instead of this shape exhibit a basket;
- (ii) a masthead light abaft of and higher than the all-round green light; a vessel of less than 50 metres in length shall not be obliged to exhibit such a light but may do so;
- (iii) when making way through the water, in addition to the lights prescribed in this paragraph, sidelights and a sternlight.

(c) A vessel engaged in fishing, other than trawling, shall exhibit—

- (i) two all-round lights in a vertical line, the upper being red and the lower white, or a shape consisting of two cones with apexes together in a vertical line one above the other; a vessel of less than 20 metres in length may instead of this shape exhibit a basket;
- (ii) when there is outlying gear extending more than 150 metres horizontally from the vessel, an all-round white light or a cone apex upwards in the direction of the gear;
- (iii) when making way through the water, in addition to the lights prescribed in this paragraph, sidelights and a sternlight.

(d) A vessel engaged in fishing in close proximity to other vessels engaged in fishing may exhibit the additional signals described in Annex II to these Regulations.

(e) A vessel when not engaged in fishing shall not exhibit the lights or shapes prescribed in this Rule, but only those prescribed for a vessel of her length.

UNOFFICIAL VERSION

UPDATED TO 31ST DECEMBER 2016

**RULE 27**

*Vessels not under command or restricted in their ability to manoeuvre*

(a) A vessel not under command shall exhibit—

- (i) two all-round red lights in a vertical line where they can best be seen;
- (ii) two balls or similar shapes in a vertical line where they can best be seen;
- (iii) when making way through the water, in addition to the lights prescribed in this paragraph, sidelights and a sternlight.

(b) A vessel restricted in her ability to manoeuvre, except a vessel engaged in mine-clearance operations, shall exhibit—

- (i) three all-round lights in a vertical line where they can best be seen. The highest and lowest of these lights shall be red and the middle light shall be white;
- (ii) three shapes in a vertical line where they can best be seen. The highest and lowest of these shapes shall be balls and the middle one a diamond;
- (iii) when making way through the water, a masthead light or lights, sidelights and a sternlight, in addition to the lights prescribed in subparagraph (i);
- (iv) when at anchor, in addition to the lights or shapes prescribed in subparagraphs (i) and (ii), the light, lights or shape prescribed in Rule 30.

(c) A power-driven vessel engaged in a towing operation such as severely restricts the towing vessel and her tow in their ability to deviate from their course shall, in addition to the lights or shapes prescribed in Rule 24(a), exhibit the lights or shapes prescribed in subparagraphs (b)(i) and (ii) of this Rule.

(d) A vessel engaged in dredging or underwater operations, when restricted in her ability to manoeuvre, shall exhibit the lights and shapes prescribed in subparagraphs (b)(i), (ii) and (iii) of this Rule and shall in addition, when an obstruction exists, exhibit—

- (i) two all-round red lights or two balls in a vertical line to indicate the side on which the obstruction exists;
- (ii) two all-round green lights or two diamonds in a vertical line to indicate the side on which another vessel may pass;
- (iii) when at anchor, the lights or shapes prescribed in this paragraph instead of the lights or shape prescribed in Rule 30.

(e) Whenever the size of a vessel engaged in diving operations makes it impracticable to exhibit all lights and shapes prescribed in paragraph (d) of this Rule, the following shall be exhibited:

- (i) three all-round lights in a vertical line where they can best be seen. The highest and lowest of these lights shall be red and the middle light shall be white;
- (ii) a rigid replica of the International Code flag "A" not less than one metre in height. Measures shall be taken to ensure its all-round visibility.

(f) A vessel engaged in mine-clearance operations shall in addition to the lights prescribed for a power-driven vessel in Rule 23 or to the lights or shape prescribed for a vessel at anchor in Rule 30 as appropriate, exhibit three all-round green lights or three balls. One of these lights or shapes shall be exhibited near the foremast head and one at each end of the fore yard. These lights or shapes indicate that it is dangerous for another vessel to approach within 1000 metres of the mine-clearance vessel.

(g) Vessels of less than 12 metres in length, except those engaged in diving operations, shall not be required to exhibit the lights and shapes prescribed in this Rule.

(h) The signals prescribed in this Rule are not signals of vessels in distress and requiring assistance. Such signals are contained in Annex IV to these Regulations.

#### **RULE 28**

##### *Vessels constrained by their draught*

A vessel constrained by her draught may, in addition to the lights prescribed for power-driven vessels in Rule 23, exhibit where they can best be seen three all-round red lights in a vertical line, or a cylinder.

#### **RULE 29**

##### *Pilot vessels*

- (a) A vessel engaged on pilotage duty shall exhibit—
- (i) at or near the masthead, two all-round lights in a vertical line, the upper being white and the lower red;
  - (ii) when underway, in addition, sidelights and a sternlight;
  - (iii) when at anchor, in addition to the lights prescribed in subparagraph (i), the light, lights or shape prescribed in Rule 30 for vessels at anchor.

(b) A pilot vessel when not engaged on pilotage duty shall exhibit the lights or shapes prescribed for a similar vessel of her length.

**RULE 30**

*Anchored vessels and vessels aground*

(a) A vessel at anchor shall exhibit where it can best be seen—

- (i) in the fore part, an all-round white light or one ball;
- (ii) at or near the stem and at a lower level than the light prescribed in subparagraph (i), an all-round white light.

(b) A vessel of less than 50 metres in length may exhibit an all-round white light where it can best be seen instead of the lights prescribed in paragraph (a) of this Rule.

(c) A vessel at anchor may, and a vessel of 100 metres and more in length shall, also use the available working or equivalent lights to illuminate her decks.

(d) A vessel aground shall exhibit the lights prescribed in paragraph (a) or (b) of this Rule and in addition, where they can best be seen—

- (i) two all-round red lights in a vertical line;
- (ii) three balls in a vertical line.

(e) A vessel of less than 7 metres in length, when at anchor, not in or near a narrow channel, fairway or anchorage, or where other vessels normally navigate, shall not be required to exhibit the lights or shape prescribed in paragraphs (a) and (b) of this Rule.

(f) A vessel of less than 12 metres in length, when aground, shall not be required to exhibit the lights or shapes prescribed in subparagraph (d)(i) and (ii) of this Rule.

**RULE 31**

*Seaplanes*

Where it is impracticable for a seaplane to exhibit lights and shapes of the characteristics or in the positions prescribed in the Rules of this Part she shall exhibit lights and shapes as closely similar in characteristics and position as is possible.

## PART D—SOUND AND LIGHT SIGNALS

## RULE 32

*Definitions*

(a) The word “whistle” means any sound signalling appliance capable of producing the prescribed blasts and which complies with the specifications in Annex III to these Regulations.

(b) The term “short blast” means a blast of about one second’s duration.

(c) The term “prolonged blast” means a blast of from four to six seconds’ duration.

## RULE 33

*Equipment for sound signals*

(a) A vessel of 12 metres or more in length shall be provided with a whistle and a bell and a vessel of 100 metres or more in length shall, in addition, be provided with a gong, the tone and sound of which cannot be confused with that of the bell. The whistle, bell and gong shall comply with the specifications in Annex III to these Regulations. The bell or gong or both may be replaced by other equipment having the same respective sound characteristics, provided that manual sounding of the prescribed signals shall always be possible.

(b) A vessel of less than 12 metres in length shall not be obliged to carry the sound signalling appliances prescribed in paragraph (a) of this Rule but if she does not, she shall be provided with some other means of making an efficient sound signal.

## RULE 34

*Manoeuvring and warning signals*

(a) When vessels are in sight of one another, a power-driven vessel underway, when manoeuvring as authorised or required by these Rules, shall indicate that manoeuvre by the following signals on her whistle:

one short blast to mean “I am altering my course to starboard”;

two short blasts to mean “I am altering my course to port”;

three short blasts to mean “I am operating astern propulsion”.

(b) Any vessel may supplement the whistle signals prescribed in paragraph (a) of this Rule by light signals, repeated as appropriate, whilst the manoeuvre is being carried out—

(i) these light signals shall have the following significance:

one flash to mean “I am altering my course to starboard”;

two flashes to mean “I am altering my course to port”;

three flashes to mean “I am operating astern propulsion”;

- (ii) the duration of each flash shall be about one second, the interval between flashes shall be about one second, and the interval between successive signals shall be not less than ten seconds;
- (iii) the light used for this signal shall, if fitted, be an all-round white light, visible at a minimum range of 5 miles, and shall comply with the provisions of Annex I to these Regulations.

(c) When in sight of one another in a narrow channel or fairway—

- (i) a vessel intending to overtake another shall in compliance with Rule 9(e)(i) indicate her intention by the following signals on her whistle:

two prolonged blasts followed by one short blast to mean  
“I intend to overtake you on your starboard side”;

two prolonged blasts followed by two short blasts to mean  
“I intend to overtake you on your port side”;

- (ii) the vessel about to be overtaken when acting in accordance with Rule 9(e)(i) shall indicate her agreement by the following signal on her whistle:

one prolonged, one short, one prolonged and one short blast, in that order.

(d) When vessels in sight of one another are approaching each other and from any cause either vessel fails to understand the intentions or actions of the other, or is in doubt whether sufficient action is being taken by the other to avoid collision, the vessel in doubt shall immediately indicate such doubt by giving at least five short and rapid blasts on the whistle. Such signal may be supplemented by a light signal of at least five short and rapid flashes.

(e) A vessel nearing a bend or an area of a channel or fairway where other vessels may be obscured by an intervening obstruction shall sound one prolonged blast. Such signal shall be answered with a prolonged blast by any approaching vessel that may be within hearing around the bend or behind the intervening obstruction.

(f) If whistles are fitted on a vessel at a distance apart of more than 100 metres, one whistle only shall be used for giving manoeuvring and warning signals.

#### **RULE 35**

##### *Sound signals in restricted visibility*

In or near an area of restricted visibility, whether by day or night, the signals prescribed in this Rule shall be used as follows:

(a) A power-driven vessel making way through the water shall sound at intervals of not more than 2 minutes one prolonged blast.

**LAWS OF TRINIDAD AND TOBAGO**

MINISTRY OF THE ATTORNEY GENERAL AND LEGAL AFFAIRS

www.legalaffairs.gov.tt

400

**Chap. 50:10**

*Shipping*

**[Subsidiary]**

*Shipping (Distress Signals and Prevention of Collisions) Regulations*

(b) A power-driven vessel underway but stopped and making no way through the water shall sound at intervals of not more than 2 minutes two prolonged blasts in succession with an interval of about 2 seconds between them.

(c) A vessel not under command, a vessel restricted in her ability to manoeuvre, a vessel constrained by her draught, a sailing vessel, a vessel engaged in fishing and a vessel engaged in towing or pushing another vessel shall, instead of the signals prescribed in paragraph (a) or (b) of this Rule, sound at intervals of not more than 2 minutes three blasts in succession, namely one prolonged followed by two short blasts.

(d) A vessel engaged in fishing, when at anchor, and a vessel restricted in her ability to manoeuvre when carrying out her work at anchor, shall instead of the signals prescribed in paragraph (g) of this Rule sound the signal prescribed in paragraph (c) of this Rule.

(e) A vessel towed or if more than one vessel is towed the last vessel of the tow, if manned, shall at intervals of not more than 2 minutes sound four blasts in succession, namely one prolonged followed by three short blasts. When practicable, this signal shall be made immediately after the signal made by the towing vessel.

(f) When a pushing vessel and a vessel being pushed ahead are rigidly connected in a composite unit they shall be regarded as a power-driven vessel and shall give the signals prescribed in paragraph (a) or (b) of this Rule.

(g) A vessel at anchor shall at intervals of not more than one minute ring the bell rapidly for about 5 seconds. In a vessel of 100 metres or more in length the bell shall be sounded in the forepart of the vessel and immediately after the ringing of the bell the gong shall be sounded rapidly for about 5 seconds in the after part of the vessel. A vessel at anchor may in addition sound three blasts in succession, namely one short, one prolonged and one short blast, to give warning of her position and of the possibility of collision to an approaching vessel.

(h) A vessel aground shall give the bell signal and if required the gong signal prescribed in paragraph (g) of this Rule and shall, in addition, give three separate and distinct strokes on the bell immediately before and after the rapid ringing of the bell. A vessel aground may in addition sound an appropriate whistle signal.

(i) A vessel of less than 12 metres in length shall not be obliged to give the above-mentioned signals but, if she does not, shall make some other efficient sound signal at intervals of not more than 2 minutes.

UNOFFICIAL VERSION

UPDATED TO 31ST DECEMBER 2016

(j) A pilot vessel when engaged on pilotage duty may in addition to the signals prescribed in paragraph (a), (b) or (g) of this Rule sound an identity signal consisting of four short blasts.

**RULE 36**

*Signals to attract attention*

If necessary to attract the attention of another vessel any vessel may make light or sound signals that cannot be mistaken for any signal authorised elsewhere in these Rules, or may direct the beam of her searchlight in the direction of the danger, in such a way as not to embarrass any vessel. Any light to attract the attention of another vessel shall be such that it cannot be mistaken for any aid to navigation. For the purpose of this Rule the use of high intensity intermittent or revolving lights, such as strobe lights, shall be avoided.

**RULE 37**

*Distress signals*

When a vessel is in distress and requires assistance she shall use or exhibit the signals described in Annex IV to these Regulations.

**PART E—EXEMPTIONS**

**RULE 38**

*Exemptions*

Any vessel (or class of vessels) provided that she complies with the requirements of the International Regulations for Preventing Collisions at Sea, 1960, the keel of which is laid or which is at a corresponding stage of construction before the entry into force of these Regulations may be exempted from compliance therewith as follows:

(a) The installation of lights with ranges prescribed in Rule 22, until four years after the date of entry into force of these Regulations.

(b) The installation of lights with colour specifications as prescribed in section 7 of Annex I to these Regulations, until four years after the date of entry into force of these Regulations.

(c) The repositioning of lights as a result of conversion from Imperial to metric units and rounding off measurement figures, permanent exemption.

**LAWS OF TRINIDAD AND TOBAGO**

MINISTRY OF THE ATTORNEY GENERAL AND LEGAL AFFAIRS

www.legalaffairs.gov.tt

402

**Chap. 50:10**

*Shipping*

**[Subsidiary]**

*Shipping (Distress Signals and Prevention of Collisions) Regulations*

(d) (i) The repositioning of masthead lights on vessels of less than 150 metres in length, resulting from the prescriptions of section 3(a) of Annex I to these Regulations, permanent exemption.

(ii) The repositioning of masthead lights on vessels of 150 metres or more in length, resulting from the prescriptions of section 3(a) of Annex I to these Regulations, until nine years after the date of entry into force of these Regulations.

(e) The repositioning of masthead lights resulting from the prescriptions of section 2(b) of Annex I to these Regulations, until nine years after the date of entry into force of these Regulations.

(f) The repositioning of sidelights resulting from the prescriptions of sections 2(g) and 3(b) of Annex I to these Regulations, until nine years after the date of entry into force of these Regulations.

(g) The requirements for sound signal appliances prescribed in Annex III to these Regulations, until nine years after the date of entry into force of these Regulations.

(h) The repositioning of all-round lights resulting from the prescription of section 9(b) of Annex I to these Regulations, permanent exemption.

---

**ANNEX I**

**Positioning and technical details of lights and shapes**

*1. Definition*

The term “height above the hull” means height above the uppermost continuous deck. This height shall be measured from the position vertically beneath the location of the light.

*2. Vertical positioning and spacing of lights*

(a) On a power-driven vessel of 20 metres or more in length the masthead lights shall be placed as follows:

(i) the forward masthead light, or if only one masthead light is carried, then that light, at a height above the hull of not less than 6 metres, and, if the breadth of the vessel exceeds 6 metres, then at a height above the hull not less than such breadth, so however that the light need not be placed at a greater height above the hull than 12 metres;

UNOFFICIAL VERSION

UPDATED TO 31ST DECEMBER 2016

- (ii) when two masthead lights are carried the after one shall be at least 4-5 metres vertically higher than the forward one.

(b) The vertical separation of masthead lights of power-driven vessels shall be such that in all normal conditions of trim the after light will be seen over and separate from the forward light at a distance of 1,000 metres from the stern when viewed from sea-level.

(c) The masthead light of a power-driven vessel of 12 metres but less than 20 metres in length shall be placed at a height above the gunwale of not less than 2.5 metres.

(d) A power-driven vessel of less than 12 metres in length may carry the uppermost light at a height of less than 2.5 metres above the gunwale. When however a masthead light is carried in addition to sidelights and a sternlight or the all-round light prescribed in Rule 23(c)(i) is carried in addition to sidelights, then such masthead light or all-round light shall be carried at least 1 metre higher than the sidelights.

(e) One of the two or three masthead lights prescribed for a power-driven vessel when engaged in towing or pushing another vessel shall be placed in the same position as either the forward masthead light or the after masthead light; provided that, if carried on the aftermast, the lowest after masthead light shall be at least 4.5 metres vertically higher than the forward masthead light.

(f) (i) The masthead light or lights prescribed in rule 23(a) shall be so placed as to be above and clear of all other lights and obstructions except as described in subparagraph (ii).

(ii) When it is impracticable to carry the all-round lights prescribed by rule 27(b)(i) or rule 28 below the masthead lights, they may be carried above the after masthead light(s) or vertically in between the forward masthead light(s) and the after masthead light(s), provided that in the latter case the requirement of section 3(c) of this Annex shall be complied with.

(g) The sidelights of a power-driven vessel shall be placed at a height above the hull not greater than three-quarters of that of the forward masthead light. They shall not be so low as to be interfered with by deck lights.

(h) The sidelights, if in a combined lantern and carried on a power-driven vessel of less than 20 metres in length, shall be placed not less than one metre below the masthead light.

(i) When the Rules prescribe two or three lights to be carried in a vertical line, they shall be spaced as follows:

- (i) on a vessel of 20 metres in length or more such lights shall be spaced not less than 2 metres apart, and the lowest of these lights shall, except where a towing light is required, be placed at a height of not less than 4 metres above the hull;
- (ii) on a vessel of less than 20 metres in length such lights shall be spaced not less than 1 metre apart and the lowest of these lights shall, except where a towing light is required be placed at a height of not less than 2 metres above the gunwale;
- (iii) when three lights are carried they shall be equally spaced.

(j) The lower of the two all-round lights prescribed for a vessel when engaged in fishing shall be at a height above the sidelights not less than twice the distance between the two vertical lights.

(k) The forward anchor light prescribed in rule 30(a)(i), when two are carried, shall not be less than 4.5 metres above the after one. On a vessel of 50 metres or more in length this forward anchor light shall be placed at a height of not less than 6 metres above the hull.

### 3. *Horizontal positioning and spacing of lights*

(a) When two masthead lights are prescribed for a power-driven vessel, the horizontal distance between them shall not be less than one-half of the length of the vessel but need not be more than 100 metres. The forward light shall be placed not more than one-quarter of the length of the vessel from the stern.

(b) On a power-driven vessel of 20 metres or more in length the sidelights shall not be placed in front of the forward masthead lights. They shall be placed at or near the side of the vessel.

(c) When the lights prescribed in rule 27(b)(i) or rule 28 are placed vertically between the forward masthead light(s) and the after masthead light(s) these all-round lights shall be placed at a horizontal distance of not less than 2 metres from the fore and aft centreline of the vessels in the athwartship direction.

### 4. *Details of location of direction-indicating lights for fishing vessels, dredgers and vessels engaged in underwater operations.*

(a) The light indicating the direction of the outlying gear from a vessel engaged in fishing as prescribed in rule 26(c)(ii) shall be placed at a horizontal

distance of not less than 2 metres and not more than 6 metres away from the two all-round red and white lights. This light shall be placed not higher than the all-round white light prescribed in rule 26(c)(i) and not lower than the sidelights.

(b) The lights and shapes on a vessel engaged in dredging or underwater operations to indicate the obstructed side and/or the side on which it is safe to pass, as prescribed in rule 27(d)(i) and (ii), shall be placed at the maximum practical horizontal distance, but in no case less than 2 metres, from the lights or shapes prescribed in rule 27(b)(i) and (ii). In no case shall the upper of these lights or shapes be at a greater height than the lower of the three lights or shapes prescribed in rule 27(b)(i) and (ii).

#### 5. Screens for sidelights

The sidelights of vessels of 20 metres or more in length shall be fitted with inboard screens painted matt black, and meeting the requirements of section 9 of this Annex. On vessels of less than 20 metres in length the sidelights, if necessary to meet the requirements of section 9 of this Annex, shall be fitted with inboard matt black screens. With a combined lantern, using a single vertical filament and a very narrow division between the green and red sections, external screens need not be fitted.

#### 6. Shapes

(a) Shapes shall be black and of the following sizes:

- (i) a ball shall have a diameter of not less than 0.6 metre;
- (ii) a cone shall have a base diameter of not less than 0.6 metre and a height equal to its diameter;
- (iii) a cylinder shall have a diameter of at least 0.6 metre and a height of twice its diameter;
- (iv) a diamond shape shall consist of two cones as defined in (ii) above having a common base.

(b) The vertical distance between shapes shall be at least 1.5 metres.

(c) In a vessel of less than 20 metres in length shapes of lesser dimensions but commensurate with the size of the vessel may be used and the distance apart may be correspondingly reduced.

#### 7. Colour specification of lights

The chromaticity of all navigation lights shall conform to the following standards, which lie within the boundaries of the area of the diagram specified for each colour by the International Commission on Illumination (CIE).

**LAWS OF TRINIDAD AND TOBAGO**

MINISTRY OF THE ATTORNEY GENERAL AND LEGAL AFFAIRS

www.legalaffairs.gov.tt

406

**Chap. 50:10**

*Shipping*

**[Subsidiary]**

*Shipping (Distress Signals and Prevention of Collisions) Regulations*

The boundaries of the area for each colour are given by indicating the corner co-ordinates, which are as follows:

(i) *White*

x	0.525	0.525	0.452	0.310	0.310	0.443
y	0.382	0.440	0.440	0.348	0.283	0.382

(ii) *Green*

x	0.028	0.009	0.300	0.203
y	0.385	0.723	0.511	0.356

(iii) *Red*

x	0.680	0.660	0.735	0.721
y	0.320	0.320	0.265	0.259

(iv) *Yellow*

x	0.612	0.618	0.575	0.576
y	0.382	0.382	0.425	0.406

**8. Intensity of lights**

(a) The minimum luminous intensity of lights shall be calculated by using the formula—

$$I = 3.43 \times 10^6 \times T \times D^2 \times K - D.$$

where I is luminous intensity in candelas under service conditions,

T is threshold factor  $2 \times 10^{-7}$  lux,

D is range of visibility (luminous range) of the light in nautical miles,

K is atmospheric transmissivity.

For prescribed lights the value of K shall be 0.8, corresponding to a meteorological visibility of approximately 13 nautical miles.

(b) A selection of figures derived from the formula is given in the following Table:

<i>Range of visibility (luminous range) of light in nautical miles</i>	<i>Luminous intensity of light in candelas for K=0.8</i>
D	I
1	0.9
2	4.3
3	12
4	27
5	52
6	94

*Note:* The maximum luminous intensity of navigation lights should be limited to avoid undue glare. This shall not be achieved by a variable control of the luminous intensity.

UNOFFICIAL VERSION

UPDATED TO 31ST DECEMBER 2016

9. *Horizontal sectors*

(a) (i) In the forward direction, sidelights as fitted on the vessel shall show the minimum required intensities. The intensities shall decrease to reach practical cut-off between 1 degree and 3 degrees outside the prescribed sectors.

(ii) For sternlights and masthead lights and at 22.5 degrees abaft the beam for sidelights, the minimum required intensities shall be maintained over the arc of the horizon up to 5 degrees within the limits of the sectors prescribed in rule 21. From 5 degrees within the prescribed sectors the intensity may decrease by 50 per cent up to the prescribed limits; it shall decrease steadily to reach practical cut-off at not more than 5 degrees outside the prescribed sectors.

(b) All-round lights shall be so located as not to be obscured by masts, topmasts or structures within angular sectors of more than 6 degrees, except anchor lights prescribed in rule 30, which need not be placed at an impractical height above the hull.

10. *Vertical sectors*

(a) The vertical sectors of electric lights as fitted, with the exception of lights on sailing vessels underway shall ensure that—

- (i) at least the required minimum intensity is maintained at all angles from 5 degrees above to 5 degrees below the horizontal;
- (ii) at least 60 per cent of the required minimum intensity is maintained from 7.5 degrees above to 7.5 degrees below the horizontal.

(b) In the case of sailing vessels underway the vertical sectors of electric lights as fitted shall ensure that—

- (i) at least the required minimum intensity is maintained at all angles from 5 degrees above to 5 degrees below the horizontal;
- (ii) at least 50 per cent of the required minimum intensity is maintained from 25 degrees above to 25 degrees below the horizontal.

(c) In the case of lights other than electric these specifications shall be met as closely as possible.

11. *Intensity of non-electric lights*

Non-electric lights shall so far as practicable comply with the minimum intensities, as specified in the Table given in section 8 of this Annex.

12. *Manoeuvring light*

Notwithstanding the provisions of paragraph 2(f) of this Annex the manoeuvring light described in rule 34(b) shall be placed in the same fore and

aft vertical plane as the masthead light or lights and, where practicable, at a minimum height of 2 metres vertically above the forward masthead light, provided that it shall be carried not less than 2 metres vertically above or below the after masthead light. On a vessel where only one masthead light is carried the manoeuvring light, if fitted, shall be carried where it can best be seen, not less than 2 metres vertically apart from the masthead light.

### 13. Approval

The construction of lights and shapes and the installation of lights on board the vessel shall be to the satisfaction of the appropriate authority of the State whose flag the vessel is entitled to fly.

## ANNEX II

### Additional signals for fishing vessels fishing in close proximity

#### 1. General

The lights mentioned herein shall, if exhibited in pursuance of rule 26(d), be placed where they can best be seen. They shall be at least 0.9 metre apart but at a lower level than lights prescribed in rule 26(b)(i) and (c)(i). The lights shall be visible all round the horizon at a distance of at least 1 mile but at a lesser distance than the lights prescribed by these Rules for fishing vessels.

#### 2. Signals for trawlers

(a) Vessels when engaged in trawling, whether using demersal or pelagic gear, may exhibit—

- (i) when shooting their nets—  
two white lights in a vertical line;
- (ii) when hauling their nets—  
one white light over one red light in a vertical line;
- (iii) when the net has come fast upon an obstruction—  
two red lights in a vertical line.

(b) Each vessel engaged in pair trawling may exhibit—

- (i) by night, a searchlight directed forward and in the direction of the other vessel of the pair;
- (ii) when shooting or hauling their nets or when their nets have come fast upon an obstruction, the lights prescribed in 2(a) above.

3. *Signals for purse seiners*

Vessels engaged in fishing with purse seine gear may exhibit two yellow lights in a vertical line. These lights shall flash alternately every second and with equal light and occultation duration. These lights may be exhibited only when the vessel is hampered by its fishing gear.

**ANNEX III**

**Technical details of sound signal appliances**

1. *Whistles*

(a) *Frequencies and range of audibility*

The fundamental frequency of the signal shall lie within the range 70–700 Hz.

The range of audibility of the signal from a whistle shall be determined by those frequencies, which may include the fundamental and/or one or more higher frequencies, which lie within the range 180–700 Hz ( $\pm 1$  per cent) and which provide the sound pressure levels specified in paragraph 1(c) below.

(b) *Limits of fundamental frequencies*

To ensure a wide variety of whistle characteristics, the fundamental frequency of a whistle shall be between the following limits:

- (i) 70–200 Hz, for a vessel 200 metres or more in length;
- (ii) 130–350 Hz, for a vessel 75 metres but less than 200 metres in length;
- (iii) 250–700 Hz, for a vessel less than 75 metres in length.

(c) *Sound signal intensity and range of audibility*

A whistle fitted in a vessel shall provide, in the direction of maximum intensity of the whistle and at a distance of 1 metre from it, a sound pressure level in at least one  $\frac{1}{3}$  rd-octave band within the range of frequencies 180–700 Hz ( $\pm 1$  per cent) of not less than the appropriate figure given in the table below.

<i>Length of vessel in metres</i>	<i><math>\frac{1}{3}</math> rd-octave band level at 1 metre in dB referred to <math>2 \times 10^5 - N/m^2</math></i>	<i>Audibility range in nautical miles</i>
200 or more	... 143	2
75 but less than 200	... 138	1.5
20 but less than 75	... 130	1
Less than 20	... 120	0.5

The range of audibility in the table above is for information and is approximately the range at which a whistle may be heard on its forward axis with 90 per cent probability in conditions of still air on board a vessel having average background noise level at the listening posts (taken to be 68 dB in the octave band centred on 250 Hz and 63 dB in the octave band centred on 500 Hz).

In practice the range at which a whistle may be heard is extremely variable and depends critically on weather conditions; the values given can be regarded as typical but under conditions of strong wind or high ambient noise level at the listening post the range may be much reduced.

*(d) Directional properties*

The sound pressure level of a directional whistle shall be not more than 4 dB below the prescribed sound pressure level on the axis at any direction in the horizontal plane within  $\pm 45$  degrees of the axis. The sound pressure level at any other direction in the horizontal plane shall be not more than 10 dB below the prescribed sound pressure level on the axis, so that the range in any direction will be at least half the range on the forward axis. The sound pressure level shall be measured in that  $\frac{1}{3}$  rd-octave band which determines the audibility range.

*(e) Positioning of whistles*

When a directional whistle is to be used as the only whistle on a vessel, it shall be installed with its maximum intensity directed straight ahead.

A whistle shall be placed as high as practicable on a vessel, in order to reduce interception of the emitted sound by obstructions and also to minimize hearing damage risk to personnel. The sound pressure level of the vessel's own signal at listening posts shall not exceed 110 dB(A) and so far as practicable should not exceed 100 dB(A).

*(f) Fitting of more than one whistle*

If whistles are fitted at a distance apart of more than 100 metres, it shall be so arranged that they are not sounded simultaneously.

*(g) Combined whistle systems*

If due to the presence of obstructions the sound field of a single whistle or of one of the whistles referred to in paragraph 1(f) above is likely to have a zone of greatly reduced signal level, it is recommended that a combined whistle system be fitted so as to overcome this reduction. For the purposes of the Rules a combined whistle system is to be regarded as a single whistle. The whistles of a combined system shall be located at a distance apart of not more than 100 metres and arranged to be sounded simultaneously. The frequency of any one whistle shall differ from those of the others by at least 10 Hz.

2. *Bell or gong*

(a) *Intensity of signal*

A bell or gong, or other device having similar sound characteristics shall produce a sound pressure level of not less than 110 dB at a distance of 1 metre from it.

(b) *Construction*

Bells and gongs shall be made of corrosion-resistant material and designed to give a clear tone. The diameter of the mouth of the bell shall be not less than 300 mm for vessels of 20 metres or more in length and shall be not less than 200 mm for vessels of 12 metres or more but of less than 20 metres in length.

Where practicable, a power-driven bell striker is recommended to ensure constant force but manual operation shall be possible. The mass of the striker shall be not less than 3 per cent of the mass of the bell.

3. *Approval*

The construction of sound signal appliances, their performance and their installation on board the vessel shall be to the satisfaction of the appropriate authority of the State whose flag the vessel is entitled to fly.

---

**ANNEX IV**

**Distress signals**

1. The following signals, used or exhibited either together or separately, indicate distress and need of assistance:

- (a) a gun or other explosive signal fired at intervals of about a minute;
- (b) a continuous sounding with any fog-signalling apparatus;
- (c) rockets or shells, throwing red stars fired one at a time at short intervals;
- (d) a signal made by radiotelegraphy or by any other signalling method consisting of the group ..... (SOS) in the Morse Code;
- (e) a signal sent by radiotelephony consisting of the spoken word "Mayday";
- (f) the International Code Signal of distress indicated by N.C.;
- (g) a signal consisting of a square flag having above or below it a ball or anything resembling a ball;
- (h) flames on the vessel (as from a burning tar barrel, oil barrel, etc.);
- (i) a rocket parachute flare or a hand flare showing a red light;

**LAWS OF TRINIDAD AND TOBAGO**

MINISTRY OF THE ATTORNEY GENERAL AND LEGAL AFFAIRS

www.legalaffairs.gov.tt

412

**Chap. 50:10**

*Shipping*

**[Subsidiary]**

*Shipping (Distress Signals and Prevention of Collisions) Regulations*

- (j) a smoke signal giving off orange-coloured smoke;
- (k) slowly and repeatedly raising and lowering arms outstretched to each side;
- (l) the radiotelegraph alarm signal;
- (m) the radiotelephone alarm signal;
- (n) signals transmitted by emergency position-indicating radio beacons;
- (o) approved signals transmitted by radiocommunication systems.

2. The use or exhibition of any of the foregoing signals except for the purpose of indicating distress and need of assistance and the use of other signals which may be confused with any of the above signals is prohibited.

3. Attention is drawn to the relevant sections of the International Code of Signals, the Merchant Ship Search and Rescue Manual and the following signals:

- (a) a piece of orange-coloured canvas with either a black square and circle or other appropriate symbol (for identification from the air);
- (b) a dye marker.

---

UNOFFICIAL VERSION

UPDATED TO 31ST DECEMBER 2016

**SHIPPING (LOCAL PASSENGER SHIP) (SAFETY)  
REGULATIONS**

ARRANGEMENT OF REGULATIONS

**REGULATION**

1. Citation.
2. Definitions.
3. Application.
4. Local Passenger Ship Safety Certificate Survey.
5. Local Passenger Ship to be surveyed.
6. Lifejackets for persons weighing less than thirty-two kilograms.
7. Certificates of Crew.
8. Insurance.
9. Issue of Safety Certificates.
10. Validity of Safety Certificate.
11. Log Book.
12. Count of passengers and crew.
13. Penalties.

**FIRST SCHEDULE.  
SECOND SCHEDULE.  
THIRD SCHEDULE.**

51/1991.

**SHIPPING (LOCAL PASSENGER SHIP) (SAFETY)  
REGULATIONS***made under section 276*

Citation. **1.** These Regulations may be cited as the Shipping (Local Passenger Ship) (Safety) Regulations.

Definitions. **2.** In these Regulations—  
 “Act” means the Shipping Act;  
 “crew” in relation to a ship includes the Master and seamen;  
 “Director” means the Director of Maritime Services;  
 “local passenger ship” means a ship carrying more than twelve passengers operating solely within the waters of Trinidad and Tobago;  
 “surveyor” means a person appointed as such under section 231 of the Act.

Application. **3.** These Regulations apply to Trinidad and Tobago registered local passenger ships of between twenty-four and fifty metres in length, which convey passengers for payment in money or in kind.

Local Passenger Ship Safety Certificate Survey. **4.** A Local Passenger Ship Safety Certificate shall be issued in accordance with these Regulations for a period of not more than twelve months and may be subject to any limitations endorsed thereon.

Local Passenger Ship to be surveyed. **5.** (1) Every local passenger ship shall be surveyed once every twelve months by a surveyor who shall furnish the Director with a declaration containing statements of the following particulars:  
 (a) the stability of the ship;  
 (b) the nature of the prescribed safety equipment of the ship;  
 (c) the condition of the hull, machinery and prescribed safety equipment of the ship;  
 (d) the limits, if any, beyond which, as regards the hull, machinery and safety equipment, the ship is not fit to ply;

- (e) the crew required for the safe navigation of the ship and the safety of the passengers carried therein; and
  - (f) the number of persons the ship is, in his judgment, capable of carrying with safety.
- (2) The surveyor shall, when carrying out the survey of a local passenger ship, take into account, *inter alia*, the following:
- (a) the age, construction, general condition and configuration of the ship;
  - (b) the machinery;
  - (c) the deck space and seating capacity;
  - (d) that there should be carried on board—
    - (i) for each person the ship is certified to carry, a lifejacket suitable for a person weighing thirty-two kilograms or more; and
    - (ii) for ten per cent of the total number of persons the ship is certified to carry an equal number of lifejackets each suitable for a person weighing less than thirty-two kilograms;
  - (e) that lifeboats, liferafts, buoyant apparatus or lifebuoys are to be provided, sufficient for the total number of persons the ship is certified to carry;
  - (f) that where the ship is used for pleasure cruises an emergency rescue boat, fitted with an engine, is to be carried where the configuration and manoeuvring characteristics of the ship do not facilitate the rescue of a person directly from the water;
  - (g) that the ship should, where appropriate, be equipped with at least—
    - (i) a suitable fire extinguisher in each compartment;
    - (ii) a fire pump, hoses and nozzles, so that a jet of water can be brought to bear on any part of the ship; and

LAWS OF TRINIDAD AND TOBAGO

MINISTRY OF THE ATTORNEY GENERAL AND LEGAL AFFAIRS

www.legalaffairs.gov.tt

416

Chap. 50:10

Shipping

[Subsidiary]

Shipping (Local Passenger Ship) (Safety) Regulations

- (iii) a fire axe,  
so that where the pump specified in subparagraph (ii) is driven by the main engine a portable diesel driven pump is also to be carried;
- (h) that the ship should comply with the Shipping (Distress Signals and Prevention of Collisions) Regulations;
- (i) that the ship is to be fitted with a search light and a marine radiotelephone installation;
- (j) that distress signalling equipment and a first aid kit are carried;
- (k) that the steering arrangements, mooring equipment and ground tackle are adequate.

Lifejackets for persons weighing less than thirty-two kilograms.

6. Where, on a particular voyage, the number of persons weighing less than thirty-two kilograms exceeds ten per cent of the total number of persons on the local passenger ship, there should be carried on board for each such person a suitable lifejacket.

Certificates of Crew.

7. Every master, mate and engineer shall hold a Motor Launch Certificate or such higher certificate of competency as may be determined by the Director.

Insurance.

8. Every local passenger ship shall be insured in respect of any liability which may be incurred in respect of third-party risks caused by, or arising out of the use of, the ship.

Issue of Safety Certificates.

9. Where the Director is satisfied that each of the particulars listed in the surveyor's declaration referred to in regulation 5 is adequate and where he is satisfied that the local passenger ship is insured in accordance with regulation 8, on payment of the fee prescribed in the First Schedule he shall issue a Local Passenger Ship Safety Certificate (hereinafter referred to as "a Safety Certificate") in the form prescribed in the Second Schedule.

First Schedule.

Second Schedule.

Validity of Safety Certificate.

10. A Safety Certificate is not valid where—

- (a) the equipment specified in the certificate is not carried or is not in working condition;

UNOFFICIAL VERSION

UPDATED TO 31ST DECEMBER 2016

- (b) the crew do not hold at least the level of certification required on the certificate;
- (c) the number of crew required by the certificate is not carried;
- (d) the local passenger ship carries more than the number of persons it is certified to carry;
- (e) the local passenger ship does not have the insurance cover required by regulation 8;
- (f) the period for which the certificate was issued has expired.

**11.** A log book is to be kept on Board every local passenger ship and in it shall be recorded the entries referred to in the Third Schedule.

Log Book.

Third  
Schedule.

**12.** An accurate count of the number of persons on board a local passenger ship shall be made before the commencement of each voyage and this record must be entered in the ship's log book and also left with a responsible person ashore.

Count of  
passengers and  
crew.

**13.** (1) Where a local passenger ship proceeds on any voyage or excursion without a valid Safety Certificate, the owner and master of the ship are each guilty of an offence and liable to a fine of one thousand dollars and to imprisonment for six months.

Penalties.

(2) Where a local passenger ship proceeds on any voyage or excursion without compliance with regulation 12, the master of the ship is guilty of an offence and liable to a fine of one thousand dollars.

**LAWS OF TRINIDAD AND TOBAGO**

MINISTRY OF THE ATTORNEY GENERAL AND LEGAL AFFAIRS

www.legalaffairs.gov.tt

418

**Chap. 50:10**

*Shipping*

[Subsidiary]

*Shipping (Local Passenger Ship) (Safety) Regulations*

Regulation 9.

**FIRST SCHEDULE**

**FEEES**

<i>Service</i>	<i>Fees</i>
1. For the issue of a Safety Certificate ... ..	\$500.00
2. For the replacement of a Safety Certificate which has been lost or destroyed ... ..	\$100.00

Regulation 9.

**SECOND SCHEDULE**

REPUBLIC OF TRINIDAD AND TOBAGO

**LOCAL PASSENGER SHIP SAFETY CERTIFICATE**

ISSUED UNDER THE SHIPPING (LOCAL PASSENGER SHIP) (SAFETY) REGULATIONS, 1991

*made under section 276 of the Shipping Act, Chap. 50:10*

<i>Name of Ship</i>	<i>Distinctive Number or Letters</i>	<i>Port of Registry</i>	<i>Gross Tonnage</i>
---------------------	--	-------------------------	----------------------

1. The above-mentioned ship has been duly surveyed in accordance with the provisions of the Regulations referred to above.
2. The survey showed that—
  - (a) the stability of the ship is adequate; and
  - (b) the hull machinery and prescribed safety equipment are in good condition.
3. The ship is authorised to operate within the following area:
 

.....

.....
4. The ship is certified to carry a total of no more than ..... persons.

UNOFFICIAL VERSION

UPDATED TO 31ST DECEMBER 2016

5. The following life saving appliances are carried on board:
- life boats capable of accommodating ..... persons.
  - liferafts capable of accommodating ..... persons.
  - buoyant apparatus capable of accommodating ..... persons.
  - lifebuoys capable of accommodating ..... persons.
  - lifejackets suitable for persons weighing thirty-two kilograms or more.
  - lifejackets suitable for persons weighing less than thirty-two kilograms.
6. The following fire-fighting appliances are carried on board:
- Fire extinguishers
  - Fire Pumps
  - Fire Hoses and Nozzles
  - Fire Axes.
7. The ship is fitted with a marine radiotelephone installation, search light, first-aid kit and is provided with navigation lights and means of making sound signals and distress signals in accordance with the provisions of the Shipping (Distress Signals and Prevention of Collisions) Regulations.
8. The minimum crew is to comprise the following persons holding the qualifications stated:
- Master .....
  - Mate .....
  - Engineer .....
  - ..... Seamen

This certificate remains in force until .....

*Director of Maritime Services,  
Maritime Services Division*

**LAWS OF TRINIDAD AND TOBAGO**

MINISTRY OF THE ATTORNEY GENERAL AND LEGAL AFFAIRS

www.legalaffairs.gov.tt

420

**Chap. 50:10**

*Shipping*

**[Subsidiary]**

*Shipping (Local Passenger Ship) (Safety) Regulations*

Regulation 11.

**THIRD SCHEDULE**

**ENTRIES REQUIRED TO BE MADE IN THE LOG BOOK  
BY THE MASTER OF A LOCAL PASSENGER SHIP**

**Particulars of entry**

1. The name of the ship, its port of registry, official number and gross or register tonnage.

2. The name and address of the registered owner or of the registered managing owner or of the ship's husband or manager.

3. The name of the master of the ship and the number of his certificate of competency.

4. The date on and place at which the log book is opened.

5. The date on and place at which the log book is closed.

6. A record of the date and hour of departure for sea from, and arrival from sea at, any dock, wharf, port or harbour.

7. A record of the number of passengers on board and members of the crew.

8. Where any of the following casualties has occurred:

(a) the loss or presumed loss, stranding, grounding, abandonment of or damage to the ship; or

(b) a loss of life caused by fire on board or by any accident to the ship or a ship's boat, or by any accident occurring on board the ship or a ship's boat; or

(c) any damage caused by the ship,

a description of the casualty and the place where, or the position of the ship when, it occurred.

9. A record of every signal of distress or a message that a vessel, aircraft or person is in distress at sea, that was observed or received.

---

UNOFFICIAL VERSION

UPDATED TO 31ST DECEMBER 2016

**SHIPPING (MEDICAL EXAMINATION) REGULATIONS**

ARRANGEMENT OF REGULATIONS

**REGULATION**

1. Citation.
2. Definitions.
3. Application.
4. Prohibition on employment.
5. Issue of medical fitness certificate.
- 5A. Medical examination.
- 5B. Approved medical practitioner may consult.
6. Certificates equivalent to medical fitness certificates.
7. Certificates issued by foreign States.
8. Period of validity of certificate.
9. Suspension or cancellation of valid certificate.
- 9A. Seafarer with certificate to be examined in case of illness.
10. Right of appeal.
11. Records and annual returns.
12. Inspection and detention of a Trinidad and Tobago ship.
13. Inspection, detention and other measures in respect of foreign ships.
14. Liability for costs and compensation.
15. Penalties.

**FIRST SCHEDULE.**

**SECOND SCHEDULE.**

**THIRD SCHEDULE.**

**FOURTH SCHEDULE.**

**FIFTH SCHEDULE.**

[Subsidiary]

2/1991.  
[80/2002].**SHIPPING (MEDICAL EXAMINATION) REGULATIONS***made under section 146*

Citation.

1. (1) These Regulations may be cited as the Shipping (Medical Examination) Regulations.

(2) These Regulations come into operation on the 1st January, 1991.

Definitions.

2. In these Regulations—

“approved” means approved for the purpose by the Minister;

“approved medical practitioner” for the purposes of these Regulations means a medical practitioner approved by the Minister to whom the responsibility for health is assigned;

“chemical” means any substance listed in either or both of the following publications of the International Maritime Organisation:

(a) Chapter VI of the 1986 edition of the Code for the Construction of Equipment of Ships Carrying Dangerous Chemicals in Bulk (the BCH Code); and

(b) Chapter 17 of the 1986 edition of the International Code for the Construction and Equipment of Ships Carrying Dangerous Goods in Bulk (the IBC Code),

and any reference to these publications includes references to any subsequent supplements or publications amending or replacing them, which may be published from time to time by the Organisation and which are considered by the Minister to be relevant;

“fishing vessel” means a vessel used or intended to be used for commercial fishing;

“gross tonnage” in relation to a ship means its gross tonnage as determined in accordance with the Shipping (Tonnage) Regulations, and where a ship is assigned alternative gross tonnages it shall be taken to be the larger of those tonnages;

“medical fitness certificate” means a certificate issued under regulation 5, whether or not subject to restrictions, or a certificate deemed to be equivalent thereto under regulation 6 or 7;

“Minister” means, unless otherwise specified within the Regulations, the Minister to whom the responsibility for shipping is assigned;

“pleasure craft” means a ship, however propelled, that is used exclusively for pleasure and does not carry passengers for hire or reward, but does not include a ship that is provided for the transport or entertainment of lodgers at any institution, hotel, boarding house, guest house or other establishment;

“restricted service” means that the employment of a seafarer is restricted to certain shipping trades, geographical areas and types of ship or job, for such period of time as may be stipulated by an approved medical practitioner;

“seafarer” includes a master and a seaman;

“Trinidad and Tobago Ship” has the same meaning as in section 2 of the Shipping Act.

**3.** (1) These Regulations apply to Trinidad and Tobago ships. *Application.*

(2) Regulations 13 and 14 apply to ships other than Trinidad and Tobago ships when they are in a port or the territorial waters of Trinidad and Tobago.

(3) These Regulations apply to ships which are of two hundred gross tons or over and which proceed to sea and are actively engaged in commercial trading but excluding fishing vessels, pleasure craft and ships trading exclusively in the Gulf of Paria.

**4.** (1) Subject to this regulation, no person shall employ a seafarer in a ship to which these Regulations apply unless that seafarer is the holder of a valid medical fitness certificate. *Prohibition on employment.*

(2) A seafarer who has served at sea at any time during the two years immediately preceding the date on which these Regulations come into operation may continue his seagoing employment without a medical fitness certificate referred to in subregulation (1) for a period of one year from that date.

(3) A seafarer, the validity of whose certificate expires while he is in a location where medical examination in accordance with the Regulations is impracticable, may continue to be employed without a medical certificate referred to in subregulation (1) for a period not exceeding three months from the date of expiry of the medical fitness certificate.

(4) Subject to this Regulation, no person shall employ a seafarer in a ship in a capacity or in a geographical area precluded by any restriction in that seafarer's medical fitness certificate.

(5) Subject to this Regulation, no person shall employ a seafarer in a ship carrying chemicals in bulk unless that seafarer is the holder of a valid medical fitness certificate issued in respect of a medical examination undertaken not more than twelve months previously, notwithstanding that the period of validity specified in the medical fitness certificate may exceed twelve months.

(6) This Regulation does not apply to the employment of—

- (a) a pilot who is not a member of the crew;
- (b) a person employed in a ship solely in connection with the construction, alteration, repair or testing of the ship, its machinery or equipment, and not engaged in the navigation of the ship;
- (c) a person solely employed in work directly related to—
  - (i) the exploration of the seabed or subsoil or the exploitation of their natural resources;
  - (ii) the storage of gas in or under the seabed or the recovery of gas so stored;
  - (iii) the laying, inspection, testing, repair, alteration, renewal or removal of any submarine telegraph cable; or
  - (iv) submarine pipeline works, including the assembling, inspection, testing, maintaining, adjusting, repairing, altering, renewing, changing the position of, or dismantling a pipeline or length of pipeline;and who is not engaged in the navigation of the ship or is not engaged in the deck, engine room, radio, medical or catering department of that ship;
- (d) a member of the Defence Force when acting as such a member;
- (e) a person employed in a port who is not ordinarily employed at sea; or

- (f) a person employed in a ship solely to provide goods, personal services or entertainment on board and who is not employed by the owner or the person employing the master of the ship and who has no emergency safety responsibilities.

**5.** (1) An applicant for a medical fitness certificate shall be examined by an approved medical practitioner.

Issue of medical fitness certificate. [80/2002].

(2) An approved medical practitioner who examines an applicant and determines that the applicant is fit, having regard to the medical and visual standards in the First Schedule, shall issue to the applicant, a medical fitness certificate on the form set out in the Second Schedule.

First Schedule.

Second Schedule.

(3) An approved medical practitioner who examines an applicant and determines that—

- (a) although the applicant is fit, restrictions should be imposed on his service at sea; or  
(b) the applicant is not fit having regard to medical and visual standards,

shall give to the applicant, notice of the restrictions or unfitness on the form set out in the Third Schedule.

Third Schedule.

**5A.** (1) A seafarer who—

Medical examination. [80/2002].

- (a) has not attained eighteen years of age, shall have an annual medical examination;  
(b) has attained eighteen years of age, shall have a medical examination at intervals not exceeding two years; and  
(c) serves on a bulk chemical carrier, shall have a medical examination, which may include blood tests, annually or at more frequent intervals, according to the nature of the cargo.

(2) A seafarer shall produce a form of personal identification to an approved medical practitioner before having a medical examination.

LAWS OF TRINIDAD AND TOBAGO

MINISTRY OF THE ATTORNEY GENERAL AND LEGAL AFFAIRS

www.legalaffairs.gov.tt

426

Chap. 50:10

Shipping

[Subsidiary]

Shipping (Medical Examination) Regulations

(3) A seafarer who has previously been issued with a medical fitness certificate—

- (a) by another approved medical practitioner;
- (b) after an appeal to a medical referee; or
- (c) indicating that he has failed a medical examination,

shall so inform the approved medical practitioner before having a medical examination.

Approved medical practitioner may consult. [80/2002].

**5B.** (1) An approved medical practitioner may, with the written consent of a seafarer, consult with the seafarer's medical practitioner.

(2) Where an approved medical practitioner finds it necessary to consult with other medical practitioners, the medical ethical standards shall apply, but the approved medical practitioner alone, shall decide the question of the fitness of a seafarer, in accordance with the medical and visual standards, subject to the right of appeal under regulation 10.

Certificates equivalent to medical fitness certificates.

**6.** (1) A certificate of medical and visual fitness for seafaring employment issued by a medical practitioner to a seafarer in respect of a medical examination conducted before the date on which these Regulations come into operation shall be deemed for the purposes of these Regulations to be equivalent to a medical fitness certificate issued under these Regulations.

(2) A certificate referred to in subregulation (1) shall remain valid from the date of the medical examination only for the appropriate maximum period prescribed in regulation 8 or for such lesser period as may be specified in the certificate.

Certificates issued by foreign States.

**7.** (1) Any medical fitness certificate issued to a seafarer in accordance with the provisions of the Medical Examination (Seafarers) Convention 1946 (International Labour Organisation Convention 73 of 1946) or the Merchant Shipping (Minimum Standards) Convention 1976 (International Labour Organisation Convention 147 of 1976)—

- (a) by an authority empowered in that behalf by the laws of a country outside Trinidad and Tobago which has ratified the Convention of 1946 or the Convention of 1976; or

UNOFFICIAL VERSION

UPDATED TO 31ST DECEMBER 2016

- (b) by an approved authority empowered in that behalf by the laws of a foreign State,

shall be deemed for the purposes of these Regulations to be equivalent to a medical fitness certificate issued under these Regulations.

(2) A certificate referred to in subregulation (1) shall remain in force, unless renewed, only until the expiration of the period of validity specified in that certificate in the case of foreign ships, and for the appropriate maximum period (according to the age of the seafarer) prescribed in regulation 8 or for such lesser period as may be prescribed in the certificate in the case of Trinidad and Tobago ships.

**8.** (1) Subject to subregulation (2), an approved medical practitioner who issues a medical fitness certificate under regulation 5, shall specify on the certificate, the period of validity of the certificate.

Period of validity of certificate. [80/2002].

(2) The period of validity of the certificate shall be from the date of the medical examination and shall not exceed—

- (a) in the case of a seafarer who has not attained eighteen years of age, one year; and  
(b) in the case of a seafarer who has attained eighteen years of age, two years.

**9.** Where an approved medical practitioner has reasonable grounds for believing that there has been a significant change in the medical fitness of a seafarer during the period of validity of his medical fitness certificate, the practitioner shall, using the form prescribed in the Third Schedule, notify the seafarer concerned and may—

Suspension or cancellation of valid certificate. [80/2002].

Third Schedule.

- (a) suspend the validity of that certificate until the seafarer has undergone a further medical examination;  
(b) suspend the certificate for such period as he considers that the seafarer is likely to remain permanently unfit to go to sea; or  
(c) cancel the certificate if he considers that the seafarer is likely to remain permanently unfit to go to sea.

LAWS OF TRINIDAD AND TOBAGO

MINISTRY OF THE ATTORNEY GENERAL AND LEGAL AFFAIRS

www.legalaffairs.gov.tt

428

Chap. 50:10

Shipping

[Subsidiary]

Shipping (Medical Examination) Regulations

Seafarer with certificate to be examined in case of illness. [80/2002].

**9A.** (1) A seafarer who holds a valid medical fitness certificate and suffers a condition set out in the First Schedule, shall be examined by an approved medical practitioner as soon as practicable after diagnosis.

(2) An approved medical practitioner who examines a seafarer under subregulation (1), shall revise the medical fitness certificate of the seafarer;

Right of appeal. [80/2002].

**10.** (1) A seafarer who is aggrieved by—

- (a) a medical practitioner's refusal to issue him with a medical fitness certificate;
- (b) any restriction imposed on such a certificate; or
- (c) the suspension for a period of more than three months or cancellation of that certificate by an approved medical practitioner pursuant to regulation 9,

may apply to the Minister for the matter to be reviewed.

(2) The Minister shall immediately refer the matter to the Chief Medical Officer through the Minister to whom the responsibility for health is assigned, for review by a medical referee.

(3) The medical referees referred to in subregulation (2) shall be selected by the Chief Medical Officer from a list of referees kept by him for the purposes of these Regulations.

(4) An application under subregulation (1) may be made only by—

- (a) a seafarer who has served at any time during the two years immediately preceding the date on which these Regulations come into operation; or
- (b) a seafarer who has held a valid medical fitness certificate at any time during the two years immediately preceding that refusal, imposition of a restriction, suspension or cancellation.

(5) An application under subregulation (1)—

- (a) shall be lodged with the Minister within one month of the date on which the seafarer is given notice of the refusal, imposition of a restriction,

UNOFFICIAL VERSION

UPDATED TO 31ST DECEMBER 2016

suspension or cancellation, or such longer period as the Minister may determine if delay is caused by the seafarer's employment on board ship away from Trinidad and Tobago; and

- (b) shall specify the name and address of the medical practitioner responsible for the refusal, imposition of a restriction, suspension or cancellation and shall include the consent of the seafarer for that practitioner to provide a report to the Chief Medical Officer and to the medical referee.

(6) The Chief Medical Officer shall obtain a report from the approved medical practitioner by whom the applicant was examined and shall forward it to the medical referee who shall examine the medical condition of the applicant.

(7) The medical referee shall, if the applicant so requests, disclose to the applicant the report of the approved medical practitioner and any other evidence not produced by the applicant himself except that if the medical referee considers that such disclosure would be harmful to the applicant's health the referee shall not be required to make such disclosure.

(8) The medical referee shall have regard to any relevant medical evidence, whether produced by the applicant, his employer, the Maritime Services Division or by any other means, whether or not disclosed under subregulation (7), and shall—

- (a) determine whether the diagnosis has been established in accordance with the medical evidence on which the approved medical practitioner reached his decision and generally, with the assistance of a report from a consultant in the appropriate specialty;
- (b) determine whether the medical and visual standards have been properly interpreted;
- (c) consider whether a seafarer previously declared permanently unfit, may return to sea; and
- (d) where a case is not covered by the medical and visual standards or in cases of category E where

exceptional medical considerations apply, decide an appropriate classification, after consultation with the approved medical practitioner and consideration of the evidence;

(9) In the light of the medical evidence before him, the medical referee shall, if he considers that the applicant is fit, having regard to the medical standard referred to in regulation 5, issue the applicant with a medical fitness certificate in the approved form.

(10) Where the medical referee considers that restrictions as to capacity or geographical area other than those imposed on the medical fitness certificate issued to the applicant should be imposed, or that any restrictions so imposed should be deleted or varied, he shall issue to the applicant a revised medical fitness certificate and the former certificate shall thereupon cease to have effect and in any other case he shall notify the applicant of his decision but any such action by the medical referee shall be taken not later than two months from the date on which the application for review is lodged with the Minister, which date shall be notified to the medical referee by the Chief Medical Officer, or within such longer period as the Minister may determine.

Records and  
annual returns.  
[80/2002].

Fourth  
Schedule.

Fifth  
Schedule.

**11.** Any approved medical practitioner who conducts a medical examination in accordance with these Regulations shall—

- (a) keep full clinical notes and make a record of the medical examination on the form set out in the Fourth Schedule and shall retain the notes and the record for a period of six years from the date of the examination; and
- (b) send to the Director of Maritime Services an annual return of all such examinations in the form set out in the Fifth Schedule, which form, so far as the Minister considers practicable, shall not include medical information which can be identified as applying to a particular person.

**12.** (1) A person duly authorised by the Minister may inspect any Trinidad and Tobago ship to which these Regulations apply.

Inspection and detention of a Trinidad and Tobago ship.

(2) Where a person mentioned in subregulation (1) is satisfied that a seafarer, whose employer is required by regulation 4 to ensure that he is the holder of a medical fitness certificate—

- (a) is unable to produce a certificate which meets the requirements of that Regulation; and
- (b) is in such a state of ill health that the ship could not sail without serious risk to the safety and health of those on board,

he may detain the ship, but shall not, in the exercise of those powers, detain or delay the ship unreasonably.

**13.** (1) Any person duly authorised by the Minister may inspect any ship to which these Regulations apply, other than a Trinidad and Tobago ship when the ship is in a Trinidad and Tobago port or in the territorial waters of Trinidad and Tobago, and if he is satisfied that any seafarer is unable to produce a valid medical fitness certificate he may—

Inspection, detention and other measures in respect of foreign ships.

- (a) send a report to the government of the country in which the ship is registered, and a copy thereof to the Director-General of the International Labour Office; and
- (b) where conditions on board are clearly hazardous to safety or health, and where the ship has called at a Trinidad and Tobago port in the normal course of business or for operational reasons—
  - (i) take such measures as are necessary to rectify those conditions; or
  - (ii) detain the ship.

(2) Where the person authorised under subregulation (1) takes either of the measures specified in subregulation (1)(b), he shall forthwith notify the nearest maritime, consular or diplomatic representative of the flag State of the ship.

(3) The person authorised under subregulation (1) shall not, in the exercise of his powers under this Regulation, detain or delay the ship unreasonably.

Liability for costs and compensation.

**14.** (1) Where a ship is detained under regulation 12 or 13 and there was, at the time of detention, reasonable and probable cause by reason of the state of health of one or more members of the crew giving rise to—

- (a) serious risk to the safety and health of those on board; or
- (b) any member of the crew being unable to perform the duties required of him due to being medically unfit to the extent that the ship is, in effect, undermanned,

the owner of the ship is liable to pay to the Minister any costs of and incidental to the detention of the ship and those costs are, without prejudice to any other remedy, recoverable in the same manner as salvage.

(2) Where it is proved that there was no reasonable and probable cause for the detention of the ship under regulation 12 or 13 the Minister is liable to pay to the owner of the ship—

- (a) the owner's costs of and incidental to the detention; and
- (b) compensation for any loss or damage sustained by the owner by reason of the detention.

Penalties.

**15.** (1) Unless otherwise provided in the Act any person who contravenes regulation 4 is guilty of an offence and liable on summary conviction to a fine not exceeding one thousand dollars for each contravention.

(2) In any proceedings for an offence under these Regulations it shall be a defence for the employer to show that all reasonable steps had been taken by him to ensure compliance with the Regulations.

**FIRST SCHEDULE**

Regulation 5(2).  
[80/2002].

**MEDICAL AND VISUAL STANDARDS**

**PART A**

*General*

1. (1) An approved medical practitioner shall, when examining a seafarer— General principles.

- (a) interpret the medical and visual standards widely; and
- (b) have regard to the occupational circumstances which apply at sea and in particular—
  - (i) the potentially hazardous nature of seafaring, which requires a high standard of health and continuing fitness;
  - (ii) that medical facilities on board a ship may be inadequate, as few ships carry medical practitioners and medical supplies are limited;
  - (iii) that there may be a delay before full medical treatment is available;
  - (iv) the possible difficulty of providing or replacing required medication;
  - (v) the confined nature of life on board a ship and the ability of a seafarer to live and work in a closed community;
  - (vi) that the illness of a seafarer may place a burden on others or impair the safe and efficient working of a ship especially where there is a limited crew complement; and
  - (vii) the potential need for seafarers to participate in an emergency drill, which may involve strenuous activity in adverse conditions.

(2) An approved medical practitioner, before issuing a medical fitness certificate, shall be satisfied that the seafarer—

- (a) does not suffer from a disease, defect or condition which may be aggravated by working at sea or represent an unacceptable risk to the health of the seafarer, other seafarers or the safety of the ship; and
- (b) is not pursuing a course of treatment which may cause adverse side effects at sea.

LAWS OF TRINIDAD AND TOBAGO

MINISTRY OF THE ATTORNEY GENERAL AND LEGAL AFFAIRS

www.legalaffairs.gov.tt

434

Chap. 50:10

Shipping

[Subsidiary]

Shipping (Medical Examination) Regulations

(3) A seafarer shall not be allowed to serve at sea where he suffers from a condition which—

- (a) precludes air travel, including pneumothorax and a condition which predisposes to barotrauma; or
- (b) carries the possibility of serious exacerbation requiring expert treatment.

(4) Where medication is acceptable for a seafarer, the seafarer shall, with the agreement of the master, arrange for a reserve stock of the prescribed medication to be held in a safe place.

(5) As a general rule, a seafarer shall not be allowed to serve at sea where the loss of medicine may precipitate the rapid deterioration of a condition.

Classification in accordance with medical and visual standards.

2. (1) Where a seafarer satisfies the medical and visual standards, the approved medical practitioner may assess the seafarer as fit and shall classify him as—

- (a) category A for unrestricted service at sea;
- (b) category A(T) where the seafarer is considered fit for all shipping trades, geographical areas, types of ship or job but medical surveillance is required at intervals; and
- (c) category B for restricted service at sea.

(2) Where a seafarer does not satisfy the medical and visual standards, the approved medical practitioner shall assess the seafarer as not fit and classify him as—

- (a) category C for a temporary restriction from service at sea;
- (b) category D for an indefinite restriction from service at sea; and
- (c) category E for permanent restriction from service at sea.

(3) Where a seafarer is classified as category A(T), the approved medical practitioner shall validate the medical fitness certificate only for the appropriate period which shall take into account the expected duration of the tour of duty.

(4) Where a seafarer is classified as—

- (a) category C, his application may be reviewed after two weeks; and
- (b) category D, his application may be reviewed after one month.

(5) The employer of a seafarer, or the person authorised by the employer to act on his behalf, shall ensure that the category recommended by the approved medical practitioner is taken fully into account when the engagement or the continued employment of a seafarer is under consideration.

UNOFFICIAL VERSION

UPDATED TO 31ST DECEMBER 2016

3. (1) Where a seafarer has been classified as category B, the approved medical practitioner shall clearly state on the medical fitness certificate, the type of restriction and the period of time during which it shall be operative. Restricted service.

(2) Where a seafarer has been assessed as fit but requires medical treatment or surveillance at frequent intervals, the approved medical practitioner may classify the seafarer as category B and recommend that his service be restricted to ferry and coastal work.

4. (1) An approved medical practitioner shall, where possible, make full use of categories B, C and D before classifying a serving seafarer as category E. Permanent unfitness.

(2) An approved medical practitioner may classify a serving seafarer as category E only after a full investigation has been made and due consideration has been given to the case.

(3) Where the seafarer has been classified as category E, the approved medical practitioner shall, at the request of the seafarer, inform the seafarer's medical practitioner of the decision and the reasons for it.

## PART B

### *Medical Standards*

5. A seafarer who suffers from a gastrointestinal infection shall be classified as category C until satisfactorily treated and in respect of catering staff, shall be examined periodically for one year. Gastrointestinal infections.

6. A seafarer who suffers from a communicable disease, other than a gastrointestinal infection, shall be classified as category C until satisfactorily treated. Other communicable diseases.

7. In a case of active pulmonary tuberculosis— Active pulmonary tuberculosis.
- (a) an approved medical practitioner who—
    - (i) examines a seafarer who has had active pulmonary tuberculosis; and
    - (ii) is satisfied, on the advice of a chest physician, that the lesion is fully healed and that the seafarer has completed a full course of chemotherapy,shall consider the suitability of the seafarer for re-entry into sea service;
  - (b) a seafarer referred to in subclause (a) shall be classified as category A(T) initially, to allow for medical surveillance;

LAWS OF TRINIDAD AND TOBAGO

MINISTRY OF THE ATTORNEY GENERAL AND LEGAL AFFAIRS

www.legalaffairs.gov.tt

436

Chap. 50:10

Shipping

[Subsidiary]

Shipping (Medical Examination) Regulations

- (c) a seafarer who has had one or both of his lungs seriously affected shall not, generally, be considered suitable for re-entry into sea service; and
- (d) a seafarer who has had a relapse shall be classified as category E.

Sexually transmitted diseases.

8. In a case of sexually transmitted disease, a seafarer who—
- (a) is acutely infected shall be classified as category C;
  - (b) is infected and undergoing treatment shall be classified as category C;
  - (c) is under medical surveillance after undergoing treatment shall generally be regarded as fit for unrestricted service unless facilities for surveillance are inadequate, in which case, restricted service may be imposed; and
  - (d) receives treatment shall produce evidence of a satisfactory test of cure.

Human immune virus.

9. (1) A seafarer who is infected with the Human Immune Virus (HIV), shall be classified as category A(T).
- (2) A seafarer who has confirmed Acquired Immune Deficiency Syndrome shall be classified as category E.

Malignant neoplasms.

10. In a case of a malignant neoplasm including lymphoma, leukaemia and similar conditions—
- (a) a seafarer who is diagnosed as having a malignant neoplasm shall be classified as category D;
  - (b) a seafarer referred to in paragraph (a) may be classified as category A, A(T), B or C on the assessment of progress, prognosis, measure of disability and the need for medical supervision following treatment; and
  - (c) except in a case of basal cell skin cancer, no seafarer shall, within five years of completion of treatment, be classified as category A.

Endocrine and metabolic diseases.

11. In a case of an endocrine or a metabolic disease, a serving seafarer who suffers from—
- (a) thyroid disease, shall be classified as category C for investigation and subsequently category A, A(T), B or C on assessment;

UNOFFICIAL VERSION

UPDATED TO 31ST DECEMBER 2016

- (b) an endocrine disease other than thyroid disease, shall be classified as category C for investigation upon which assessment will depend;
- (c) diabetes mellitus, and—
  - (i) requires insulin, shall be classified as category E;
  - (ii) whose diabetes is controlled by food restriction, shall be classified as category D and allowed an initial period of six months to achieve stabilisation;
  - (iii) is mentioned in subparagraph (ii) shall, after the initial period of six months, be subject to medical review at appropriate intervals and the current treatment regimen shall be confirmed with the seafarer's medical practitioner at each review;
  - (iv) who requires oral hypoglycaemic agents shall be classified as category D and allowed an initial period of six months to achieve stabilisation;
  - (v) is mentioned in subparagraph (iv) may, in the absence of any complications, be considered for sea service subject to a medical review and assessment for suitable sea service, every six months; and
  - (vi) a seafarer who has undergone assessment under subparagraph (iii) and (v) shall be classified as category A(T); and
- (d) obesity—
  - (i) which affects his tolerance for exercise, mobility and general health, shall be classified as category C for treatment;
  - (ii) which is refractory or relapsing shall be classified as category E; and
  - (iii) whose body mass index is thirty or more, shall have other existing risk factors for mobility and mortality taken into account before a classification is determined.

12. In a case of a disease of the blood or a blood forming organ, a seafarer who suffers from—

Diseases of the blood or blood forming organs.

- (a) a disease of the haemopoetic system, shall not be allowed sea service; and

LAWS OF TRINIDAD AND TOBAGO

MINISTRY OF THE ATTORNEY GENERAL AND LEGAL AFFAIRS

www.legalaffairs.gov.tt

438

Chap. 50:10

Shipping

[Subsidiary]

Shipping (Medical Examination) Regulations

- (b) unexplained or symptomatic anaemia, shall be classified as category C and subsequently as category A, A(T), B or E on assessment.

Mental disorders.

13. In a case of mental disorder, a seafarer who—

- (a) suffers from acute psychosis whether organic, schizophrenic, manic depressive or any other psychosis listed in the International Classification of Diseases, shall be classified as category E;
- (b) suffers from persistent abuse of alcohol that affects his health by causing physical or behavioural disorder shall be classified as category E;
- (c) has a history of abuse of drugs or substances within the last five years, shall be classified as category E;
- (d) is dependent on a dangerous drug shall be classified as category E; and
- (e) suffers from psychoneurosis including anxiety state, depression or any other mental disorder likely to impair safe performance at sea, shall be classified as category C for assessment and where the psychoneurosis is chronic or recurrent, as category E.

Diseases of the nervous system or sensory organs.

14. In a case of a disease of the nervous system or a sensory organ, a seafarer who—

- (a) suffers from organic nervous disease and in particular, a seafarer who has a condition causing defect of muscular power, balance, mobility and co-ordination, shall be classified as category E, while a seafarer who suffers from a minor localised disorder not causing symptoms of incapacity and unlikely to progress, may be classified as category A;
- (b) has suffered from any type of epilepsy since the age of five years shall be classified as category E;
- (c) is a serving seafarer and suffers a single seizure shall be classified as category C for investigation and then, providing that the post medical history is clear and investigation has shown no abnormality, re-entry into sea service may be considered after one year without a seizure without treatment, or after one year without a seizure following the cessation of treatment;

UNOFFICIAL VERSION

UPDATED TO 31ST DECEMBER 2016

- (d) who is a serving seafarer and has had cranial surgery or significant traumatic brain damage shall be classified as category D for twelve months and subsequently as category A, B or E on assessment;
- (e) suffers from slight infrequent attacks of migraine and who responds quickly to treatment shall be classified as category A, while a seafafer who suffers from frequent attacks of migraine causing incapacity shall be classified as category E;
- (f) has had a single attack of syncope or other disturbance of consciousness shall be classified as category C for assessment, while a seafarer who suffers from recurrent attacks with complete or partial loss of consciousness shall be classified as category E; and
- (g) suffers from Meniere's disease shall be classified as category E.

15. (1) The cardiovascular system of a seafarer shall generally be free from acute or chronic disease causing significant disability. Cardiovascular system.

- (2) A seafarer who—
- (a) suffers from a valvular disease causing significant impairment or requiring surgery shall be classified as category E;
  - (b) has a satisfactorily treated patent ductus arteriosus or a satisfactorily treated arterial septal defect may be accepted for sea service;
  - (c) suffers from hypertension shall be classified as category C for investigation;
  - (d) is a serving seafarer and suffers from hypertension and whose blood pressure can be maintained below 170/100 mm by dietary control shall be classified as category A(T) for annual assessment;
  - (e) is a serving seafarer and suffers from hypertension and whose blood pressure can be maintained below 170/100 mm by anti-hypertension therapy without significant side effects shall be classified as category A(T) to allow medical surveillance and to ensure that arrangements have been made for continuation of treatment;

- (f) suffers from hypertension in circumstances other than those specified in paragraphs (d) and (e) shall be classified as category E;
- (g) has a history of coronary thrombosis myocardial infarction shall be classified as category E;
- (h) has a confirmed case of angina shall be classified as category E;
- (i) suffers from a clinically significant abnormality of rate or rhythm or disorder of conduction shall be classified as category E;
- (j) has had any cerebrovascular accident including transient ischaemic attacks shall be classified as category E;
- (k) who suffers from general cerebral arteriosclerosis including dementia and senility shall be classified as category E;
- (l) has a history of intermittent claudication including a case where vascular surgery was required shall be classified as category E;
- (m) has a slight or moderate degree of varicose veins without symptoms, or oedema shall be classified as category A, while a seafarer who has symptoms shall be classified as category C for treatment;
- (n) has had an operation for varicose veins and the disease recurs with symptoms shall be classified as category D for further surgical opinion, but a seafarer who is not suitable for further treatment shall be classified as category E;
- (o) suffers from chronic varicose ulceration shall be classified as category E;
- (p) suffers from chronic varicose ulceration with thin unhealthy scars of healed ulcers or unhealthy skin of varicose eczema shall be classified as category E;
- (q) suffers from recurrent or persistent deep vein thrombosis or thrombophlebitis shall be classified as category E;
- (r) has hemorrhoids that are not prolapsed, bleeding or causing symptoms shall be classified as category A, while other cases shall be classified as category C until satisfactorily treated; and
- (s) has varicocoele without symptoms shall be classified as category A, while a seafarer who has symptoms shall be classified as category D for a surgical opinion.

16. (1) The respiratory system of a seafarer shall generally be free from acute or chronic disease causing significant disability. Respiratory system.

- (2) A seafarer who—
- (a) suffers from acute sinusitis shall be classified as category C until it is resolved;
  - (b) suffers from chronic sinusitis that is causing disability with frequent relapses despite treatment shall be classified as category E;
  - (c) has nasal obstruction, including septal abnormality or polypus shall be classified as category C until satisfactorily treated;
  - (d) has a history of frequent sore throats or unhealthy tonsils with adenitis shall be classified as category C until satisfactorily treated;
  - (e) has a mild uncomplicated case of bronchitis or emphysema and has a good tolerance for exercise may be classified as category A, while a seafarer with recurring chronic bronchitis or emphysema causing significant disability in relation to the job shall be classified as category E;
  - (f) is suspected of having bronchial asthma shall be classified as category C for investigation;
  - (g) has confirmed bronchial asthma shall be classified as category E, unless the seafarer has—
    - (i) a history of bronchial asthma which was resolved without recurrence, before the age of sixteen years, in which case he shall be classified as category A(T); and
    - (ii) well controlled asthma treated with inhaled medication only and without a history of exacerbation requiring hospital admission or oral steroids, in which case he shall be classified as category A(T);
  - (h) suffers from occupational asthma shall be classified as category B to avoid the allergen;
  - (i) suffers from pneumothorax shall be classified as category D for at least twelve months; and
  - (j) suffers from recurrent pneumothorax shall be classified as category E.

LAWS OF TRINIDAD AND TOBAGO

MINISTRY OF THE ATTORNEY GENERAL AND LEGAL AFFAIRS

www.legalaffairs.gov.tt

442

Chap. 50:10

Shipping

[Subsidiary]

Shipping (Medical Examination) Regulations

Diseases of the digestive system.

17. (1) A seafarer shall generally be orally fit.

(2) A seafarer who has an infection of the mouth or gum or a dental defect shall be classified as category C until satisfactorily treated.

(3) In a case of a disease of the oesophagus, stomach and duodenum, a seafarer who—

(a) suffers from peptic ulceration shall be classified as category C for investigation;

(b) has confirmed ulceration shall not be allowed to resume sea service until—

(i) he is free from the symptoms of ulceration;

(ii) there is evidence of healing on gastroscopy; and

(iii) he has been on an ordinary diet, without treatment, for at least three months;

(c) is referred to in paragraph (b), who has been allowed sea service, shall be classified as category A(T);

(d) suffers from gastrointestinal bleeding, perforation or recurrent peptic ulceration, despite maintenance H2 blocker treatment, or an unsatisfactory operation result, shall be classified as category E;

(e) suffers from recurrent attacks of appendicitis shall be classified as category C pending surgical removal;

(f) has non-infective enteritis and colitis that is severely recurrent or requires a special diet shall be classified as category E; and

(g) has intestinal stoma shall be classified as category E.

(4) In a case of a disease of the liver or pancreas, a seafarer who has—

(a) cirrhosis of the liver shall be classified as category C for investigation, but where the condition is serious or progressive or where complications such as oesophageal varices or ascites are present, the seafarer shall be classified as category E;

(b) had a complete surgical cure from biliary tract diseases shall be classified as category A or category A(T) on assessment; and

(c) recurrent pancreatitis or a case in which alcohol is an aetiological factor, shall be classified as category E.

UNOFFICIAL VERSION

UPDATED TO 31ST DECEMBER 2016

18. (1) A seafarer who has—
- (a) proteinuria, glycosuria or other urinary abnormalities shall be referred for investigation;
  - (b) acute nephritis shall be classified as category C until resolved; and
  - (c) subacute, chronic nephritis or nephrosis shall be classified as category C for investigation and subsequently as category B or category E on assessment.
- (2) In a case of the urinary tract, a seafarer who—
- (a) has an acute urinary infection shall be classified as category C until satisfactorily treated, while a recurrent case shall be classified as category B, unless a full investigation has proved satisfactorily;
  - (b) has renal or ureteric calculus shall be classified as category C for investigation and any necessary treatment;
  - (c) suffers an isolated attack of renal colic with passage of small calculus shall be classified as category A after a period of observation, provided that his urine and renal function remain normal and there is no clinical and radiological evidence of other calculi;
  - (d) suffers from recurrent formation of stone shall be classified as category E;
  - (e) suffers from urinary obstruction, from any cause, shall be classified as category D for investigation and where it is irremediable, as category E;
  - (f) is a serving seafarer and has had a kidney removed and the remaining kidney is healthy with normal function, shall be classified as category A(T) and where sea service is in the tropics or under other conditions of high temperature, as category B;
  - (g) has had a renal transplant shall be classified as category E;
  - (h) has incontinence of urine shall be classified as category C for investigation and where it is irremediable, as category E;
  - (i) has an enlarged prostate shall be classified as category C for investigation;
  - (j) suffers from small and symptomless hydrocoele shall be classified as category A;

Diseases of the  
genito-urinary  
system.

LAWS OF TRINIDAD AND TOBAGO

MINISTRY OF THE ATTORNEY GENERAL AND LEGAL AFFAIRS

www.legalaffairs.gov.tt

444

Chap. 50:10

Shipping

[Subsidiary]

Shipping (Medical Examination) Regulations

- (k) suffers from large or recurrent hydrocoele shall be classified as category C, or where untreated, as category E; and
- (l) a seafarer who suffers from abnormality of the primary and secondary sexual characteristics shall be classified as category C for investigation.

Obstetrical and gynaecological conditions.

19. (1) A seafarer who suffers from a gynaecological disorder or disease which may affect her capacity to work shall be classified as category E.

(2) A seafarer's medical practitioner shall discuss with the seafarer the implications of continuing sea service while being pregnant, particularly where it is a first pregnancy.

(3) A seafarer who has a normal pregnancy before the twenty-eighth week may be permitted sea service on a short haul trip or on a long haul trip on a vessel carrying a medical practitioner and the seafarer shall be classified as category B to allow for ante-natal care.

(4) A seafarer who has passed her twenty-eighth week of pregnancy shall not be permitted sea service until at least six weeks after delivery.

(5) A seafarer diagnosed as having an abnormal pregnancy shall be classified as category D.

Skin.

20. (1) A person who has a focus of skin sepsis shall not be employed as a member of a catering staff.

(2) A seafarer whose skin is liable to be aggravated by heat, sea air, oil, caustics, detergents or specific occupational allergens shall be classified as category A(T), B, C, D or E on assessment.

(3) A seafarer who has—

- (a) an infection of the skin shall be classified as category C until satisfactorily treated; and
- (b) acne, shall generally be classified as category A, but a seafarer who has severe pustular cystic acne shall be classified as category E.

(4) In a case of another inflammatory skin condition, a seafarer who has—

- (a) atopic dermatitis and related conditions shall be classified as category C until satisfactorily treated;
- (b) contact dermatitis shall be classified as category C and be referred for a dermatological opinion;
- (c) acute eczema shall be classified as category C and shall not resume sea service until his skin is healthy;

UNOFFICIAL VERSION

UPDATED TO 31ST DECEMBER 2016

- (d) recurrent eczema of more than minimal extent shall be classified as category E; and
- (e) psoriasis shall generally be classified as category A but a widespread or ulcerated case shall be classified as category C for treatment, while a severe case that is resistant to treatment, frequently relapsing or associated with joint disease, shall be classified as category E.

21. (1) A seafarer shall not have a defect of the musculo-skeletal system which may interfere with the discharge of his duties and his muscular power, balance, mobility and co-ordination shall be unimpaired. Musculo-skeletal system.

(2) A seafarer who has a limb prosthesis shall be classified as category E.

(3) A seafarer who suffers from recurrent, incapacitating back pain shall be classified as category E.

(4) A seafarer who has—

- (a) osteo-arthritis shall be classified as category C for assessment; and
- (b) an advanced case of osteo-arthritis with disability shall be classified as category E.

(5) A seafarer who has—

- (a) a hernia shall be classified as category C until the hernia is repaired; and
- (b) a diaphragmatic hernia shall be classified according to the disability.

22. A seafarer who suffers from a speech defect that is likely to interfere with communication shall be classified as category E. Speech defects.

23. (1) A seafarer who suffers from—

Hearing.

- (a) acute and chronic otitis externa shall be classified as category C and shall be completely healed before returning to sea;
- (b) acute otitis media shall be classified as category C until satisfactorily treated; and
- (c) chronic otitis media shall be classified as category C but may be classified as category A or B after satisfactory treatment.

LAWS OF TRINIDAD AND TOBAGO

MINISTRY OF THE ATTORNEY GENERAL AND LEGAL AFFAIRS

www.legalaffairs.gov.tt

446

Chap. 50:10

Shipping

[Subsidiary]

Shipping (Medical Examination) Regulations

- (2) A seafarer who—
- (a) suffers from a loss of hearing with a degree of impairment that is sufficient to interfere with communication shall be classified as category E;
  - (b) is a serving seafarer and has suffered a unilateral, complete loss of hearing shall be assessed of this condition in relation to the job; and
  - (c) is a serving seafarer and is found to have impaired hearing acuity shall be referred for full investigation by a surgeon of the ear, nose and throat.

(3) A seafarer employed in the catering department who uses a satisfactory hearing aid may be allowed sea service where not hearing an instruction would not result in danger to the seafarer or others but the hearing aid shall be sufficiently effective to allow communication at normal conversational tones.

(4) A seafarer including an electrician and a radio officer who requires the use of a hearing aid shall not be permitted to work in, or be associated with, the deck or engine room departments.

PART C

*Visual Standards*

Diseases of the eye.

24. A person shall not be accepted for training or service at sea where he has—

- (a) an irremediable morbid condition of an eye or the lid of an eye, which is liable to risk of aggravation or recurrence;
- (b) diplopia, congenital night blindness, retinitis pigmentosa or any other serious or progressive disease of the eye; or
- (c) an homonymous or bitemporal defect which comes close to fixation where hemianopic or quadrantopic is present.

Binocular vision.

25. A person shall satisfy the standards for binocular vision set out in Table 1.

Monocular vision.

26. (1) Notwithstanding clause 25—
- (a) a monocular serving seafarer; or

UNOFFICIAL VERSION

UPDATED TO 31ST DECEMBER 2016

(b) a seafarer who becomes monocular during service at sea with no evidence of progressive disease in the remaining eye and who satisfies the standards for monocular vision set out in Table 2, may be allowed to continue service at sea.

(2) A seafarer shall be allowed a period of adaptation after becoming monocular, to enable him to descend and ascend stairs rapidly and safely.

27. (1) A seafarer who uses—

Visual aids.

- (a) visual aids, including spectacles or contact lenses, for the efficient performance of his duties; and
- (b) different visual aids for distant and near vision,

shall carry a spare set of each visual aid while seafaring.

(2) A seafarer who is required to use bifocal spectacles shall be allowed a period of adaptation during the initial use of the bifocal spectacles.

(3) A seafarer shall not be allowed to use aids to colour vision, including red-tinted, x-chroma, chromas lenses or chromagen lenses.

28. A seafarer, who has a pathological field defect, other than a new entrant, a deck officer and a monocular seafarer, shall have a field of vision at least 120 degrees in the horizontal, measured by the Goldman perimeter using the iii/4 setting (equivalent perimetry) and there shall be no significant defect in the binocular field which encroaches within 20 degrees of fixation above or below the meridian.

Pathological field defect.

29. (1) The colour vision of a deck officer and a rating shall be tested with Ishihara plates using the introductory plate and all the transformation and vanishing plates.

Colour vision.

(2) A candidate who fails the Ishihara colour plate test may request that his colour vision be re-tested using a Holmes Wright B lantern at an approved centre.

(3) The colour vision of a seafarer employed in the engine or radio department shall be tested using Ishihara plates, Farnsworth D15 test or City University test.

**LAWS OF TRINIDAD AND TOBAGO**

MINISTRY OF THE ATTORNEY GENERAL AND LEGAL AFFAIRS

www.legalaffairs.gov.tt

448

**Chap. 50:10**

*Shipping*

**[Subsidiary]**

*Shipping (Medical Examination) Regulations*

Standards for certain seafarers.

30. Notwithstanding clause 25, the following standards shall continue to apply to a seafarer in service before 1st August, 2002:

- (a) in the case of deck department personnel required to operate lifting plant, 6/9 for the better eye for aided visual acuity;
- (b) in the case of deck department personnel not required to perform watchkeeping duties or to operate lifting plant, 6/18 for the better eye for aided visual acuity; and
- (c) in the case of engineers, 6/60 for the other eye for aided visual acuity.

**TABLE 1**

Category of seafarer	Basic Visual Acuity Standard-unaided		Higher Visual Acuity Standard-aided if necessary		Near	Colour	Visual Field
	Better eye	Other eye	Better eye	Other eye			
Deck or dual career	6/60	6/60	6/6	6/12	N8	Ishihara or Lantern 2 miles	No pathological field defect
Engineer/ Radio	6/60	—	6/18	6/18	N8	Ishihara or Farnsworth D15 or City University	Sufficient to undertake duties efficiently
Others	Sufficient to undertake duties efficiently						

UNOFFICIAL VERSION

UPDATED TO 31ST DECEMBER 2016

**TABLE 2**

Category of sea-farer	Basic Visual Acuity Standard-unaided		Higher Visual Acuity Standard-aided if necessary		Near	Colour	Visual Field
Deck	6/60	—	6/6	—	N8	Ishihara or Lantern 2 miles	No pathological field defect
Engineer/ Radio	6/60	—	6/9	0	N8	Ishihara or Farnsworth D15 or City University	Sufficient to undertake duties efficiently
Others	Sufficient to undertake duties efficiently						

Regulation 5(2).  
[80/2002].

**SECOND SCHEDULE**



REPUBLIC OF TRINIDAD AND TOBAGO

**MEDICAL FITNESS CERTIFICATE**

ISSUED UNDER THE SHIPPING (MEDICAL EXAMINATION)  
REGULATIONS

Name of Seafarer ..... Discharge Book No.....

Date of Examination.....Date of Expiry of this Certificate.....

I.....certify that I have examined the seafarer  
*(Name of approved medical practitioner)*

named above in accordance with the Medical and Visual Standards for  
Seafarers contained in the First Schedule of the above-named Regulations and  
have found him/her\* fit for seafaring/subject to the following restrictions:\*

.....  
.....  
.....  
.....  
.....  
.....  
.....  
.....

Category of Seafarer.....

Official Stamp

Signed .....  
*(Approved medical practitioner)*

\*Delete as appropriate.

UNOFFICIAL VERSION

UPDATED TO 31ST DECEMBER 2016

THIRD SCHEDULE

Regulations  
5(3).  
[80/2002].

FORM OF NOTICE OF RESTRICTIONS OR UNFITNESS

TO:

This part to be  
completed by  
medical  
examiner.

Full Name..... Discharge Book No. ....

I have examined you in accordance with the standards of fitness  
for seafarers, as contained in the First Schedule of the Shipping  
(Medical Examination) Regulations, and found that you are—

( \* A(T) Fit for full range of duties but for restricted period  
only.

( \* B Fit for restricted service only.

(†D Indefinitely unfit for sea service. For review in  
..... months.

(†E Permanently unfit for sea service.

For the following reasons

.....  
.....

Official stamp  
or address and  
Telephone No.

Signed .....

Date .....

\*Restrictions, if applicable, will be detailed in the Medical Fitness Certificate.  
†delete if not applicable.

Any appeal against the above decision must be lodged within one month of  
the date of the examination.

Should you wish to appeal, you should complete the details requested below  
and send this completed form to:

The Director of Maritime Services,  
Maritime Services Division.

**LAWS OF TRINIDAD AND TOBAGO**

MINISTRY OF THE ATTORNEY GENERAL AND LEGAL AFFAIRS

www.legalaffairs.gov.tt

452

**Chap. 50:10**

*Shipping*

**[Subsidiary]**

*Shipping (Medical Examination) Regulations*

Before lodging an appeal you are advised to consult your usual medical practitioner and, should you wish to submit medical evidence in support of the appeal, you should arrange for this to be sent to the medical referee before the appointment date.

You will be advised of the name and address of the referee and the date for your appointment as soon as this has been arranged.

I wish to appeal against the above decision and request that arrangements be made for me to be examined by an independent medical referee.

This part to be completed by the person who is appealing.

I understand that I am entitled to present any medical evidence available to me in support of my case and agree to any medical report prepared by the above doctor being made available to the medical referee.

Signed..... Address.....

Name  
(in block  
letters).....

Telephone No. (if available) .....

[MED. 2]

FOURTH SCHEDULE

Regulation 11.  
 [80/2002].

In Confidence

RECORD OF MEDICAL EXAMINATION OF SEAFARERS

REPORT OF MEDICAL EXAMINATION BY AN  
 APPROVED MEDICAL PRACTITIONER

<p>1. Personal Details of Seafarer</p> <p>Surname.....</p> <p>Forenames.....</p> <p>Discharge Book No.....</p> <p style="text-align: center;"><i>Tick correct box</i></p> <p>Title Mr. <input type="checkbox"/> Mrs. <input type="checkbox"/> Miss <input type="checkbox"/> Ms. <input type="checkbox"/></p> <p>Any other title held.....</p> <p>Date of Birth.....</p> <p style="text-align: center;"><i>day month year</i></p> <p>Rank/Rating/Occupation.....</p> <hr/> <p>2. Usual Medical Practitioner or Medical Adviser?</p> <p>Name.....</p> <p>Address .....</p> <hr/> <p>3. Family Medical History</p> <p>Has any member of the seafarer's family ever suffered from:</p> <p style="text-align: center;"><i>Please tick correct box</i></p> <table style="width: 100%; border-collapse: collapse;"> <thead> <tr> <th></th> <th style="text-align: center;">Yes</th> <th style="text-align: center;">No</th> </tr> </thead> <tbody> <tr> <td>Hypertension</td> <td style="text-align: center;"><input type="checkbox"/></td> <td style="text-align: center;"><input type="checkbox"/></td> </tr> <tr> <td>Heart Condition</td> <td style="text-align: center;"><input type="checkbox"/></td> <td style="text-align: center;"><input type="checkbox"/></td> </tr> <tr> <td>Tuberculosis</td> <td style="text-align: center;"><input type="checkbox"/></td> <td style="text-align: center;"><input type="checkbox"/></td> </tr> <tr> <td>Asthma</td> <td style="text-align: center;"><input type="checkbox"/></td> <td style="text-align: center;"><input type="checkbox"/></td> </tr> <tr> <td>Diabetes</td> <td style="text-align: center;"><input type="checkbox"/></td> <td style="text-align: center;"><input type="checkbox"/></td> </tr> <tr> <td>Mental Disorder</td> <td style="text-align: center;"><input type="checkbox"/></td> <td style="text-align: center;"><input type="checkbox"/></td> </tr> <tr> <td>Epilepsy</td> <td style="text-align: center;"><input type="checkbox"/></td> <td style="text-align: center;"><input type="checkbox"/></td> </tr> </tbody> </table>		Yes	No	Hypertension	<input type="checkbox"/>	<input type="checkbox"/>	Heart Condition	<input type="checkbox"/>	<input type="checkbox"/>	Tuberculosis	<input type="checkbox"/>	<input type="checkbox"/>	Asthma	<input type="checkbox"/>	<input type="checkbox"/>	Diabetes	<input type="checkbox"/>	<input type="checkbox"/>	Mental Disorder	<input type="checkbox"/>	<input type="checkbox"/>	Epilepsy	<input type="checkbox"/>	<input type="checkbox"/>	<p>4. Previous Medical History</p> <p>Does the seafarer have a medical history of one of the following? If so (please tick the box).</p> <p>Hypertension <input type="checkbox"/></p> <p>Eye trouble/squint <input type="checkbox"/></p> <p>Stomach/bowel disorder <input type="checkbox"/></p> <p>ENT <input type="checkbox"/></p> <p>Hearing impaired <input type="checkbox"/></p> <p>Skin disease/allergies <input type="checkbox"/></p> <p>Heart condition/rheumatic fever <input type="checkbox"/></p> <p>Asthma/bronchitis <input type="checkbox"/></p> <p>Hay fever/allergies <input type="checkbox"/></p> <p>Epilepsy/fits/fainting <input type="checkbox"/></p> <p>Nervous/mental illness <input type="checkbox"/></p> <p>Jaundice/liver disease/piles <input type="checkbox"/></p> <p>Urinary disorders <input type="checkbox"/></p> <p>Back injury/pain <input type="checkbox"/></p> <p>Hernia <input type="checkbox"/></p> <p>Diabetes <input type="checkbox"/></p> <p>Female disorders <input type="checkbox"/></p> <p>Infectious/contagious/tropical diseases <input type="checkbox"/></p> <p>Malignant diseases <input type="checkbox"/></p> <p>Migraine/severe headaches <input type="checkbox"/></p> <p>Head injury/concussion <input type="checkbox"/></p> <p>Abnormal weight change <input type="checkbox"/></p> <p>Sexually transmitted diseases <input type="checkbox"/></p> <p>AIDS <input type="checkbox"/></p> <p>Tobacco intake (quantity).....</p> <p>Alcohol intake(quantity).....</p> <p>Other illnesses/operations</p> <p>Is the seafarer now receiving any treatment?.....</p> <p>I certify that this is a true statement</p> <p>Signature of Seaman.....</p>
	Yes	No																							
Hypertension	<input type="checkbox"/>	<input type="checkbox"/>																							
Heart Condition	<input type="checkbox"/>	<input type="checkbox"/>																							
Tuberculosis	<input type="checkbox"/>	<input type="checkbox"/>																							
Asthma	<input type="checkbox"/>	<input type="checkbox"/>																							
Diabetes	<input type="checkbox"/>	<input type="checkbox"/>																							
Mental Disorder	<input type="checkbox"/>	<input type="checkbox"/>																							
Epilepsy	<input type="checkbox"/>	<input type="checkbox"/>																							

**LAWS OF TRINIDAD AND TOBAGO**

MINISTRY OF THE ATTORNEY GENERAL AND LEGAL AFFAIRS

www.legalaffairs.gov.tt

454

**Chap. 50:10**

*Shipping*

[Subsidiary]

*Shipping (Medical Examination) Regulations*

Regulation 11.

**FOURTH SCHEDULE—Continued**

**5. Medical Examination**

Does the seafarer suffer from any of the following abnormalities?

*Please tick correct box and expand as necessary.*

- Tooth
- ENT
- Skin
- Heart
- Lungs
- Nervous system
- Varicose veins
- Genito-urinary, system
- Hernia

Any other defects .....

**6. Height (without shoes).....m.....cm**

Weight (stripped to waist).....kilos

Chest inspiration.....cm

Expiration.....cm

Pulse rate.....

Blood pressure systolic.....

5th Sound.....

Results of urine test:

Albumin.....

Sugar.....

Audiogram (if equipment is available)

Right ear	Khz	500	1,000	2,000	4,000	6,000	8,000
	dB						
Left ear	Khz	500	1,000	2,000	4,000	6,000	8,000
	dB						

Eye Test

Distant vision	Un-aided	R 6		L 6		Both 6	
	Aided	R 6		L 6		Both 6	

Near vision

Unaided N
Aided N

Colour vision

Ishihare	Engineers modified
Normal	Defective

7. Results Medical Examination

The Standards of Medical Examination Regulations have been or have not been met.

*Please tick correct box*

A. Unrestrictive sea service

E. Permanently

B. Restrictive service only

D. Indefinitely

Restriction..... (Review in.....months)

Period of restriction..... C. Temporarily

(Review in.....weeks)

Medical Practitioner's  
Official Stamp

Signature.....

Name.....  
(Block letters)

Date .....

[Med. 3]

\_\_\_\_\_

Regulation 11.  
[80/2002].

**FIFTH SCHEDULE**  
**MEDICAL PRACTITIONERS ANNUAL RETURN OF MEDICAL EXAMINATIONS OF SEAFARERS**

Return for Period.....  
 Medical Practitioner's Name.....  
 Address of Surgery.....  
 .....  
 .....

(Details should only be entered in the columns below when a full certificate of fitness has not been granted. Appropriate boxes should be ticked to show reasons for failure. If you need more space continue on another form).

BREAKDOWN OF REASONS FOR REFUSALS:	(Use one column for each examination)																								
	1	2	3	4	5	6	7	8	9	10	11	12	13	14	15	16	17	18	19	20	21	22	23	24	
Infectious/contagious diseases																									
Malignant neoplasms																									
Eyesight																									
ENT																									
Speech defects																									
Respiratory system																									
Cardiovascular system																									
Disease of veins																									
Gastrointestinal system																									

Regulation 11.  
 [80/2002].

**FIFTH SCHEDULE — Continued**

BREAKDOWN OF REASONS FOR REFUSALS:	(Use one column for each examination)																								
	1	2	3	4	5	6	7	8	9	10	11	12	13	14	15	16	17	18	19	20	21	22	23	24	
Skin																									
Sexually transmissible diseases																									
Genito-urinary system																									
Gynaecological disorder																									
Endocrine disease/metabolic disorder																									
Central nervous system																									
Alcohol abuse																									
Musculo/skeletal system																									
Psychiatric disorders																									
BREAKDOWN OF REASONS FOR RESTRICTIONS:																									
Infectious/contagious diseases																									
Malignant neoplasms																									
Eyesight																									
ENT																									
Speech defects																									

Regulation 11.  
[80/2002].

**FIFTH SCHEDULE—Continued**

BREAKDOWN OF REASONS FOR RESTRICTIONS:	(Use one column for each examination)																								
	1	2	3	4	5	6	7	8	9	10	11	12	13	14	15	16	17	18	19	20	21	22	23	24	
Respiratory system																									
Cardiovascular system																									
Disease of veins																									
Gastrointestinal system																									
Skin																									
Sexually transmissible diseases																									
Genito-urinary system																									
Gynaecological disorder																									
Endocrine disease/metabolic disorder																									
Central nervous system																									
Alcohol abuse																									
Musculo/skeletal system																									
Psychiatric disorders																									
<b>SUMMARY</b>																									
TOTAL NO. OF APPLICATIONS DURING THIS PERIOD																									
TOTAL ISSUED WITHOUT RESTRICTIONS THIS PERIOD																									
TOTAL ISSUED WITH RESTRICTIONS THIS PERIOD																									
TOTAL REFUSED THIS PERIOD																									

[Med. 4]

Please return completed form to: The Director of Maritime Services, Maritime Services Division.

## SHIPPING (LOAD LINE) REGULATIONS

### ARRANGEMENT OF REGULATIONS

#### REGULATION

1. Citation and commencement.

#### PART I

#### GENERAL

2. Definitions.
3. Application.

#### PART II

#### APPROPRIATE LOAD LINES AND ZONES

4. Appropriate load lines.
5. Applicable zones, areas and periods.
6. Load line of ship one hundred metres or less.
7. Load line of sailing ship.
8. Load line of ship with all seasons load line.
9. Load line of ship with timber load line.

#### PART III

#### SURVEYS AND CERTIFICATES

10. Application for survey.
11. Production of documents and information.
12. Load line surveys.
13. Report of survey.
14. Assignment of freeboards.
15. Load line Certificates.
16. Period of validity.
17. Extension of Load Line Certificates.
18. Cancellation.
19. Periodical inspection of ships.
20. Exemption and Exemption Certificate.

**LAWS OF TRINIDAD AND TOBAGO**

MINISTRY OF THE ATTORNEY GENERAL AND LEGAL AFFAIRS

www.legalaffairs.gov.tt

460

**Chap. 50:10**

*Shipping*

[Subsidiary]

*Shipping (Load Line) Regulations*

ARRANGEMENT OF REGULATIONS—(Continued)

**REGULATION**

**PART IV**

**LOAD LINES AND MARKS**

21. Appropriate marks.
22. Marking.
23. Deck-line.
24. Load line mark.
25. Load lines.
26. Timber Load Lines.
27. Appropriate load line.
28. Position of load lines.
29. Method of marking.
30. Authorisation of removal, etc., of appropriate marks.
31. Mark of Assigning Authority.

**PART V**

**CONDITIONS OF ASSIGNMENT**

32. Requirements for the assignment of freeboards.
33. Compliance with conditions of assignment.
34. Record of Particulars.

**PART VI**

**FREEBOARDS**

35. Types of freeboards.
36. Determination of freeboards.
37. Minimum freeboard.
38. Greater than minimum freeboard.
39. Less than minimum freeboard.
40. Depth of loading.
41. Special position of deck-line and correction of freeboards.

**PART VII**

**STABILITY, LOADING, AND BALLASTING  
INFORMATION**

42. Information as to the stability of ships.
43. Information as to loading and ballasting of ships.

UNOFFICIAL VERSION

UPDATED TO 31ST DECEMBER 2016

**PART VIII**

**RECOGNITION OF OTHER LOAD LINE CERTIFICATES**

44. Recognition of Certificates issued by other Governments.

**FIRST SCHEDULE.**

**SECOND SCHEDULE.**

**THIRD SCHEDULE.**

**FOURTH SCHEDULE.**

**FIFTH SCHEDULE.**

**SIXTH SCHEDULE.**

**SEVENTH SCHEDULE.**

**EIGHTH SCHEDULE.**

**NINTH SCHEDULE.**

**TENTH SCHEDULE.**

3/1993.

**SHIPPING (LOAD LINE) REGULATIONS**

*made under section 280*

Citation and commencement.

1. (1) These Regulations may be cited as the Shipping (Load Line) Regulations.

(2) These Regulations come into operation on the 1st day of June, 1992.

**PART I**

**GENERAL**

Definitions.

2. In these Regulations—

“Act” means the Shipping Act;

“Administration” means the Government of the State whose flag the ship is flying;

“amidships” means the middle of the ship’s length (L);

“Assigning Authority” means the Maritime Services Division or any person authorised as such by the Minister for the purposes of these Regulations and includes in particular, where so authorised, Lloyd’s Register of Shipping, Bureau Veritas, Det Norske Veritas, Germanischer Lloyd and the American Bureau of Shipping;

“breadth” and the symbol (B) in relation to a ship means the maximum breadth of the ship measured amidships to the moulded line of the frame in the case of a ship having a metal shell, or to the outer surface of the hull in the case of a ship having a shell of any other material;

“Convention ship” means a load line convention ship as defined in section 277 of the Act;

“Convention country” means a convention country as defined in section 277 of the Act;

24/1993.

“deck cargo regulations” means the Shipping Load Lines (Deck Cargo) Regulations, 1992;

“existing ship” means a ship which is not a new ship;

“freeboard” means the distance measured vertically downwards amidships from the upper edge of the deck line described in regulation 23 to the position at which the upper edge of the load line appropriate to the freeboard is to be marked;

“freeboard deck” in relation to a ship means the deck from which the freeboards assigned to the ship are calculated, being either—

- (a) the uppermost complete deck exposed to weather and sea, which has permanent means of closing all openings in its weather portions, and below which all openings in the sides of the ship are fitted with permanent means of watertight closing; or
- (b) at the request of the owner and subject to the approval of the Minister, a deck lower than that described in paragraph (a), subject to its being a complete and permanent deck which is continuous both—
  - (i) in a fore and aft direction at least between the machinery space and peak bulk-heads of the ship; and
  - (ii) athwartships;

“length” and the symbol (L) in relation to a ship means the greater of the following distances:

- (a) the distance between the fore side of the stem and the axis of the rudder stock; or
- (b) a distance measured from the fore side of the stem, being ninety-six per cent of the distance between that point and the aft side of the stern;

“Load Line Certificate” means a Load Line Certificate issued under these Regulations;

“Load Line Convention” means Load Line Convention as defined in section 277 of the Act;

“moulded depth” in relation to a ship means the vertical distance measured from the top of the keel to the top of the freeboard deck beam at side, save that—

- (a) in the case of wood or composite ship, it shall be measured from the lower edge of the keel rabbet;

- (b) if the form at the lower part of the midship section of the ship is of a hollow character, or if thick garboards are fitted, it shall be measured from the point where the line of the flat of the bottom continued inwards cuts the side of the keel;
- (c) if the case of a ship having rounded gunwales, it shall be measured to the point of intersection of the moulded lines of the deck and side shell plating, the lines extending as though the gunwale were of angular design;
- (d) if the freeboard deck is stepped and the raised part of the deck extends over the point at which the moulded depth is to be determined, it shall be measured to a line of reference from the lower part of the deck along a line parallel to the raised part of the deck;

“new ship” means a ship whose keel is laid or which is at a similar stage of construction on or after—

- (a) in the case of a ship registered in or flying the flag of a State other than Trinidad and Tobago which is a Convention country, the date from which it is declared that the Government of that State has ratified or acceded to the Load Line Convention, or that it is a State to which that Convention applies;
- (b) in the case of any other ship the 21st July, 1968;

“sailing ship” means a ship designed to carry sail, whether as the sole means of propulsion or as a supplementary means;

“Surveyor” means a surveyor appointed by an Assigning Authority.

Application.

**3.** These Regulations shall apply to every Trinidad and Tobago ship other than—

- (a) ships of War;
- (b) pleasure yachts; and
- (c) fishing vessels.

**PART II**

**APPROPRIATE LOAD LINES AND ZONES**

**4.** Subject to regulations 6 to 9, the load line appropriate to a ship shall be— Appropriate load lines.

- (a) the Summer load line when the ship is in a summer zone, excluding any part of such a zone which is to be regarded as a seasonal area in relation to the ship;
- (b) the Tropical load line when the ship is in the tropical zone; and
- (c) when the ship is in a seasonal zone or area, including any part of a summer zone which is to be regarded as a seasonal area in relation to the ship, the Summer load line, the Winter load line or the Tropical load line according to whether the seasonal period applicable in that zone or area to that ship is respectively summer, winter or tropical.

**5.** The zones, the seasonal zones, seasonal areas and seasonal periods applicable to a ship, shall be those set out in the Second Schedule and shown by way of illustration on the Chart annexed to these Regulations. Applicable zones, areas and periods.  
Second Schedule.

**6.** In the case of a ship of one hundred metres or less in length the appropriate load line shall be the Winter North Atlantic Load Line in— Load line of ship one hundred metres or less.

- (a) the North Atlantic Winter Seasonal Zone I as described in paragraph 1 of the Second Schedule;
- (b) so much of the North Atlantic Winter Seasonal Zone II, as so described, as lies between the meridians of longitude of 15° 00' west and 50° 00' West,

during the winter seasonal periods respectively applicable in those zones.

**LAWS OF TRINIDAD AND TOBAGO**

MINISTRY OF THE ATTORNEY GENERAL AND LEGAL AFFAIRS

www.legalaffairs.gov.tt

466

**Chap. 50:10**

*Shipping*

[Subsidiary]

*Shipping (Load Line) Regulations*

Load line of sailing ship.

**7.** In the case of a sailing ship the appropriate load line shall, except in circumstances in which regulation 6 applies, be the Summer load line.

Load line of ship with all seasons load line.

**8.** In the case of a ship marked with an All Seasons load line in accordance with regulation 38 that load line shall be the appropriate load line in all circumstances.

Load line of ship with timber load line.

**9.** In the case of a ship marked with Timber load lines and carrying timber deck cargo in accordance with the requirements of the deck cargo regulations, the load line to be observed in any particular circumstances shall be the Timber load line corresponding to the load line which would be applicable in those circumstances under regulations 4 to 8 if the ship were not so marked.

**PART III**

**SURVEYS AND CERTIFICATES**

Application for survey.

**10.** An application for the survey of a ship for the purposes of assignment of freeboard and for the issue of the load line certificate to the ship shall be made to the Assigning Authority by or on behalf of the owner of the ship and where the Assigning Authority is not the Maritime Services Division the owner or his representative shall forward a copy of the application to the Director of Maritime Services.

Production of documents and information.

**11.** The owner of the ship or his representative shall furnish to the Assigning Authority such plans, drawings, specifications and other documents and information relating to the design and construction of the ship as the Assigning Authority may require.

Load line surveys.

**12.** (1) After receipt of the application and the documents together with other relevant information required by regulation 11, the Assigning Authority shall cause the ship to be surveyed by a surveyor in order to ascertain—

Fourth Schedule.

(a) whether the ship complies with such of the requirements of Part V and the Fourth Schedule as are applicable; and

UNOFFICIAL VERSION

UPDATED TO 31ST DECEMBER 2016

(b) what other data is required—

- (i) for the determination of the freeboard which is to be assigned to the ship in accordance with Part VI and the Fifth Schedule; and Fifth Schedule.
- (ii) to enable the stability information to be supplied to the master of the ship pursuant to Part VII of these Regulations and Part III of the Seventh Schedule. Seventh Schedule.

(2) In the course of the survey of a ship pursuant to subregulation (1), the ship and any of its fittings shall be submitted to such tests as may, in the opinion of the Assigning Authority, be necessary to ascertain that the ship complies with the requirements of subregulation (1), and any test pertaining to the stability of a ship shall be subject to the requirements of Parts I and II of the Seventh Schedule. Seventh Schedule.

(3) The owner or any other person on his behalf applying for the survey of the ship under regulation 10 shall afford all necessary facilities for such survey and shall, at the request of the Assigning Authority, furnish, for the Assigning Authority's use and retention, if necessary, such further documents and information as the Assigning Authority may require.

**13.** (1) On completion of the survey referred to in regulation 12 the surveyor shall submit a report of survey to the Assigning Authority giving the results of the survey and his findings on the condition of the ship with reference to the requirements of regulation 12. Report of survey.

(2) The report of survey shall be accompanied by—

- (a) the Record of Particulars, in the form set out in the Third Schedule, complying with the requirements of regulation 34; and Third Schedule.
- (b) the computations of freeboard complying with the requirements of Part VI and the Fifth Schedule. Fifth Schedule.

LAWS OF TRINIDAD AND TOBAGO

MINISTRY OF THE ATTORNEY GENERAL AND LEGAL AFFAIRS

www.legalaffairs.gov.tt

468

Chap. 50:10

Shipping

[Subsidiary]

Shipping (Load Line) Regulations

Tenth Schedule. (3) In the case of any ship which is required to comply with the requirements of Part I of the Seventh Schedule relating to stability the surveyor shall furnish to the Assigning Authority, in the form set out in the Tenth Schedule, such information as may be necessary to determine whether the ship complies with these requirements.

(4) The Assigning Authority shall determine whether or not the ship complies with the requirements referred to in subregulation (3) and if she so complies the stability shall be approved by the Maritime Services Division or by the Assigning Authority where the Minister so directs.

Assignment of freeboards.

Fifth Schedule.

**14.** (1) The Assigning Authority shall, if satisfied on scrutiny of the report of survey that the ship complies with the applicable requirements of Part V and the Fourth Schedule, assign freeboards to the ship which have been determined in accordance with Part VI and the Fifth Schedule.

(2) On assignment of freeboards, the Assigning Authority shall furnish to the owner of the ship—

(a) particulars of freeboards so assigned;

(b) directions specifying—s

(i) the load lines to be marked on the ship in accordance with the requirements of Part IV.

(ii) the position in which those load lines, the deck line and the load line mark are to be so marked; and

(c) two copies of the Record of Particulars.

(3) Where the Assigning Authority is not the Maritime Services Division then the Assigning Authority shall forward to the Director of Maritime Services a copy of the documents and information specified in subregulation (2).

Load line Certificates.

**15.** (1) Subject to regulation 20 the Assigning Authority shall, on being satisfied that the ship has been duly marked in accordance with the directions given to the owner of the ship

UNOFFICIAL VERSION

UPDATED TO 31ST DECEMBER 2016

under regulation 14, issue either an International Load Line Certificate (1966) or a Trinidad and Tobago Load Line Certificate as may be required by section 282 of the Act, in the form set out for such Certificates in the First Schedule.

First  
Schedule.

(2) Where the Assigning Authority is not the Maritime Services Division then the Assigning Authority shall forward to the Director of Maritime Services a copy of the Load Line Certificate issued to the ship.

**16.** Every Load Line Certificate issued under these Regulations shall be valid until a date to be determined by the Assigning Authority, not being a date more than five years after the date of completion of survey of the ship under regulation 12 and such date shall be specified by the Assigning Authority in every certificate issued by it, failing which the certificate shall not be deemed to be a valid certificate.

Period of  
validity.

**17.** (1) Where any ship, in respect of which a Load Line Certificate is in force, has been surveyed following an application made by the owner for the issue of a new certificate to take effect on the expiry date of the current certificate, the Assigning Authority may—

Extension of  
Load Line  
Certificate.

- (a) if satisfied, following scrutiny of the surveyor's report that the ship complies with the applicable requirements of Part V and of the Fourth Schedule relating to conditions of assignment; and
- (b) if satisfied that the ship complies with the requirements of the Fourth and Seventh Schedules, as applicable, relating to stability,

Fourth and  
Seventh  
Schedules.

extend the validity of the current certificate of the ship for a period not exceeding five months, if it is considered that it is not reasonably practicable to issue a new certificate and in every such case a new certificate shall be issued after the date on which the extended certificate expires.

LAWS OF TRINIDAD AND TOBAGO

MINISTRY OF THE ATTORNEY GENERAL AND LEGAL AFFAIRS

www.legalaffairs.gov.tt

470

Chap. 50:10

Shipping

[Subsidiary]

Shipping (Load Line) Regulations

(2) No extension granted under subregulation (1) shall have effect unless particulars of the date to which the period of validity is extended, together with particulars of the place at and the date on which such extension was so given, are endorsed by the Assigning Authority on the current certificate.

(3) The period of validity of any Load Line Certificate coming into effect immediately on the expiry of a certificate extended pursuant to this Regulation shall not exceed a period of five years commencing on the date of completion of the survey referred to in subregulation (1).

Cancellation.

**18.** (1) The Minister may cancel a Load Line Certificate—

(a) if satisfied, whether by a report from the Assigning Authority or otherwise, that—

(i) the ship to which the certificate relates does not comply with the conditions of assignment; or

(ii) the structural strength of the ship is lowered to such an extent that the ship is unsafe; or

(iii) information on the basis of which freeboards were assigned to the ship was incorrect in a material particular;

(b) if the certificate is not endorsed in accordance with the requirements of regulation 19 to show that the ship has been inspected in accordance with the requirements of that Regulation;

(c) if a new certificate is issued in respect of the ship;

(d) if the ship was registered in Trinidad and Tobago when the certificate was issued and has since ceased to be registered.

(2) In every such case the Minister shall notify the owner of the ship in writing of the cancellation specifying the grounds for cancellation and the date on which it is to take effect.

UNOFFICIAL VERSION

UPDATED TO 31ST DECEMBER 2016

**19.** (1) Every ship in respect of which a Load Line Certificate is in force shall be periodically inspected by a surveyor in accordance with this Regulation in order to ensure that—

Periodical inspection of ships.

- (a) the fittings and appliances for the protection of openings, the guard rails, the freeing ports and the means of access to the crew's quarters in the ship are in an effective condition; and
- (b) no changes have been made or taken place in the hull of superstructures of the ship such as to render no longer accurate, data on the basis of which freeboards were assigned to the ship.

(2) Application for the inspection shall be made by or on behalf of the owner of the ship to the Assigning Authority, who shall appoint a surveyor to carry out the inspection.

(3) The surveyor, referred to in subregulation (2), may in the course of any such inspection require the carrying out of tests considered by him to be necessary to establish that the ship complies with the requirements of subregulation (1).

(4) Inspection of a ship pursuant to this Regulation shall be carried out on or within three months before or after each anniversary of the date of completion of the survey leading to the issue of the certificate and, unless the Minister otherwise consents, the intervals between inspections shall not be less than nine months or more than fifteen months.

(5) The Surveyor, if satisfied after inspection that the ship complies with the requirements of subregulation (1), shall endorse a record of the inspection and of the fact—

- (a) in the case of an International Load Line Certificate (1966), that the ship was found to comply with the relevant provisions of the Convention; and
- (b) in the case of a Trinidad and Tobago Load Line Certificate, that the ship was found to comply with the relevant provisions of these Regulations,

on the Load Line Certificate in the space provided, specifying the Assigning Authority by which he was appointed to carry out the inspection.

Exemption and  
Exemption  
Certificate.

**20.** (1) Where the Minister exempts any ship pursuant to section 287 of the Act, the Director shall issue in respect of such ship an International Load Line Exemption Certificate or a Trinidad and Tobago Load Line Exemption Certificate in the form set out for such certificates in the First Schedule.

(2) Save in so far as the nature and terms of any such exemption require to the contrary, regulations 10 to 14 and regulations 16 to 19 shall apply to any ship so exempted and to any Exemption Certificate so issue to any such ship in the like manner as they apply to any other ship except that—

- (a) references in the Regulations to the Assigning Authority shall be deemed to be references to the Minister; and
- (b) instead of as provided in regulation 19(5) the Surveyor, if satisfied after inspection that the ship continues to comply with the conditions subject to which the exemption was granted, shall endorse the Exemption Certificate to that effect in the space provided and date and sign the endorsement.

#### PART IV

#### LOAD LINES AND MARKS

Appropriate  
marks.

**21.** In this Part the expression “the appropriate marks” in relation to a ship means the load lines, the deck line and the load line mark directed to be marked on the ship pursuant to regulation 14.

Marking.

**22.** On receipt from the Assigning Authority of the particulars and directions referred to in regulation 14, the owner of the ship shall cause the appropriate marks to be made on each side of the ship in accordance with the directions and the requirements of this Part.

**23.** (1) The deck line shall consist of a horizontal line 300 millimetres in length and 25 millimetres in width and shall be marked amidships on each side of the ship in accordance with subregulations (2) and (3) so as to indicate the position of the freeboard deck. Deck-line.

(2) Subject to subregulation (3), the deck line shall be marked in such a position on the side of the ship that its upper edge passes through the point amidships where the continuation outwards of the upper surface of the freeboard deck, or of any sheathing of that deck, intersects the outer surface of the shell of the ship as shown in Figure 1 of the Eleventh Schedule.

Eleventh  
Schedule.

(3) Where the design of the ship or other circumstances render it, in the opinion of the Assigning Authority, impracticable to mark the deck line in accordance with subregulation (2), the Authority may include in the directions given pursuant to regulation 14 a direction that it may be marked by reference to another fixed point in the ship as near as practicable to the position described in subregulation (2).

**24.** (1) The load line mark shall consist, as shown in Figure 2 of the Eleventh Schedule, of a ring 300 millimetres in outside diameter and 25 millimetres wide, intersected by a horizontal line 450 millimetres long and 25 millimetres wide, the upper edge of which passes through the centre of the ring. Load line mark.

(2) The centre of the ring, referred to in subregulation (1), shall be marked amidships vertically below the deck line, so that, except as otherwise provided in regulation 38, the distance from the centre of the ring to the upper edge of the deck line is equal to the Summer Freeboard assigned to the ship.

**25.** (1) Load Lines as described in this Regulation and regulation 26 indicate the maximum depth to which a ship marked therewith may be loaded in the circumstances described in regulations 4 to 9 and the Second Schedule. Load lines.

(2) Except as otherwise provided in subregulation (4), regulation 26 and regulation 38, load lines shall consist, as shown in Figure 2 of the Eleventh Schedule, of horizontal lines each 230 millimetres in length and 25 millimetres in width extending forward or abaft of a vertical line 25 millimetres in width marked 540 millimetres forward of the centre of the ring of the load line mark and at right angles to that line, and individual load lines shall be as follows:

- (a) the Summer Load Line, which shall extend forward of the vertical line and be marked S, and shall correspond horizontally with the line passing through the centre of the ring of the load line mark;
- (b) the Winter Load Line, which shall extend forward of the vertical line and be marked W;
- (c) the Winter North Atlantic Load Line, which shall extend forward of the vertical line and be marked WNA;
- (d) the Tropical Load Line, which shall extend forward of the vertical line and be marked T;
- (e) the Fresh Water Load Line which shall extend abaft the vertical line and be marked F;
- (f) the Tropical Fresh Water Load Line, which shall extend abaft the vertical line and be marked TF.

(3) The maximum depth of loading referred to in subregulation (1) shall be the depth indicated by the upper edge of the appropriate load line.

(4) In the case of a sailing ship—

- (a) the Summer Load Line shall consist of the line passing through the centre of the ring of the load line mark; and
- (b) the Winter North Atlantic Load Line and Fresh Water Load Line only shall be marked on the ship as shown in Figure 4 of the Eleventh Schedule.

**26.** (1) Timber Load Lines shall consist, as shown in Figure 3 of the Eleventh Schedule, of horizontal lines of the dimensions specified in respect of such lines in regulation 25, extending abaft or forward of a vertical line of the dimensions specified in respect of such a line in that Regulation, marked 540 millimetres abaft the centre of the ring of the Load Line mark and at right angles to that line.

Timber Load Lines.

(2) Individual Timber Load Lines shall be as follows:

- (a) the Summer Timber Load Line, which shall extend abaft the vertical line referred to in subregulation (1) and be marked LS;
- (b) the Winter Timber Load Line, which shall extend abaft the vertical line and be marked LW;
- (c) the Winter North Atlantic Timber Load Line, which shall extend abaft the vertical line and be marked LWNA;
- (d) the Tropical Timber Load Line, which shall extend abaft of the vertical line and be marked LT;
- (e) the Fresh Water Timber Load Line, which shall extend forward of the vertical line and be marked LF;
- (f) the Tropical Fresh Water Timber Load Line, which shall extend forward of the vertical line and be marked LTF.

(3) The maximum depth of loading referred to in regulation 25(1) shall be the depth indicated by the upper edge of the appropriate Timber Load Line.

**27.** The appropriate load line in respect of a ship at any particular place and time shall be ascertained in accordance with regulations 4 to 9 and the Second Schedule.

Appropriate load line.

**28.** Each load line required to be marked on a ship shall be marked in such a position on each side of the ship that the distance measured vertically downwards from the upper edge of the deck-line to the upper edge of the load line is equal to the freeboard assigned to the ship which is appropriate to that load line.

Position of load lines.

LAWS OF TRINIDAD AND TOBAGO

MINISTRY OF THE ATTORNEY GENERAL AND LEGAL AFFAIRS

www.legalaffairs.gov.tt

476

Chap. 50:10

Shipping

[Subsidiary]

Shipping (Load Line) Regulations

Method of marking.

**29.** (1) The appropriate marks shall be marked on each side of the ship in accordance with the following requirements in such a manner as to be plainly visible:

- (a) if the sides of the ship are of metal, the appropriate marks shall be cut in, centre punched or welded;
- (b) if the sides of the ship are of wood, the marks shall be cut into the planking to a depth of not less than three millimetres;
- (c) if the sides are of other materials to which the foregoing methods of marking cannot effectively be applied, the marks shall be permanently affixed to the sides of the ship by bonding or some other effective method.

(2) The appropriate marks shall be painted in white or yellow if the background is dark, and in black if the background is light.

Authorisation of removal, etc., of appropriate marks.

**30.** After the appropriate marks have been made on a ship, the marks may not be concealed, removed, altered, defaced or obliterated except under the authority of an Assigning Authority.

Mark of Assigning Authority.

**31.** (1) The mark of the Assigning Authority as described in subregulation (2) may be made on each side of the ship in a position alongside the load line mark either above the horizontal line forming part of that mark, or above and below it.

(2) The Assigning Authority's mark for this purpose shall consist of not more than four initials to identify the Authority's name, each measuring approximately 115 millimetres in height and 75 millimetres in width.

PART V

CONDITIONS OF ASSIGNMENT

Requirements for the assignment of freeboards. Fourth Schedule.

**32.** (1) Except as otherwise provided in subregulations (2) and (3), every ship to which freeboards are to be assigned under these Regulations shall comply with the requirements applicable to it under Part I of the Fourth Schedule.

UNOFFICIAL VERSION

UPDATED TO 31ST DECEMBER 2016

(2) Every ship, being—

- (a) a ship of Type “A” to which the requirements of Part II of the Fourth Schedule apply; or
- (b) a ship of Type “B” to which the requirements of Part III of the Fourth Schedule apply; or
- (c) a ship to be assigned with timber freeboards, to which the requirements of Part IV of the Fourth Schedule apply,

Fourth  
Schedule.

shall, in addition to complying with the respective Part of the Fourth Schedule, also comply with the requirements of Part I of the Schedule except in so far as compliance with Parts II, III and IV, as the case may be, of the Schedule otherwise requires.

(3) Every existing ship, not being a ship to which freeboards are to be assigned in accordance with regulation 36(1) by virtue of regulation 36(2), shall comply with the requirements laid down in the Eighth Schedule.

Eighth  
Schedule.

**33.** (1) Except as otherwise provided in subregulation (2), a ship shall be regarded as not in compliance with the conditions of assignment—

Compliance  
with conditions  
of assignment.

- (a) if at any time after the assignment of freeboards to the ship, there has been any alterations to the hull, superstructure, fittings or appliances of the ship to such extent that either—
  - (i) any requirement applicable to the ship under regulation 32 is not complied with in respect of the ship; or
  - (ii) the Record of Particulars made in relation to the ship pursuant to regulation 34 is rendered inaccurate in a material respect; or
- (b) if the Record of Particulars is not kept on board the ship in accordance with regulation 34(3).

(2) Notwithstanding any alterations to the ship as described in subregulation (1)(a), a ship shall be deemed to be in

LAWS OF TRINIDAD AND TOBAGO

MINISTRY OF THE ATTORNEY GENERAL AND LEGAL AFFAIRS

www.legalaffairs.gov.tt

478

Chap. 50:10

Shipping

[Subsidiary]

Shipping (Load Line) Regulations

compliance with the conditions of assignment if either—

- (a) new freeboards have been assigned to the ship appropriate to the condition of the ship after the alterations and the ship has been marked with the appropriate load lines and a new certificate has been issued to the owner; or
- (b) the alterations have been inspected by a surveyor on behalf of the Assigning Authority, and the Authority is satisfied that the alterations are not such as to require any change in the freeboards assigned to the ship and full particulars of the alterations, together with the date and place of inspection, have been endorsed by the surveyor on the record of particulars.

Record of Particulars.

**34.** (1) A Record of Particulars in the form prescribed in the Third Schedule shall form part of the surveyor's Report such that—

Third Schedule.

- (a) in the case of a ship to which an International Load Line Certificate is to be issued, the front page of the Record of Particulars shall be in the form of Record 2 of the Third Schedule and the references in parentheses to paragraphs of the Fourth Schedule, where shown above the headings of certain pages of the record, shall be omitted;

Fourth Schedule.

- (b) in the case of a ship to which a Trinidad and Tobago Load Line Certificate is to be issued the front page of the Record of Particulars shall be in the form of Record 1 of the Third Schedule.

Third Schedule.

(2) The Record of Particulars shall be completed by the surveyor carrying out the survey of the ship pursuant to regulation 12 and shall be furnished by him to the Assigning Authority in accordance with the provisions of regulation 13 and two copies of the Record shall be sent by the Assigning Authority to the owner of the ship together with the particulars and directions required to be so furnished in regulation 14.

UNOFFICIAL VERSION

UPDATED TO 31ST DECEMBER 2016

(3) One copy of the Record of Particulars furnished by the Assigning Authority to the owner of the ship shall, at all times, be kept on board the ship in the custody of the Master.

(4) Where the Assigning Authority is not the Maritime Services Division then the Assigning Authority shall forward to the Director of Maritime Services a copy of the Record of Particulars.

#### PART VI

#### FREEBOARDS

**35.** The freeboards which may be assigned to a ship under these Regulations shall be— Types of freeboards.

- (a) Summer freeboard;
- (b) Tropical freeboard;
- (c) Winter freeboard;
- (d) Winter North Atlantic freeboard;
- (e) Fresh Water freeboard;
- (f) Tropical Fresh Water freeboard;
- (g) Summer Timber freeboard;
- (h) Winter Timber freeboard;
- (i) Winter North Atlantic Timber freeboard;
- (j) Tropical Timber freeboard;
- (k) Fresh Water Timber freeboard; and
- (l) Tropical Fresh Water Timber freeboard.

**36.** (1) Except otherwise provided in regulation 37— Determination of freeboards.

- (a) the freeboards to be assigned to a new ship shall be determined in accordance with the Fifth Schedule; and Fifth Schedule.
- (b) the freeboards to be assigned to an existing ship shall be determined in accordance with the Eighth Schedule. Eighth Schedule.

(2) Where an existing ship has been so constructed or altered as to comply with the requirements of the Fourth Schedule Fourth Schedule.

LAWS OF TRINIDAD AND TOBAGO

MINISTRY OF THE ATTORNEY GENERAL AND LEGAL AFFAIRS

www.legalaffairs.gov.tt

480

Chap. 50:10

Shipping

[Subsidiary]

Shipping (Load Line) Regulations

applicable to a new ship of its type, and an application is made in respect of such ship for the assignment of freeboards determined in accordance with the Fifth Schedule, such freeboards may be assigned to the ship.

Minimum  
freeboard.

**37.** A freeboard determined in accordance with the preceding Regulations of this Part is hereafter referred to in regulations 38 and 39 as a minimum freeboard.

Greater than  
minimum  
freeboard.

**38.** Any ship may, on the application of the owner made in that behalf, be assigned a freeboard greater than the minimum freeboard determined in accordance with regulation 36, subject to the following conditions, namely—

- (a) on survey of the ship pursuant to regulation 12, the Assigning Authority is satisfied that the ship complies with—
  - (i) Part V of these Regulations;
  - (ii) the Fourth Schedule, other than provisions relating to stability;
  - (iii) Part VII of these Regulations in so far as relates to stability; and
  - (iv) the Seventh Schedule in so far as relates to stability;
- (b) the ship is not assigned with timber freeboards;
- (c) where the greater than minimum freeboard to be assigned to the ship is such that the position of load lines on the sides of the ship appropriate to that freeboard would correspond to, or be lower than the position at which the lowest of the load lines appropriate to minimum freeboards for that ship would have been marked—
  - (i) only the load lines appropriate to the greater than minimum freeboard and the fresh water freeboard shall be marked on the sides of the ship;

UNOFFICIAL VERSION

UPDATED TO 31ST DECEMBER 2016

- (ii) the load line appropriate to the greater than minimum freeboard shall be called the “All seasons load line” which shall consist of a horizontal line intersecting the load line mark and such mark shall be placed accordingly;
- (iii) the vertical line described in regulation 25(2) shall be omitted; and
- (iv) subject to subparagraph (iii) the Fresh Water Load Line shall be as described in regulation 25(2) and shall be marked accordingly.

**39.** On an application made in this behalf by the owner of a hopper type ship, which is engaged on voyages other than international voyages during the course of which it does not go farther than 20 miles from the nearest land at any time the Minister may, subject to the conditions set out in Part III of the Fifth Schedule, assign such ship a less than minimum freeboard reduced to—

Less than minimum freeboard.

Fifth Schedule.

- (a) five-eighths of the appropriate minimum freeboard determined in accordance with Table B of the Sixth Schedule; or
- (b) one-half of the appropriate minimum freeboard determined in accordance with paragraph 5(4) or (5) of the Fifth Schedule—

Sixth Schedule.

Save that such freeboard shall not in either case be less than 150 millimetres.

**40.** Any ship in respect of which a Load Line Certificate has been issued under section 282 of the Act, shall, pursuant to section 303(2) of the Act, post up in some conspicuous place on board ship before the ship leaves any dock, wharf or harbour or other place for the purposes of proceeding to sea, a notice in the form set out in the Ninth Schedule and the notice shall contain the particulars required by that form and be signed by the master and an officer.

Depth of loading.

Ninth Schedule.

Special position of deck line and correction of freeboards.

**41.** (1) In any case in which the deck line is to be marked on the sides of a ship as required by regulation 23(3), the freeboards to be assigned to the ship shall be corrected to allow for the vertical distance by which the position of the deck-line is altered by virtue of that Regulation.

(2) The location of the point by reference to which the deck-line has been marked as required by regulation 23(3) and the identity of the deck which has been taken as the freeboard deck shall be specified in the Load Line Certificate issued in respect of the ship.

#### PART VII

### STABILITY, LOADING AND BALLASTING INFORMATION

Information as to the stability of ships.

**42.** (1) The owner of any ship to which freeboards are assigned under these Regulations shall provide, for the guidance of the master of the ship, information relating to the stability of the ship in accordance with subregulations (2) to (7).

(2) The information referred to in subregulation (1) shall include particulars appropriate to the ship in respect of all matters specified in the Seventh Schedule and shall be in the form required by that Schedule.

(3) Subject to subregulation (5) the information shall, when first supplied, be based on the determination of stability by means of an inclining test which shall, unless the Minister otherwise permits, be carried out in the presence of a surveyor appointed by the Assigning Authority and, where the Minister so directs, by a surveyor acting on behalf of the Maritime Services Division.

(4) The information first supplied in accordance with subregulation (3) shall be replaced by fresh information whenever its accuracy is materially affected by alterations to the ship and such fresh information shall, if the Minister so requires, be based on a further inclining test.

(5) The Minister may—

- (a) in the case of any ship, allow the information to be based on the determination, by means of an inclining test, of the stability of a sister ship;

(b) in the case of a ship specially designed for the carriage of liquids or ore in bulk, or of any class of such ships, dispense with an inclining test if satisfied from the information available in respect of similar ships that the ship's proportions and arrangements are such as to ensure more than sufficient stability in all probable loading conditions.

(6) The Information, and any fresh information to replace the same in accordance with subregulations (3) and (4) shall, before being issued to the master—

(a) be submitted in duplicate by or on behalf of the owner of the ship to the Assigning Authority, and where the Assigning Authority is not the Maritime Services Division an additional copy of the information, or any fresh information, shall be forwarded to the Director of Maritime Services;

(b) be approved by the Maritime Services Division or the Assigning Authority when the Minister so directs.

(7) Information supplied in accordance with subregulations (1) to (6) shall be furnished by the owner of the ship to the master in the form of a book which shall be kept on the ship at all times in the custody of the master.

**43.** (1) The owner of any ship to which freeboards are assigned under these Regulations, being a ship of more than 150 metres in length specially designed for the carriage of liquids or ore in bulk, shall provide for the information of the master, information relating to the loading and ballasting of the ship in accordance with subregulations (2) and (3).

Information as to loading and ballasting of ships.

(2) The information referred to in subregulation (1) shall consist of working instructions specifying in detail the manner in which the ship is to be loaded and ballasted so as to avoid the creation of unacceptable stresses in her structure and shall indicate the maximum stresses permissible for the ship.

(3) Regulation 42(6) shall have effect in respect of information required under this Regulation, and the information duly approved in accordance with that subregulation, shall be contained in the book to be furnished to the master of the ship pursuant to regulation 42(7), so however that the information to be provided pursuant to each regulation is separately shown in the book under separate headings specifying the number and heading of each.

## PART VIII

## RECOGNITION OF OTHER LOAD LINE CERTIFICATES

Recognition of  
Certificates  
issued by other  
Governments.

**44.** (1) Certificates which are issued as International Load Line Certificates (1966) in respect of Convention ships by Governments other than Trinidad and Tobago shall be recognised for the purposes of the Act where—

- (a) the certificate shows by its terms that it was issued in respect of the ship by—
  - (i) the Government of the Convention country in which the ship is registered or, if the ship is not registered in any such country or elsewhere, the Government of the Convention country whose flag she flies; or
  - (ii) the Government of any other Convention country stated in the certificate to have issued the certificate at the request of a country specified in subparagraph (i); or
  - (iii) by a person or organisation under the authority of a Government specified in subparagraph (i) or (ii);
- (b) the certificate is in the official language or languages of the issuing country and, if the language used is neither English nor French, includes in its text a translation into one of those languages;

- (c) the certificate is in the form set out in Annex III to the Load Line Convention for an International Load Line Certificate (1966) and contains all the particulars required by such form;
- (d) the certificate shows that it is currently in force and applicable to the voyage in respect of which clearance or transire is required;
- (e) the period for which the certificate is expressed to be valid does not exceed five years from the date of issue;
- (f) any extension of any period for which the certificate is expressed to be valid is duly endorsed on the certificate by the Issuing Authority and does not exceed five months;
- (g) periodical inspections of the ship to which the certificate relates, being inspections required by Article 14(1)(c) of the Load Line Convention, are shown duly endorsed on the certificate by the Issuing Authority; and
- (h) the ship to which the certificate relates—
  - (i) where registered in a Convention country when the certificate was issued, remains registered in that country; or
  - (ii) where not so registered when the certificate was issued, either has since been registered in the Convention country by or on behalf of the Government of which the Certificate was issued and remains so registered, or flies the flag of that Convention country.

(2) Subregulation (1) applies to exemption certificates issued in accordance with the Load Line Convention, in the same manner as it applies to International Load Line Certificates (1966) subject to the substitution for the reference in subregulation (1)(c) to an International Load Line Certificate (1966) of reference to an International Load Line Exemption Certificate.

**LAWS OF TRINIDAD AND TOBAGO**

MINISTRY OF THE ATTORNEY GENERAL AND LEGAL AFFAIRS

www.legalaffairs.gov.tt

486

**Chap. 50:10**

*Shipping*

**[Subsidiary]**

*Shipping (Load Line) Regulations*

Regulations 15  
and 20.

**FIRST SCHEDULE**

**FORMS OF CERTIFICATES**

**FORM 1**

**INTERNATIONAL LOAD LINE CERTIFICATE (1966)**

(Official Seal)

Issued under the provisions of the International Convention on Load Lines 1966, under the authority of the Government of:

THE REPUBLIC OF TRINIDAD AND TOBAGO

by .....  
*(full official designation of the Assigning Authority)*

Name of Ship	Distinctive Number or Letters	Port of Registry	Length (L) as defined in Article 2(8)	Gross Tonnage

\*Freeboard assigned as: A new ship, An existing ship.

†Type of Ship: Type A, Type B, Type B with reduced/increased freeboard/timber freeboard.

	<i>Freeboard from Deck-Line</i>			<i>Load Line</i>
Tropical	...	...	... mm (T)	... .. mm above (S)
Summer	...	...	...mm (S)	Upper edge of line through centre of ring
Winter	...	...	... mm (W)	... .. mm below (S)
Winter North Atlantic	...	...	mm (WNA)	... .. mm below (S)
Timber Tropical	...	...	... mm (LT)	... .. mm above (LS)
Timber Summer	...	...	... mm (LS)	... .. mm above (S)
Timber Winter	...	...	... mm (LW)	... .. mm below (LS)
Timber Winter North Atlantic	...	...	mm (LWNA)	... ..mm below (LS)

NOTE: Freeboards and Load Lines which are not applicable need not be entered on the certificate.

UNOFFICIAL VERSION

UPDATED TO 31ST DECEMBER 2016

Allowance for Fresh Water for all freeboards other than timber ..... mm.

Allowance for Fresh Water for Timber freeboards ..... mm.

The upper edge of the deck-line from which these freeboards are measured

is ..... mm .....

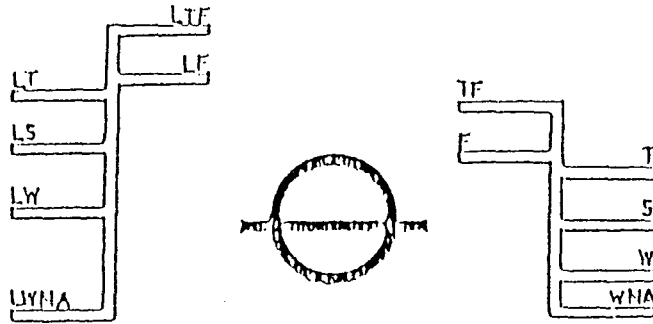

*Note: Applicable load lines to be indicated*

Date of initial or periodical survey .....

This is to certify that this ship has been surveyed and that the freeboards have been assigned and load lines shown above have been marked in accordance with the International Convention on Load Lines 1966.

This certificate is valid until ..... subject to periodical inspections in accordance with Article 14(1)(c) of the Convention.

Issued at ..... on ..... 20.....

The undersigned declares that  
† he is duly authorised

† ..... (specify Assigning Authority) are duly authorised by the said Government to issue this Certificate.

.....  
(Signature and designation)

NOTE:

1. When a ship departs from a port situated on a river or inland water, deeper loading shall be permitted corresponding to the weight of fuel and all other materials required for consumption between the point of departure and the sea.

LAWS OF TRINIDAD AND TOBAGO

MINISTRY OF THE ATTORNEY GENERAL AND LEGAL AFFAIRS

www.legalaffairs.gov.tt

488

Chap. 50:10

Shipping

[Subsidiary]

Shipping (Load Line) Regulations

2. When a ship is in fresh water of unit density the appropriate load line may be submerged by the amount of the fresh water allowance shown above. Where the density is other than unity an allowance shall be made proportional to the difference between 1.025 and the actual density.

\*Delete whichever is inapplicable.

†The first alternative is to be used if the Certificate is issued by the Maritime Services Division and the second where it is issued by an Assigning Authority other than the Division. Delete whichever is inapplicable.

This is to certify that at a periodical inspection required by Article 14(1)(c) of the Convention, this ship was found to comply with the relevant provisions of the Convention.

Place ..... Date .....

(Signature and designation) .....

on behalf of ..... (specify Assigning Authority)

Place ..... Date .....

(Signature and designation) .....

on behalf of ..... (specify Assigning Authority)

Place ..... Date .....

(Signature and designation) .....

on behalf of ..... (specify Assigning Authority)

Place ..... Date .....

(Signature and designation) .....

on behalf of ..... (specify Assigning Authority)

NOTE:

This Certificate must be kept framed and posted up in some conspicuous place on board the ship, so long as it remains in force and the ship is in use.

UNOFFICIAL VERSION

UPDATED TO 31ST DECEMBER 2016

FORM 2  
INTERNATIONAL LOAD LINE EXEMPTION  
CERTIFICATE

(Official Seal)

ISSUED under the provisions of the International Convention on Load Lines, 1966, under the authority of the Government of:

THE REPUBLIC OF TRINIDAD AND TOBAGO

by the Maritime Services Division

Name of Ship	Distinctive Number or Letters	Port of Registry

This is to certify that the above-mentioned ship is exempted from the provisions of the 1966 Convention, under the authority conferred by Article 6(2)/Article 6(4)\*

The provisions of the Convention from which the ship is exempted under Article 6(2) are:

.....  
.....  
.....

The voyage for which exemption is granted under Article 6(4) is:

From: .....

To: .....

Conditions, if any, on which the exemption is granted under either Article 6(2) or Article 6(4):

.....  
.....  
.....  
.....

\*Delete whichever is inapplicable.

LAWS OF TRINIDAD AND TOBAGO

MINISTRY OF THE ATTORNEY GENERAL AND LEGAL AFFAIRS

www.legalaffairs.gov.tt

490

Chap. 50:10

Shipping

[Subsidiary]

Shipping (Load Line) Regulations

.....  
.....  
This certificate is valid until ..... subject, where appropriate, to periodical inspections in accordance with Article 14(1)(c) of the Convention.

Issued at ..... on ..... 20.....  
The undersigned declares that he is duly authorised by the said Government to issue this certificate.

.....  
*Authorised officer of the  
Maritime Services Division*

This is to certify that this ship continues to comply with the conditions under which this exemption was granted.

Place ..... Date .....

..... Surveyor, Maritime Services Division

Place ..... Date .....

..... Surveyor, Maritime Services Division

Place ..... Date .....

..... Surveyor, Maritime Services Division

Place ..... Date .....

..... Surveyor, Maritime Services Division

This ship continues to comply with the conditions under which this exemption was granted, and the validity of this certificate is, in accordance with Article 19(4)(a) of the

Convention, extended until .....

Place ..... Date .....

.....  
*Authorised by the Maritime  
Services Division*

UNOFFICIAL VERSION

UPDATED TO 31ST DECEMBER 2016

**FORM 3**

**TRINIDAD AND TOBAGO LOAD LINE CERTIFICATE**

(Official Seal)

Issued \* by the Maritime Services Division/\* under the authority of the Minister; \* by .....  
*(full official designation of the Assigning Authority)*

Name of Ship	Distinctive Number or Letters	Port of Registry	Length ( L ) as defined by regulations under section 280 of the Shipping Act	Gross Tonnage

\*Freeboard assigned as: A new ship, An existing ship.

†Type of ship; Type A, Type B, Type B with reduced/increased freeboard.

	<i>Freeboard from Deck Line</i>	<i>Load Line</i>
Tropical	... mm (T)	... mm above (S)
Summer	... mm (S)	Upper edge of line through centre of ring
Winter	... mm (W)	... mm below (S)
Winter North Atlantic	... mm (WNA)	... mm below (S)

Allowance for fresh water for all freeboards .... mm.

The upper edge of the deck-line from which these freeboards are measured is ..... mm .....

This is to certify that this ship has been surveyed and the freeboards and load lines shown above have been assigned in accordance with the Shipping (Load Line) Regulations 1992.

LAWS OF TRINIDAD AND TOBAGO

MINISTRY OF THE ATTORNEY GENERAL AND LEGAL AFFAIRS

www.legalaffairs.gov.tt

492

Chap. 50:10

Shipping

[Subsidiary]

Shipping (Load Line) Regulations

This certificate is valid until ..... subject to periodical inspections in accordance with those Regulations.

Issued at ..... on ..... 20 .....

Signature and designation .....

on behalf of .....

(specify Assigning Authority)

NOTE:

1. When a ship departs from a port situated on a river or inland water, deeper loading shall be permitted corresponding to the weight of fuel and all other materials required for consumption between the point of departure and the sea.

2. When a ship is in fresh water of unit density the appropriate load line may be submerged by the amount of the fresh water allowance shown above. Where the density is other than unity an allowance shall be made proportional to the difference between 1.025 and the actual density.

\*Delete whichever is inapplicable.

This is to certify that at a periodical inspection required by the Shipping (Load Line) Regulations 1992 this ship was found to comply with the relevant provisions of the Regulations.

Place ..... Date .....

(Signature and designation) .....

on behalf of ..... (specify Assigning Authority)

Place ..... Date .....

(Signature and designation) .....

on behalf of ..... (specify Assigning Authority)

Place ..... Date .....

(Signature and designation) .....

on behalf of ..... (specify Assigning Authority)

UNOFFICIAL VERSION

UPDATED TO 31ST DECEMBER 2016

Survey of this ship having been satisfactorily completed in accordance with the requirements of the Shipping (Load Line) Regulations 20.....this certificate is extended until .....

Place ..... Date .....

(Signature and designation) .....

on behalf of ..... (specify Assigning Authority)

**NOTE:**

This Certificate must be kept framed and posted up in some conspicuous place on board the ship, so long as it remains in force and the ship is in use.

**FORM 4**

**TRINIDAD AND TOBAGO LOAD LINE EXEMPTION  
 CERTIFICATE**

(Official Seal)

Issued by the Maritime Services Division

Name of Ship	Distinctive Number or Letters	Port of Registry

This is to certify that the above-mentioned ship is exempted pursuant to section 287(2) of the Shipping Act from

\*All the provisions of that Act and of the Shipping (Load Line) Regulations, 1992.

\*The following provisions of that Act and of the Shipping (Load Line) Regulations, 1992.

.....  
 .....

Subject to the following conditions:

.....  
 .....  
 .....

\*Delete if inapplicable.

**LAWS OF TRINIDAD AND TOBAGO**

MINISTRY OF THE ATTORNEY GENERAL AND LEGAL AFFAIRS

www.legalaffairs.gov.tt

494

**Chap. 50:10**

*Shipping*

**[Subsidiary]**

*Shipping (Load Line) Regulations*

This certificate is valid until ..... subject where appropriate, to periodical inspections in accordance with the Shipping (Load Line) Regulations.

Issued at ..... on ..... 20.....

.....  
*An authorised officer of the Maritime Services Division*

This is to certify that this ship continues to comply with the conditions under which this exemption was granted—

Signed ..... Place ..... Date .....  
Surveyor, Maritime Services Division

Signed ..... Place ..... Date .....  
Surveyor, Maritime Services Division

Signed ..... Place ..... Date .....  
Surveyor, Maritime Services Division

Signed ..... Place ..... Date .....  
Surveyor, Maritime Services Division

\_\_\_\_\_

UNOFFICIAL VERSION

UPDATED TO 31ST DECEMBER 2016

**SECOND SCHEDULE**

Regulation 5.

**ZONES, AREAS AND SEASONAL PERIODS**

A. Northern Winter Seasonal Zones and Areas

1. (1) The North Atlantic Winter Seasonal Zones I and II and the related seasonal periods shall be as set out in subparagraphs (2) to (7).

(2) The North Atlantic Winter Seasonal Zone I lies within the meridian of longitude 50° 00' West from the coast of Greenland to latitude 45° 00' North, thence the parallel of latitude 45° 00' North to longitude 15° 00' West, thence the meridian of longitude 15° 00' West to latitude 60° 00' North, thence the parallel of latitude 60° 00' North to the Greenwich Meridian, thence this meridian northwards.

(3) The seasonal periods for the North Atlantic Seasonal Zone I are—

(a) Winter: 16th October to 15th April.

(b) Summer: 16th April to 15th October.

(4) The North Atlantic Winter Seasonal Zone II lies within the meridian of longitude 68° 30' West from the coast of the United States to latitude 40° 00' North thence the rhumb line to the point latitude 36° 00' North longitude 73° 00' West, thence the parallel of latitude 36° 00' North to longitude 25° 00' West and thence the rhumb line to Cape Torinana.

(5) Excluded from the North Atlantic Winter Seasonal Zone II are the North Atlantic Winter Seasonal Zone I, the North Atlantic Winter Seasonal Area and the Baltic Sea bounded by the parallel of latitude of the Skaw in the Skagerrak.

(6) The seasonal periods for the North Atlantic Winter Seasonal Zone II are—

(a) Winter: 1st November to 31st March.

(b) Summer: 1st April to 31st October.

(7) The Shetland Islands are to be considered as being on the boundary line between the North Atlantic Winter Seasonal Zones I and II.

2. (1) The North Atlantic Winter Seasonal Area and the related seasonal periods shall be as set out in subparagraphs (2) and (3).

(2) The boundary of the North Atlantic Winter Seasonal Area is the meridian of longitude 68° 30' West from the coast of the United States to latitude 40° 00' North, thence the rhumb line to the southernmost intersection of the meridian of longitude 61° 00' West with the coast of Canada and thence the East coasts of Canada and the United States.

(3) The seasonal periods for the North Atlantic Winter Seasonal Area are—

- (a) for ships over 100 metres in length—
  - (i) Winter: 16th December to 15th February.
  - (ii) Summer: 16th February to 15th December.
- (b) for ships over 100 metres or less in length—
  - (i) Winter: 1st November to 31st March.
  - (ii) Summer: 1st April to 31st October.

3. (1) The North Pacific Winter Seasonal Zone and the related Seasonal Periods shall be as set out in subparagraphs (2) and (3).

(2) The southern boundary of the North Pacific Winter Seasonal Zone is the parallel of latitude 50° 00' North from the East coast of the USSR to the West coast of Sakhalin, thence the West coast of Sakhalin to the southern extremity of Cape Kril'on thence the rhumb line to Wakkanai, Hokkaido, Japan, thence the East and South coasts of Hokkaido to longitude 145° 00' East, thence the meridian of longitude 145° 00' East to latitude 35° 00' North thence the parallel of latitude 35° 00' North to longitude 150° 00' West and thence the rhumb line to the southern extremity of Dall Island, Alaska.

(3) The seasonal periods for the North Pacific Winter Seasonal Zone are—

- (a) Winter: 16th October to 15th April.
- (b) Summer: 16th April to 15th October.

#### B. Southern Winter Seasonal Zone

4. (1) The Southern Winter Seasonal Zone and the related Seasonal Periods shall be as set out in subparagraphs (2), (3) and (4).

(2) The northern boundary of the Southern Winter Seasonal Zone is the rhumb line from the East coast of the American continent at Cape Tres Puntas to the point latitude 34° 00' South, longitude 50° 00' West, thence the parallel of latitude 34° 00' South to longitude 17° 00' East, thence the rhumb line to the point latitude 35° 10' South, longitude 20° 00' East, thence the rhumb line to the point latitude 34° 00' South, longitude 28° 00' East, thence the rhumb line to the point latitude 35° 30' South, longitude 118° 00' East, and thence the rhumb line to Cape Grim on the northwest coast of Tasmania; thence along the North and East coast of Tasmania to the southernmost point of Bruny Island, thence the rhumb line to Black Rock Point on Stewart Island, thence the rhumb line to the point latitude 47° 00' South, longitude 170° 00' East, thence the rhumb line to the point latitude 33° 00' South, longitude 170° 00' West and

thence the parallel of latitude 33° 00' South to the point latitude 33° 00' South, longitude 79° 00' West, thence the rhumb line to the point latitude 41° 00' South, longitude 75° 00' West, thence the rhumb line to Punta Corona lighthouse on Chiloe Island, Latitude 41° 47' South, longitude 73° 53' West, thence along the North, East and South coasts of Chiloe Island to the point latitude 43° 20' South, longitude 74° 20' West, and thence the meridian of longitude 74° 20' West to the parallel of latitude 45° 45' South, including the inner Zone of Chiloe channels from the meridian 74° 20' West to the East.

(3) The seasonal periods for the Southern Winter Seasonal Zone are—

(a) Winter: 16th April to 15th October.

(b) Summer: 16th October to 15th April.

(4) Valparaiso is to be considered as being on the boundary line of the Summer and Winter Seasonal Zones.

#### C. Tropical Zone

5. (1) The Tropical Zone shall be as set out in subparagraphs (2) to (7).

(2) The northern boundary of the Tropical Zone is the parallel of latitude 13° 00' North from the East coast of the American continent to longitude 60° 00' West, thence the rhumb line to the point latitude 10° 00' North, longitude 58° 00' West, thence the parallel of latitude 10° 00' North to the longitude 20° 00' West, thence the meridian of longitude 20° 00' West to latitude 30° 00' North and thence the parallel of latitude 30° 00' North to the West coast of Africa; from the East coast of Africa the parallel of latitude 8° 00' North to longitude 70° 00' East, thence the meridian of longitude 70° 00' East to latitude 13° 00' North, thence the parallel of latitude 13° 00' North to the West coast of India; thence the South coast of India to latitude 10° 30' North on the East coast of India, thence the rhumb line to the point latitude 9° 00' North, longitude 82° 00' East, thence the meridian of longitude 82° 00' East to latitude 8° 00' North, thence the parallel of latitude 8° 00' North to the West coast of Malaysia, thence the coast of South-East Asia to the East coast of Vietnam at latitude 10° 00' North, thence the parallel of latitude 10° 00' North to longitude 145° 00' East, thence the meridian of longitude 145° 00' East to latitude 13° 00' North and thence the parallel of latitude 13° 00' North to the West coast of the American continent.

(3) The Southern Boundary of the Tropical Zone is the rhumb line from the Port of Santos, Brazil, to the point where the meridian of longitude 40° 00' West intersects the Tropic of Capricorn; thence the Tropic of Capricorn to the West coast of Africa; from the East coast of Africa the parallel of latitude 20° 00' South to the West coast of Madagascar, thence the West and North coasts of Madagascar to longitude 50° 00' East, thence the meridian of longitude 50° 00' East to latitude 10° 00' South, thence the parallel of latitude 10° 00' South to

# LAWS OF TRINIDAD AND TOBAGO

MINISTRY OF THE ATTORNEY GENERAL AND LEGAL AFFAIRS

www.legalaffairs.gov.tt

498

**Chap. 50:10**

*Shipping*

[Subsidiary]

*Shipping (Load Line) Regulations*

longitude 98° 00' East, thence the rhumb line to Port Darwin, Australia, thence the coasts of Australia and Wessel Island eastwards to Cape Wessel, thence the parallel of latitude 11° 00' South to the West side of Cape York; from the East side of Cape York the parallel of latitude 11° 00' South to longitude 150° 00' West, thence the rhumb line to the point latitude 26° 00' South, longitude 75° 00' West, thence the rhumb line to the point latitude 32° 47' South, longitude 72° 00' West, and thence to the parallel of latitude 32° 47' South to the West coast of South America.

(4) The areas to be included in the Tropical Zone are as follows:

- (a) the Suez Canal, the Red Sea and the Gulf of Aden, from Port Said to the meridian of longitude 45° 00' East;
- (b) the Persian Gulf to the meridian of longitude 59° 00' East;
- (c) the area bounded by the parallel of latitude 22° 00' South from the East coast of Australia to the Great Barrier Reef, thence the Great Barrier Reef to latitude 11° 00' South. The northern boundary of the area is the southern boundary of the Tropical Zone.

(5) Aden and Berbera are to be considered as being on the boundary line of the Tropical Zone and the Seasonal Tropical Area.

(6) Saigon is to be considered as being on the boundary line of the Tropical Zone and the Seasonal Tropical Area.

(7) Valparaiso and Santos are to be considered as being on the boundary line of the Tropical and Summer Zones.

## D. Seasonal Tropical Areas

6. (1) The Seasonal Tropical Areas and related seasonal periods are as set out in subparagraphs (2) to (22).

(2) The Seasonal Tropical Area in the North Atlantic shall consist of an area bounded—

- (a) on the North by the rhumb line from Cape Catoche, Yucatan, to Cape San Antonio, Cuba, the North coast of Cuba to latitude 20° 00' North and thence the parallel of latitude 20° 00' North to longitude 20° 00' West;
- (b) on the West by the coast of the American continent;
- (c) on the South and East by the northern boundary of the Tropical Zone.

(3) The Seasonal Periods for the Tropical area in the North Atlantic are—

- (a) Tropical: 1st November to 15th July.
- (b) Summer: 16th July to 31st October.

UNOFFICIAL VERSION

UPDATED TO 31ST DECEMBER 2016

(4) The Seasonal Tropical Area in the Arabian Sea shall consist of an area bounded—

- (a) on the West by the coast of Africa, the meridian of longitude 45° 00' East in the Gulf of Aden, the coast of South Arabia and the meridian of longitude 59° 00' East in the Gulf of Oman;
- (b) on the North and East by the coasts of Pakistan and India;
- (c) on the South by the northern boundary of the Tropical Zone.

(5) The Seasonal Periods for the Tropical Area in the Arabian Sea Area are—

- (a) Tropical: 1st September to 31st May.
- (b) Summer: 1st June to 31st August.

(6) The Seasonal Tropical Area in the Bay of Bengal shall consist of the area of the Bay of Bengal lying northward of the northern boundary of the Tropical Zone.

(7) The Seasonal Periods for the Seasonal Tropical Area in the Bay of Bengal are—

- (a) Tropical: 1st December to 30th April.
- (b) Summer: 1st May to 30th November.

(8) The Seasonal Tropical Area 1 in the South Indian Ocean shall consist of an area bounded—

- (a) on the North and West by the southern boundary of the Tropical Zone and the east coast of Madagascar;
- (b) on the South by the parallel of latitude 20° 00' South;
- (c) on the East by the rhumb line from the point latitude 20° 00' South, longitude 50° 00' East, to the point latitude 15° 00' South, longitude 51° 30' East, and thence by the meridian of longitude 51° 30' East to latitude 10° 00' South.

(9) The Seasonal Periods for the Seasonal Tropical Area 1 in the South Indian Ocean are—

- (a) Tropical: 1st April to 30th November.
- (b) Summer: 1st December to 31st March.

(10) The Seasonal Tropical Area 2 in the South Indian Ocean shall consist of an area bounded—

- (a) on the North by the southern boundary of the Tropical Zone;
- (b) on the East by the coast of Australia;
- (c) on the South by the parallel of latitude 15° 00' South from longitude 51° 30' East, to longitude 114° 00' East and thence the meridian of longitude 114° 00' East to the coast of Australia;
- (d) on the West by the meridian of longitude 51° 30' East.

**LAWS OF TRINIDAD AND TOBAGO**

MINISTRY OF THE ATTORNEY GENERAL AND LEGAL AFFAIRS

www.legalaffairs.gov.tt

500

**Chap. 50:10**

*Shipping*

[Subsidiary]

*Shipping (Load Line) Regulations*

(11) The Seasonal Periods for the Seasonal Tropical Area 2 in the South Indian Ocean are—

- (a) Tropical: 1st May to 30th November.
- (b) Summer: 1st December to 30th April.

(12) The Seasonal Tropical Area in the China Sea shall consist of an area bounded—

- (a) on the West and North by the coasts of Vietnam and China from latitude 10° 00' North to Hong Kong;
- (b) on the East by the rhumb line from Hong Kong to the Port of Sual (Luzon Island) and the West coasts of the Islands of Luzon, Samar and Leyte to latitude 10° 00' North;
- (c) on the South by the parallel of latitude 10° 00' North.

(13) Hong Kong and Saul are to be considered as being on the boundary of the Seasonal Tropical Area and Summer Zone.

(14) The Seasonal Periods for the Seasonal Tropical Area in the China Sea are—

- (a) Tropical: 21st January to 20th April.
- (b) Summer: 1st May to 20th January.

(15) The Seasonal Tropical Area 1 in the North Pacific shall consist of an area bounded—

- (a) on the North by the parallel of latitude 25° 00' North;
- (b) on the West by the meridian of longitude 160° 00' East;
- (c) on the South by the parallel of latitude 13° 00' North;
- (d) on the East by the meridian of longitude 130° 00' West.

(16) The Seasonal Periods for the Seasonal Tropical Area 1 in the Northern Pacific are—

- (a) Tropical: 1st April to 31st October.
- (b) Summer: 1st November to 31st March.

(17) The Seasonal Tropical Area 2 in the North Pacific shall consist of an area bounded—

- (a) on the North and East by the West coast of the American continent;
- (b) on the West by the meridian of longitude 123° 00' West from the coast of the American continent to latitude 33° 00' North and by the rhumb line from the point latitude 33° 00' North, longitude 123° 00' West to the point latitude 13° 00' North, longitude 105° 00' West;
- (c) on the South by the parallel of latitude 13° 00' North.

UNOFFICIAL VERSION

UPDATED TO 31ST DECEMBER 2016

(18) The Seasonal Periods for the Seasonal Tropical Area 2 in the North Pacific are—

- (a) Tropical: 1st March to 30th June and 1st November to 30th November.
- (b) Summer: 1st July to 31st October and 1st December to 28th, 29th February.

(19) The Seasonal Tropical Area 1 in the South Pacific shall consist of the Gulf of Carpentaria south of latitude 11° 00' South.

(20) The Seasonal Periods for the Seasonal Tropical Area 1 in the South Pacific are—

- (a) Tropical: 1st April to 30th November.
- (b) Summer: 1st December to 31st March.

(21) The Seasonal Tropical Area 2 in the South Pacific shall consist of an area bounded—

- (a) on the North and East by the southern boundary of the Tropical Zone;
- (b) on the South by the Tropic of Capricorn from the East coast of Australia to longitude 150° 00' West, thence by the meridian of longitude 150° 00' West to latitude 20° 00' South and thence by the parallel of latitude 20° 00' South to the point where it intersects the southern boundary of the Tropical Zone;
- (c) on the West by the boundaries of the area within the Great Barrier Reef included in the Tropical Zone and by the East coast of Australia.

(22) The Seasonal Periods for the Seasonal Tropical Area 2 in the South Pacific are—

- (a) Tropical: 1st April to 30th November.
- (b) Summer: 1st December to 31st March.

#### E. Summer Zones

7. (1) The Summer Zones and related Seasonal Periods are as set out in subparagraphs (2) to (4).

(2) Subject to subparagraphs (3) and (4), the sea areas lying outside the Areas defined in paragraphs 1 to 7 inclusive shall constitute the Summer Zones.

(3) For ships of 100 metres or less in length, the area bounded—

- (a) on the North and West by the East coast of the United States;

**LAWS OF TRINIDAD AND TOBAGO**

MINISTRY OF THE ATTORNEY GENERAL AND LEGAL AFFAIRS

www.legalaffairs.gov.tt

502

**Chap. 50:10**

*Shipping*

[Subsidiary]

*Shipping (Load Line) Regulations*

(b) on the East by the meridian of longitude 68° 30' West from the coast of the United States to latitude 40° 00' North and thence by the rhumb line to the point latitude 36° 00' North longitude 73° 00' West;

(c) on the South by the parallel of latitude 36° 00' North,

is a Winter Seasonal Area.

(4) The Seasonal Periods for the Winter Seasonal Area defined in subparagraph (3) are—

(a) Winter: 1st November to 31st March.

(b) Summer: 1st April to 31st October.

**F. Enclosed Seas**

8. (1) The Enclosed Seas and related Seasonal Periods are to be dealt with as set out in subparagraphs (2) to (9).

(2) The area of the Baltic Sea bounded by the parallel of latitude of The Skaw in the Skagerrak is included in the Summer Zones; however, for ships of 100 metres or less in length, it is a Winter Seasonal Area.

(3) The Seasonal Periods for the Winter Seasonal Area defined in subparagraph (2) are—

(a) Winter: 1st November to 31st March.

(b) Summer: 1st April to 31st October.

(4) The Black Sea is included in the Summer Zones; however, for ships of 100 metres or less in length, the area north of latitude 44° 00' North is a Winter Seasonal Area.

(5) The Seasonal Periods for the Winter Seasonal Area defined in subparagraph (4) are—

(a) Winter: 1st December to 28th, 29th February.

(b) Summer: 1st March to 30th November.

(6) The Mediterranean Sea is included in the Summer Zones; however, for ships of 100 metres or less in length, the area bounded—

(a) on the North and West by the coasts of France and Spain and the meridian of longitude 3° 00' East from the coast of Spain to latitude 40° 00' North;

(b) on the South by the parallel of latitude 40° 00' North from longitude 3° 00' East to the West coast of Sardinia;

(c) on the East by the West and North coasts of Sardinia from latitude 40° 00' North to longitude 9° 00' East, thence by the meridian of longitude 9° 00' East to the South coast of Corsica, thence by the West and North coasts of Corsica to longitude 9° 00' East and thence by the rhumb line to Cape Sicié,

is a Winter Seasonal Area.

UNOFFICIAL VERSION

UPDATED TO 31ST DECEMBER 2016

(7) The Seasonal Periods for the Winter Seasonal Area defined in subparagraph (6) are—

- (a) Winter: 16th December to 15th March.
- (b) Summer: 16th March to 15th December.

(8) The Sea of Japan South of latitude 50° 00' North is included in the Summer Zones; however, for ships of 100 metres or less in length, the area between the parallel of latitude 50° 00' North and the rhumb line from the East coast of Korea at latitude 38° 00' North to the West coast of Hokkaido, Japan, at latitude 43° 12' North is a Winter Seasonal Area.

(9) The Seasonal Periods for the Winter Seasonal Area defined in subparagraph (8) are—

- (a) Winter: 1st December to 28th, 29th February.
- (b) Summer: 1st March to 30th November.

#### G. Ports on Boundary Lines

9. For the purposes of the application of this Schedule to a ship at a port which stands on the boundary line between two Zones or Areas or between a Zone and an Area, or which is required under this Schedule to be considered as being on such a boundary line, the port shall be deemed to be within the Zone or Area into which the ship is about to proceed or from which she has arrived as the case may be.

### THIRD SCHEDULE

Regulation 34.

#### RECORD OF PARTICULARS

The following is the form of record of particulars referred to in regulation 34:

##### RECORD 1

SHIPPING (LOAD LINE) REGULATIONS, 1992

#### RECORD OF PARTICULARS RELATING TO CONDITIONS OF ASSIGNMENT

In this record references to regulations are references to the regulations set out in Annex I to the International Convention on Load Lines, 1966, and references to paragraphs are references to paragraphs of the Fourth Schedule (Conditions of Assignment) to the Shipping (Load Line) Regulations, 1992.

**LAWS OF TRINIDAD AND TOBAGO**

MINISTRY OF THE ATTORNEY GENERAL AND LEGAL AFFAIRS

www.legalaffairs.gov.tt

504

**Chap. 50:10**

*Shipping*

[Subsidiary]

*Shipping (Load Line) Regulations*

Name of Ship .....

Port of registry .....

Nationality .....

Distinctive number or letters .....

Shipbuilders .....

Yard number .....

Date of build/conversion .....

Freeboards assigned as a ship of Type .....

Classification .....

Date and place of initial survey .....

**RECORD 2**

INTERNATIONAL CONVENTION ON LOAD LINES, 1966

**RECORD OF PARTICULARS RELATING TO  
CONDITIONS OF ASSIGNMENT**

In this record references to regulations are references to the regulations set out in Annex I to the International Convention on Load Lines, 1966.

Name of Ship .....

Port of registry .....

Nationality .....

Distinctive number or letters .....

Shipbuilders .....

Yard number .....

Date of build/conversion .....

Freeboards assigned as a ship of Type .....

Classification .....

Date and place of initial survey .....

UNOFFICIAL VERSION

UPDATED TO 31ST DECEMBER 2016

A PLAN OF SUITABLE SIZE MAY BE ATTACHED TO THIS REPORT IN PREFERENCE TO THE SKETCHES ON THIS PAGE

Disposition and dimensions of superstructures, trunks, deckhouses, machinery casings; extent of bulwarks, guard rails and wood sheathing on exposed deck to be inserted in the diagrams and tables following; together with positions of hatchways, gangways, and other means for the protection of the crew, cargo ports, bow and stern doors, side scuttles, scuppers, ventilators, air pipes, companionways, and other items that would affect the seaworthiness of the ship.

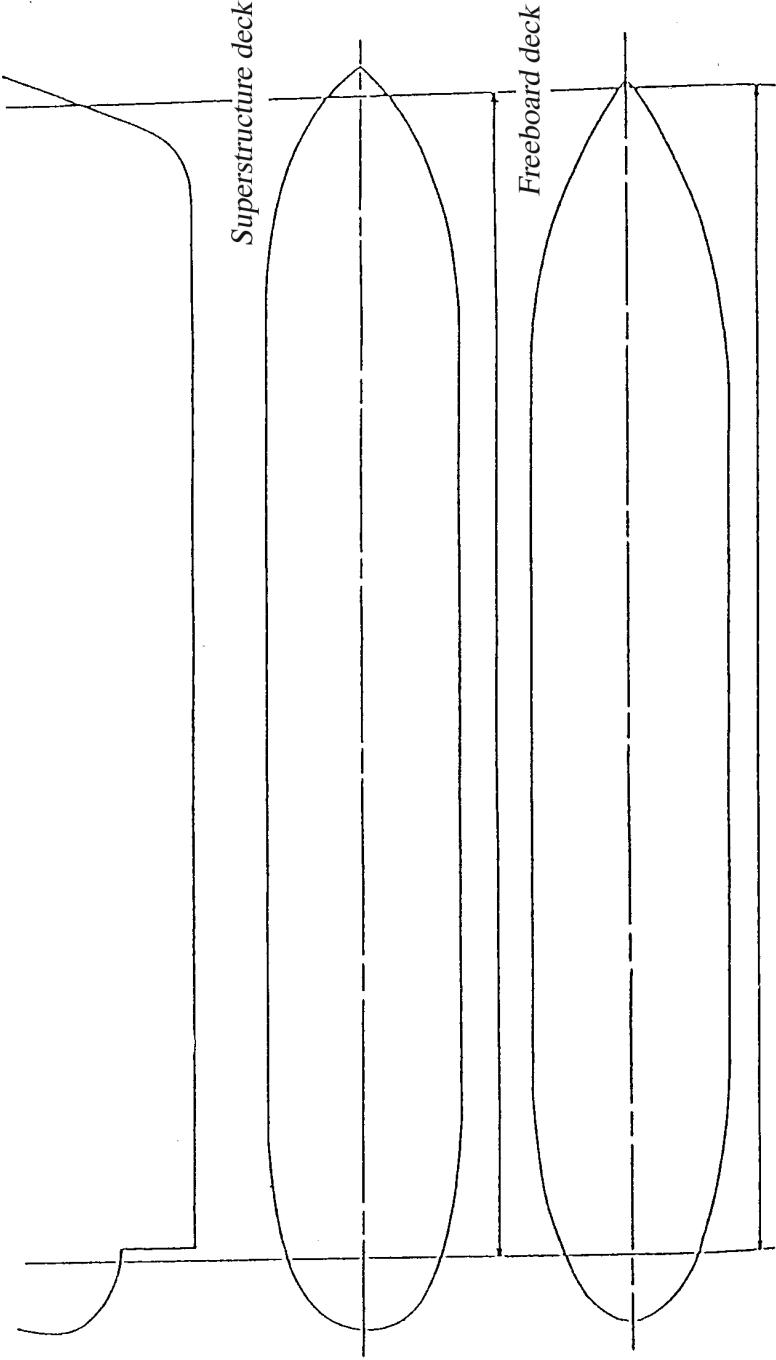

LAWS OF TRINIDAD AND TOBAGO

MINISTRY OF THE ATTORNEY GENERAL AND LEGAL AFFAIRS

www.legalaffairs.gov.tt

506

Chap. 50:10

Shipping

[Subsidiary]

Shipping (Load Line) Regulations

(FOURTH SCHEDULE PARAGRAPHS 7 AND 8)  
**DOORWAYS IN SUPERSTRUCTURES, EXPOSED MACHINERY CASINGS AND DECKHOUSES  
 PROTECTING OPENINGS IN FREEBOARD AND SUPERSTRUCTURE DECKS (REG. 12, 17 AND 18)**

Location	Ref. No. on Sketch of plan	Number and size of openings	Height of sills	Closing appliances	
				Type and material	Number of clips
In forecastle bulkhead					
In bridge forward bulkhead					
In bridge after bulkhead					
In raised quarter deck bulkhead					
In poop bulkhead					
In exposed machinery casings on freeboard or raised quarter decks					

UNOFFICIAL VERSION

UPDATED TO 31ST DECEMBER 2016

**DOORWAYS IN SUPERSTRUCTURES, EXPOSED MACHINERY CASINGS AND DECKHOUSES  
 PROTECTING OPENINGS IN FREEBOARD AND SUPERSTRUCTURE DECKS—Continued**

Location	Ref. No. on Sketch of plan	Number and size of openings	Height of sills	Closing appliances	
				Type and material	Number of clips
In exposed casings on superstructure decks					
In machinery casings within superstructures or deckhouses on freeboard deck					
In deckhouses in Position 1 enclosing openings leading below freeboard deck					
In deckhouses in Position 2 enclosing openings leading within enclosed superstructures or below freeboard deck					
In exposed pump room casings					

LAWS OF TRINIDAD AND TOBAGO

MINISTRY OF THE ATTORNEY GENERAL AND LEGAL AFFAIRS

www.legalaffairs.gov.tt

508

Chap. 50:10

Shipping

[Subsidiary]

Shipping (Load Line) Regulations

(FOURTH SCHEDULE PARAGRAPH 5)

HATCHWAYS AT POSITIONS 1 AND 2 CLOSED BY PORTABLE COVERS AND SECURED WEATHERTIGHT BY TARPAULINS AND BATTENING DEVICES (REG. 15)

Position and Reference No. on sketch or plan									
Dimensions of clear opening at top of coaming									
Height of coaming above deck									
PORTABLE BEAMS	Number								
Spacing									
$b_1 \times t_f$									
$D \times t_w$									
$b_2 \times t_f$									
Bearing surface									
Means of securing each beam									
PORTABLE COVERS	Material								
Thickness									
Direction fitted									
Bearing surface									
Spacing of cleats									
TARPAULINS	Number of layers								
Materials									

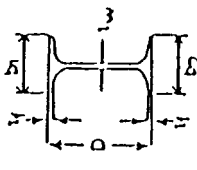

Are wood covers fitted with galvanised end bands?

UNOFFICIAL VERSION

UPDATED TO 31ST DECEMBER 2016

**(FOURTH SCHEDULE PARAGRAPHS 6 AND 19)**  
**HATCHWAYS AT POSITIONS 1 AND 2 CLOSED BY WEATHERTIGHT COVERS**  
**OF STEEL (OR OTHER EQUIVALENT MATERIAL) FITTED WITH GASKETS**  
**AND CLAMPING DEVICES (REG. 16)**

Position and Reference No. on sketch or plan						
Dimensions of clear opening at top of coaming						
Height of coaming above deck						
Type of cover or Patent Name						
Material						

Position and Reference No. on sketch or plan						
Dimension of clear opening at top of coaming						
Height of coaming above deck						
Type of cover or Patent Name						
Material						

**LAWS OF TRINIDAD AND TOBAGO**

MINISTRY OF THE ATTORNEY GENERAL AND LEGAL AFFAIRS

www.legalaffairs.gov.tt

510

**Chap. 50:10**

*Shipping*

[Subsidiary]

*Shipping (Load Line) Regulations*

**(FOURTH SCHEDULE PARAGRAPHS 7 AND 8)**  
**MACHINERY SPACE OPENINGS AND MISCELLANEOUS OPENINGS IN FREEBOARD AND SUPERSTRUCTURE DECKS (REGS. 17 AND 18)**

Position and Reference No. on sketch or plan							
Dimensions							
Height of coaming							
COVER {	Material						
	How attached						
Number and spacings of toggles							
Position and Reference No. on sketch or plan							
Dimensions							
Height of coaming							
COVER {	Material						
	How attached						
Number and spacings of toggles							
Particulars of spurting pipe closing arrangements:							

UNOFFICIAL VERSION

UPDATED TO 31ST DECEMBER 2016

**(FOURTH SCHEDULE PARAGRAPH 9)  
 VENTILATORS ON FREEBOARD AND SUPERSTRUCTURE DECKS  
 (POSITIONS 1 AND 2) (REG. 19)**

Deck on which fitted	Number fitted	Coaming		Type (State Patent Name if any)	Closing appliances
		Dimensions	Height		

**LAWS OF TRINIDAD AND TOBAGO**

MINISTRY OF THE ATTORNEY GENERAL AND LEGAL AFFAIRS

www.legalaffairs.gov.tt

512

**Chap. 50:10**

*Shipping*

[Subsidiary]

*Shipping (Load Line) Regulations*

**(FOURTH SCHEDULE PARAGRAPH 10)  
AIR PIPES ON FREEBOARD AND SUPERSTRUCTURE DECK (REG. 20)**

Deck on which fitted	Number fitted	Coaming		Type (State Patent Name if any)	Closing appliance
		Dimensions	Height		

UNOFFICIAL VERSION

UPDATED TO 31ST DECEMBER 2016

(FOURTH SCHEDULE PARAGRAPH 11)  
CARGO PORTS AND OTHER SIMILAR OPENINGS (REG. 21)

Position of port	Dimensions of opening	Distance of lower edge from freeboard deck	Securing devices	Remarks

(FOURTH SCHEDULE PARAGRAPH 12)  
SCUPPERS' INLET AND DISCHARGES (REG. 22)

State if scupper or discharge	Number	Pipe		From	Vertical distance above top of keel			Number, Type ‡ and Material † of Discharge valves	Position of con
		Diameter	Thick-ness		† Material	Discharge	Outlet in hull		

In Ro-Ro ships, indicate how ready accessibility to scupper valves is ensured when vehicle space is filled:

- S — Scupper † MS — Mild Steel
- D — Discharge † CS — Cast Steel
- GM — Gun Metal
- Any other approved material to be designated
- ‡ SD — Screw down
- ANR — Automatic non-return
- SDANB — Screw down automatic non-return

(FOURTH SCHEDULE PARAGRAPH 13)

SIDE SCUTTLES (REG. 23)

Position	Number fitted	Clear glass size	Fixed or opening	Material		Type of glass and thickness	Standards used and Type No.
				Frame	Deadlight		

Indicate the vertical distance between the freeboard deck and the lower sill of the side scuttle positioned at the greatest vertical distance below the freeboard deck.

(FOURTH SCHEDULE PARAGRAPHS 14 AND 20)

**FREEING PORTS (REG. 24)**

	Length of bulwark	Height of bulwark	Number and size of freeing ports each side	Total area each side	Required area each side
After well					
Freeboard deck					
Forward well					
Superstructure deck					

State fore and aft position of each freeing port in relation to superstructure end bulkheads

}

 After well  
 Forward well

Particulars of shutters, bars or rails fitted to freeing ports:

Heights of lower edge of freeing port above deck

**(FOURTH SCHEDULE PARAGRAPHS 15, 18, 22, 23 AND 24)**

**PROTECTION OF THE CREW (REGS. 25 AND 26)**

State particulars of bulwarks or guardrails on freeboard and superstructure decks:

State details of lifelines, walkways, gangways or underdeck passageways where required to be fitted:

**FOURTH SCHEDULE PARAGRAPH (REG. 29)**

**TIMBER DECK CARGO FITTINGS (REG. 44)**

State particulars of uprights, sockets, lashings, guardrails and lifelines:

**OTHER SPECIAL FEATURES**

**LAWS OF TRINIDAD AND TOBAGO**

MINISTRY OF THE ATTORNEY GENERAL AND LEGAL AFFAIRS

www.legalaffairs.gov.tt

518

**Chap. 50:10**

*Shipping*

[Subsidiary]

*Shipping (Load Line) Regulations*

**INITIAL SURVEY**

The conditions of assignment shown on this form are a record of the arrangements and fittings provided on the ship and are in accordance with the requirements of the relevant regulations set out in Annex 1 to the International Convention on Load Lines, 1996 and of these Regulations.

.....  
*Surveyor's Signature*

.....  
*Date*

**SUBSEQUENT PERIODICAL SURVEYS**

I have completed the periodical survey and am satisfied that the fittings and appliances are in accordance with the particulars shown in this record and are in good condition and that approved stability information and, where applicable, information relating to loading and ballasting of the ship is on board.

Signature	Port of Survey	Date of Survey
.....	.....	.....
.....	.....	.....
.....	.....	.....
.....	.....	.....
.....	.....	.....

UNOFFICIAL VERSION

UPDATED TO 31ST DECEMBER 2016

**FOURTH SCHEDULE**

Regulation 32.

**CONDITIONS OF ASSIGNMENT**

1. In this Schedule—

Interpretation.

“after perpendicular” means the perpendicular taken at the after end of the ship’s length (L);

“breadth” and the symbol (B) in relation to a ship means the maximum breadth of the ship measured amid ships to the moulded line of the frame in the case of a ship having a metal shell, or to the outer surface of the hull in the case of a ship having a shell of any other material;

“enclosed superstructure” means a superstructure—

- (a) which has enclosing bulkheads of efficient construction in which all access openings are fitted with sills and weathertight doors; and
- (b) in which all other openings in the sides or end thereof are fitted with efficient weathertight means of closing, but shall not include a bridge or poop fulfilling these requirements unless access is provided by which the crew can reach machinery and other working spaces within the bridge or poop by alternative means which are available for the purpose at all times when access openings in the bulkheads of the bridge or poop are closed;

“exposed position” means a position which is either—

- (a) exposed to weather and sea; or
- (b) within a structure so exposed other than an enclosed superstructure;

“forward perpendicular” means the perpendicular taken at the forward end of the ship’s length (L), coinciding with the fore-side of the stem on the waterline on which such length is measured;

“height” in relation to a superstructure means the least vertical height measured at the side from the top of the superstructure deck beams to the top of the freeboard deck beams;

“standard height” of a superstructure means the height ascertained in accordance with paragraph 9 of the Fifth Schedule;

“summer load waterline” in relation to a ship means the waterline which corresponds or will, when load lines have been marked on the sides of the ship, correspond to the summer load line of the ship;

“superstructure” means a decked structure, including a raised quarter-deck situated on the freeboard deck which either stands from side to side of the ship or is such that its side plating is not inboard of the shell plating of the

ship by more than four per cent of the breadth (B) of the ship; and, where the freeboard deck of the ship consists of a lower deck as described in item (b) of the definition of “freeboard deck” in regulation 2 includes that part of the hull of the ship which extends above the freeboard deck;

“superstructure deck” means a deck forming the top of a superstructure;

“Type ‘A’ Ship” means a ship which is designed to carry only liquid cargoes in bulk and has the characteristics set out as follows:

- (a) the cargo tanks of the ship have only small access openings closed by watertight gasketed covers of steel;
- (b) the ship in consequence of its design has high integrity of the exposed deck and has a high degree of safety against flooding in consequence of the low permeability of loaded cargo spaces and the degree of subdivision therein;
- (c) if over 150 metres in length and designed to have empty compartments when loaded to the Summer load waterline, the ship shall be capable of remaining afloat after the flooding of any one of such empty compartments, at an assumed permeability of 0.95, in the condition of equilibrium described in item (d) save that if the ship exceeds 225 metres in length its machinery space shall also be treated as one of the floodable compartments above-mentioned but with an assumed permeability of 0.85;
- (d) the condition of equilibrium referred to in item (c) is as follows:
  - (i) the final water line after the flooding specified in item (c) is below the top of any ventilator coaming, the lower edge of any pipe opening, the upper edge of the sill and any access opening fitted with a weather tight door, and the lower edge of any other opening through which progressive flooding may take place;
  - (ii) the angle of heel due to unsymmetrical flooding does not exceed 15 degrees;
  - (iii) the metacentric height calculated using the constant displacement method has a positive value of at least 50 millimetres in the upright condition after the flooding specified in item (c); and
  - (iv) the ship has adequate residual stability;

“Type ‘B’ Ship” means either—

- (a) a new ship other than a Type “A” ship; or
- (b) an existing ship which, being so constructed or modified as to comply with all the requirements of this Schedule applicable to a new ship of her type is to be assigned freeboards determined in accordance with the Fifth Schedule;

“weathertight” in relation to any part of a ship other than a door in a bulkhead means that the part is such that water will not penetrate it and so enter the hull of the ship in the worst sea and weather conditions likely to be encountered by the ship in service; and in relation to a door in a bulkhead means a door which—

- (a) is constructed of steel or other equivalent material, is permanently and strongly attached to the bulkhead and is framed, stiffened and fitted so that the whole structure in which it is set is of equivalent strength to the unpierced bulkhead;
- (b) is closed by means of gaskets, clamping devices or other equivalent means permanently attached to the bulkhead or to the door itself;
- (c) when closed, is weathertight as above defined; and
- (d) is so arranged that it can be operated from either side of the bulkhead.

Reference to any structure, opening or fitting as being in Position 1 and Position 2 shall be construed as references to its being in the following positions respectively:

Position 1:

- (a) on an exposed freeboard deck;
- (b) on a raised quarter deck; or
- (c) on an exposed superstructure deck situated forward of a point located one quarter of the ship’s length (L) from the forward perpendicular;

Position 2:

on an exposed superstructure deck situated abaft one quarter of the ship’s length (L) from the forward perpendicular.

#### PART I

### SHIPS IN GENERAL

2. (1) The construction of the ship shall be such that her general structural strength will be sufficient for the freeboards to be assigned to her. Structural strength and stability.

(2) The design and construction of the ship shall be such as to ensure that her stability in all probable loading conditions will be sufficient for the freeboards to be assigned to her, and for this purpose regard shall be had, in addition to the intended service of the ship and to any relevant requirements or Regulations made under the Shipping Act, to the stability and methods of the calculation of the criteria laid down in the Seventh Schedule.

LAWS OF TRINIDAD AND TOBAGO

MINISTRY OF THE ATTORNEY GENERAL AND LEGAL AFFAIRS

www.legalaffairs.gov.tt

522

Chap. 50:10

Shipping

[Subsidiary]

Shipping (Load Line) Regulations

(3) To determine whether the ship complies with the requirements of subparagraph (2), the ship shall, unless the Minister otherwise permits, be subjected to an inclining test.

(4) Where an inclining test is conducted in accordance with subparagraph (3) such test shall be witnessed by a Surveyor appointed by the Assigning Authority and where, the Minister so directs, by a Surveyor acting on behalf of the Maritime Services Division.

Superstructure  
end bulkheads.

3. Bulkheads at exposed ends of enclosed superstructures shall be of efficient construction and the height of any sill in an access opening in such a bulkhead shall, except where otherwise stated, be at least 380 millimetres above the deck.

Hatchways:  
General.

4. (1) The provisions of this paragraph and of paragraphs 5 and 6 apply to all hatchways in Position 1 or in Position 2 except where otherwise stated.

(2) Subject to subparagraph (3), the construction and the means for securing the weathertightness of a hatchway shall—

- (a) in the case of a hatchway closed by a portable cover and secured weathertight by tarpaulins and battening devices, comply with the requirements of paragraph 5; and
- (b) in the case of a hatchway closed by a weathertight cover of steel or other equivalent material fitted with gaskets and clamping devices, comply with the requirements of paragraph 6.

(3) Every hatchway in an exposed position on a deck above a superstructure deck and leading to a space below that superstructure deck shall be of such construction and be fitted with such means for securing the weathertightness of the hatchway as are adequate having regard to its position.

Hatchways  
closed by  
portable covers  
and secured  
weathertight by  
tarpaulins and  
battening  
devices.

5. (1) Coamings:

Every hatchway shall have a coaming of substantial construction. The coaming shall be constructed of mild steel but may be constructed of other material where the strength and stiffness of the coaming are equivalent to those of a coaming of mild steel. The height of the coaming above the deck shall be at least—

- (a) 600 millimetres if the hatchway is in Position 1;
- (b) 450 millimetres if the hatchway is in Position 2.

(2) Covers:

- (a) The width of every bearing surface for a hatchway cover shall be at least 65 millimetres;

UNOFFICIAL VERSION

UPDATED TO 31ST DECEMBER 2016

- (b) in the case of a cover made of wood—
  - (i) the finished thickness of the cover shall be at least 60 millimetres in association with a span of not more than 1.5 metres, and the thickness of covers for larger spans shall be increased in the ratio of 60 millimetres to a span of 1.5 metres;
  - (ii) the ends of the cover shall be protected by galvanised steel bands efficiently secured;
- (c) In the case of a cover made of mild steel—
  - (i) the strength of the cover shall be calculated with an assumed load ascertained in accordance with the following table and the product of the maximum stress thus calculated and the factor 4.25 shall not exceed the minimum ultimate strength of the material;
  - (ii) the cover shall be so designed as to limit the deflection to not more than 0.0028 times the span under the load appropriate to the hatchway cover under sub item (i);

**TABLE**

Ship's Length (L)	Assumed Load, per square metre	
	Hatchway in Position 1	Hatchway in Position 2
24 metres	1 metric ton	.75 metric tons
100 metres and over	1.75 metric tons	1.30 metric tons

over 24 metres but less than 100 metres to be ascertained by linear interpolation

- (d) in the case of a cover made neither of mild steel nor wood the strength and stiffness of the cover shall be equivalent to those of a cover of mild steel.
- (3) Portable beams shall be as follows:
- (a) where portable beams for supporting hatchway covers are made of mild steel, the strength of such beams shall be calculated with the appropriate assumed load ascertained in accordance with the Table in subparagraph (2) and the product of the maximum stress thus calculated and the factor 5 shall not exceed the minimum ultimate strength of the material;

- (b) such beams shall be so designed as to limit the deflection to not more than 0.0022 times the span under the load appropriate to the beam under item (a);
  - (c) in the case of portable beams not made of mild steel, the strength and stiffness of the beams shall be equivalent to those of beams of mild steel.
- (4) Pontoon covers shall be as follows:
- (a) where pontoon covers of mild steel are used in place of portable beams and covers, their strength shall be calculated with the appropriate assumed load ascertained in accordance with the Table in subparagraph (2) and the product of the maximum stress thus calculated and the factor 5 shall not exceed the minimum ultimate strength of the material;
  - (b) such pontoon covers shall be so designed as to limit the deflection to not more than 0.0022 times the span under the load appropriate to a pontoon cover under item (a);
  - (c) mild steel plating forming the tops of such covers shall be not less in thickness than 1 per cent of the spacing of the stiffness or 6 millimetres, whichever is the greater;
  - (d) in the case of pontoon covers not made of mild steel, the strength and stiffness of the cover shall be equivalent to those of a cover of mild steel.

(5) Carriers or sockets:

Carriers or sockets for portable beams shall be of substantial construction and shall provide efficient means for the fitting and securing of the beams; where rolling types of beams are used the arrangement shall ensure that the beams remain properly in position when the hatchway is closed.

(6) Cleats:

Cleats shall be set to fit the taper of the wedges; they shall be at least 65 millimetres wide and spaced not more than 600 millimetres centre to centre; the end cleats along each side or end of the hatchway shall be not more than 150 millimetres from the hatch corners.

(7) Battens and Wedges:

Battens and wedges shall be efficient for their purpose and in good condition wedges shall be of tough wood or equivalent material cut to a taper of not more than 1 in 6 and shall be not less than 13 millimetres thick at the toes.

(8) Tarpaulins:

At least two layers of tarpaulins shall be provided for every hatchway; such tarpaulins shall be waterproof, in good condition, and of materials of satisfactory strength and quality.

- (9) Security of hatchway covers shall be as follows:
- (a) except as otherwise provided in item (b), steel bars shall be provided for every hatchway sufficient to ensure that each section of hatchway covers can be sufficiently and independently secured after the tarpaulins have been battened down and that hatchway covers more than 1.5 metres in length are so secured by at least two such bars;
  - (b) bars of materials other than steel, or means of securing hatchway covers otherwise than by bars, may be so used, where—
    - (i) in the case of the former, the strength and stiffness of the bars used are equivalent to those of steel bars;
    - (ii) in either case the degree of security so achieved is not less than that which would be achieved by the use of steel bars.

6. (1) Coaming shall be as follows:

- (a) except as otherwise provided in item (b), every hatchway shall have a coaming of substantial construction the height of which above the deck shall be at least—
  - (i) 600 millimetres if the hatchway is in Position 1;
  - (ii) 450 millimetres if the hatchway is in Position 2;
- (b) a hatchway may have a coaming of less than the height applicable under the provisions of item (a), or in exceptional circumstances a coaming may be dispensed with, where—
  - (i) the safety of the ship will not be impaired in consequence in the worst sea and weather conditions likely to be encountered by the ship in service; and
  - (ii) any coaming fitted pursuant to this subparagraph is of substantial construction.

Hatchways closed by weathertight covers of steel or equivalent material fitted with gaskets and clamping devices.

(2) Weathertight Covers shall be as follows:

- (a) the strength of every cover of mild steel shall be calculated with an assumed load ascertained in accordance with the Table set out in paragraph 5(2) and the product of the maximum stress thus calculated and the factor 4.25 shall not exceed the minimum ultimate strength of the material. Every such cover shall be so designed as to limit the deflection under such a load to not more than 0.0028 times the span;
- (b) every cover constructed of material other than mild steel shall have strength and stiffness equivalent to those required in the case of a cover of mild steel;
- (c) every cover shall be fitted with efficient means by which it can be secured and made weathertight;

LAWS OF TRINIDAD AND TOBAGO

MINISTRY OF THE ATTORNEY GENERAL AND LEGAL AFFAIRS

www.legalaffairs.gov.tt

526

Chap. 50:10

Shipping

[Subsidiary]

Shipping (Load Line) Regulations

- (d) mild steel plating forming the top of any cover shall be not less in thickness than one per cent of the spacing of the stiffeners or 6 millimetres whichever is the greater.

Machinery  
space openings.

7. (1) Every machinery space opening situated in Position 1 or Position 2 shall be efficiently framed and enclosed by a steel casing of substantial strength, account being taken of the extent, if any, to which the casing is protected by other structures.

(2) Every doorway in a casing referred to in subparagraph (1) shall be fitted with a steel weathertight door having a sill the height of which shall be at least—

- (a) 600 millimetres above the deck if the opening is in Position 1;  
(b) 380 millimetres above the deck if the opening is in Position 2.

(3) Every opening in such a casing, other than a doorway, shall be fitted with a permanently attached cover of steel which is fitted with efficient means by which it can be secured and maintained weathertight and, except in the case of a cover consisting of a plate secured by bolts, is capable of being operated from either side of the opening.

(4) Every fiddley, funnel or machinery space ventilator situated in an exposed position on the freeboard deck or on a superstructure deck shall have a coaming of such height above the deck as will provide adequate protection having regard to its position.

Miscellaneous  
openings in  
freeboard and  
superstructure  
decks.

8. (1) Every manhole and flush scuttle in Position 1 or Position 2 shall be provided with a substantial cover fitted with efficient means by which it can be secured and maintained watertight and unless secured by closely spaced bolts, every such cover shall be permanently attached by a chain or equivalent means so as to be available for immediate use at all times.

(2) Every opening in a deck other than a hatchway, machinery space opening, manhole or flush scuttle shall—

- (a) if situated in the freeboard deck be protected either by an enclosed superstructure or by a deckhouse or companionway equivalent in strength and weather tightness to an enclosed superstructure;
- (b) if situated in an exposed position either—
- (i) in a deck over an enclosed superstructure and giving access to space within that superstructure; or
- (ii) on top of a deck house on the freeboard deck and giving access to space below that deck, be protected by an efficient deckhouse or companionway fitted with weathertight doors;

UNOFFICIAL VERSION

UPDATED TO 31ST DECEMBER 2016

- (c) if situated in an exposed position in a deck above the deck over an enclosed superstructure and giving access to space within that superstructure, be protected either in accordance with the requirements of item (b) or to such lesser extent as may be adequate having regard to its position.

(3) Every door in a companionway, deckhouse or enclosed superstructure referred to in subparagraph (2)(a) or (b) shall have a sill the height of which shall be at least—

- (a) 600 millimetres if the structure is in Position 1;
- (b) 380 millimetres if the structure is in Position 2.

9. (1) Except as otherwise provided in subparagraph (2) every ventilator in Position 1 or Position 2 leading to a space below the freeboard deck or below the deck of an enclosed superstructure shall have a coaming of steel or equivalent material, substantially constructed and efficiently connected to the deck and the height of such coamings shall be at least—

- (a) 900 millimetres above the deck if the ventilator is in Position 1;
- (b) 760 millimetres above the deck if the ventilator is in Position 2.

(2) Where the coaming for any ventilator referred to in subparagraph (1) is situated in a position in which it will be particularly subjected to weather and sea the height of the coaming shall exceed the relevant minimum height above specified by such amount as is necessary to provide adequate protection having regard to its position.

(3) Where the coaming of any ventilator referred to in subparagraphs (1) and (2) exceeds 900 millimetres in height above the deck it shall be efficiently supported by stays, brackets or other means.

(4) Every ventilator in Position 1 or Position 2 which passes through a superstructure other than an enclosed superstructure shall have a coaming of steel or equivalent material at the freeboard deck, substantially constructed and efficiently connected to that deck and at least 900 millimetres in height above that deck.

(5) Subject to subparagraphs (6) and (7), every ventilator opening in Position 1 or Position 2 shall be provided with an efficient appliance by which it can be closed and secured weathertight and every such closing appliance so provided on board a ship of not more than 100 metres in length shall be permanently attached to, and in the case of any other ship shall either be so attached or be conveniently stowed near to, the ventilator for which it is provided.

(6) A ventilator in Position 1 the coaming of which exceeds 4.5 metres in height above the deck, and a ventilator in Position 2 the coaming of which exceeds 2.3 metres in height above the deck, need not be fitted with a closing appliance unless either—

- (a) it serves the machinery spaces or a cargo compartment; or
- (b) the fitting of such an appliance is necessary in the circumstances in order to provide adequate protection.

LAWS OF TRINIDAD AND TOBAGO

MINISTRY OF THE ATTORNEY GENERAL AND LEGAL AFFAIRS

www.legalaffairs.gov.tt

528

Chap. 50:10

Shipping

[Subsidiary]

Shipping (Load Line) Regulations

(7) A ventilator in Position 1 or Position 2 leading to space in a battery room shall not be fitted with a closing appliance.

Air pipes.

10. (1) The exposed parts of any air pipe leading to a ballast or other tank and extending above the freeboard deck or a superstructure deck shall be of substantial construction.

(2) The exposed opening of any such air pipe shall be fitted with efficient means of closing the opening weathertight, which shall be permanently attached in a position ready for immediate use.

(3) Subject to subparagraph (4), the height above deck of the exposed opening of any such airpipe shall be—

- (a) at least 760 millimetres if that deck is the freeboard deck;
- (b) if that deck is a superstructure deck, at least 450 millimetres or, if the superstructure is of less than standard height, such greater height as is necessary to provide adequate protection having regard to the lower height of the superstructure.

(4) The height described in subparagraph (3) may in any particular case be lower than the minimum specified in relation thereto in that subparagraph if—

- (a) the working of the ship would be unreasonably interfered with if such minimum heights were adhered to; and
- (b) the closing arrangements are such as to ensure that such lower height is adequate in the circumstances.

Cargo ports and similar openings.

11. (1) Cargo ports and similar openings in the ship's side below the freeboard deck or in the sides or ends of superstructures which form part of the shell of the ship shall be compatible with the design of the ship and shall not exceed in number those necessary for the proper working of the ship.

(2) Every such cargo port and opening shall be provided with a door or doors so fitted and designed as to ensure watertightness and structural integrity commensurate with the surrounding shell plating.

(3) No such cargo port or opening below the freeboard deck shall, unless the Minister otherwise consents, be so situated that when load lines have been marked on the ship's side the lower edge of the port or opening will be below a line drawn parallel to the freeboard deck at side having as its lowest point the upper edge of the uppermost load line.

Scuppers, inlets and discharges.

12. (1) Every discharge led through the shell of a ship either—

- (a) from spaces below the freeboard deck; or
- (b) from within any enclosed superstructure or from within any deckhouse on the freeboard deck which is fitted with weathertight doors, shall be fitted in accordance with subparagraphs (2), (3) and (4) with efficient means for preventing water from passing inboard.

UNOFFICIAL VERSION

UPDATED TO 31ST DECEMBER 2016

(2) Subject to subparagraphs (3) and (4) the means referred to in subparagraph (1) shall consist of a single automatic non-return valve fitted at the shell of the ship and having positive means of closure from a position or positions above the freeboard deck, and such position or positions shall be readily accessible at all times under service conditions and shall be provided with an indicator showing whether the valve is open or closed.

(3) When load lines are marked on the ship, the inboard end of a discharge pipe is situated more than 0.01 (L) vertically above the Summer load waterline, then that discharge pipe's means of closing may consist of two automatic non-return valves having no positive means of closure, one of which shall be situated as close to the ship's shell as practicable and shall be substantially connected thereto and the inboard one of which is so situated that it shall at all times under service conditions be readily accessible for examination.

(4) Where the vertical distance referred to in subparagraph (3) exceeds 0.02 (L) the discharge pipe's means of closing may consist of a single automatic non-return valve having no positive means of closure, situated as close to the ship's shell as practicable and substantially connected thereto where, taking into account all the relevant circumstances, the arrangement provides adequate protection.

(5) The controls of any valve situated in a manned machinery space, and serving a main or auxiliary sea inlet or discharge or bilge injection system shall be so sited as to be readily accessible at all times under service conditions and valves referred to in this subparagraph and subparagraph (6) shall be equipped with an indicator showing whether the valve is open or closed.

(6) The controls of any valve situated in an unattended machinery space and serving a sea inlet or discharge or bilge injection system shall be so sited as to be readily accessible at all times under service conditions, particular attention being paid in this regard to possible delay in reaching or operating the controls and in addition, the machinery space in which the valve is situated shall be equipped with an efficient warning device to give warning at suitable control positions of any entry of water into the machinery space other than water resulting from the normal operation of the machinery.

(7) In this paragraph "unattended machinery space" means a machinery space which, during the normal operation of the ship at sea, is unmanned for any period, and "manned machinery space" means a machinery space other than an unattended machinery space.

(8) Every scupper and discharge pipe originating at any level and penetrating the shell of the ship either—

- (a) more than 450 millimetres below the freeboard deck; or
- (b) less than 600 millimetres above the Summer load waterline, shall be equipped with an automatic non-return valve situated as close to the ship's shell as practicable and substantially connected thereto.

LAWS OF TRINIDAD AND TOBAGO

MINISTRY OF THE ATTORNEY GENERAL AND LEGAL AFFAIRS

www.legalaffairs.gov.tt

530

Chap. 50:10

Shipping

[Subsidiary]

Shipping (Load Line) Regulations

- (9) Subparagraph (8) shall not apply—
- (a) where the scupper or discharge pipe is fitted with means for preventing water from passing inboard in accordance with subparagraphs (1) to (4); or
  - (b) in any case in which the piping of the scupper or discharge pipe is of substantial thickness.

(10) Every scupper leading from a superstructure other than an enclosed superstructure or from a deckhouse not fitted with weathertight doors shall be led overboard.

(11) All shell fittings and the valves required by the provisions of this paragraph shall be of steel, bronze or other suitable ductile material, and all pipes referred to in this paragraph shall be of steel or equivalent material.

Side scuttles.

13. (1) Every side scuttle to space below the freeboard deck or to space within an enclosed superstructure shall be fitted with a hinged inside deadlight by which it can be effectively closed and secured watertight.

(2) No side scuttle shall be fitted in a position such that its sill, when load lines have been marked on the ship's side, will be below a line drawn parallel to the freeboard deck at side having as its lowest point—

- (a) 2.5 per cent of the breadth of the ship (B) above the Summer load line; or
- (b) 500 millimetres above the Summer load line; whichever is the greater.

(3) Every side scuttle, deadlight, and glass, if fitted shall be of substantial construction and shall be efficiently fitted.

Freeing ports and arrangements.

14. (1) Where bulwarks on the weather portions of the freeboard deck, on a raised quarterdeck or on a superstructure deck form wells, efficient provision shall be made for rapidly freeing the decks of water in bulk and for draining them.

(2) Except as otherwise provided in subparagraphs (4) and (5), the sum of the areas of the openings of freeing ports on each side of the ship for each well, hereafter referred to in this paragraph as “the freeing port area” and by the symbol “(A)” shall—

- (a) if the well is on the freeboard deck or on a raised quarterdeck, be not less than the area ascertained in accordance with the formula and provisions given in subparagraph (3); and
- (b) if the well is on a superstructure deck other than a raised quarter deck be not less than one half of that area.

(3) The formula referred to in subparagraph (2)(a) is—

- (a) where the length (1) of a bulwark forming a well is 20 metres or less— $(A) = 0.7 + 0.035 (1)$  square metres;

UNOFFICIAL VERSION

UPDATED TO 31ST DECEMBER 2016

- (b) where the length (1) of a bulwark forming a well exceeds 20 metres;
  - (c) (A) = 0.07 (1) square metres; in no case need (1) be taken as being greater than 0.7 (1);
  - (d) where the bulwark is more than 1.2 metres in average height the required area shall be increased by 0.004 square metres per metre of length of well for each 0.1 metre difference in height;
  - (e) where the bulwark is less than 0.9 metre in average height, the required area may be decreased by 0.004 square metre per metre of length of well for each 0.1 metre difference in height.
- (4) With regard to sheer—
- (a) where the deck on which the well is situated has no sheer, the area (A) shall be the area ascertained in accordance with subparagraph (2) increased by 50 per cent;
  - (b) where the deck on which the well is situated has sheer less than standard sheer, the area (A) shall be the area ascertained in accordance with subparagraph (2) increased by a percentage to be obtained by linear interpolation;
  - (c) where the deck on which the well is situated has sheer, two thirds of the freeing port area (A) shall be situated in the half of the well which is nearest to the lowest point of the sheer.

(5) Where a ship fitted with a trunk which does not comply with the requirements of Regulation 36(1)(e) or where continuous or substantially continuous hatchway side coamings are fitted between detached superstructures the minimum area of the freeing port openings shall be calculated from the following Table:

Breadth of Hatchway or Trunk in Relation to the Breadth of Ship	Area of Freeing Ports in Relation to the Total Area of the Bulwark
40% or less	20%
75% or more	10%

(6) The area of freeing ports at intermediate breadths shall be obtained by linear interpolation.

(7) The lower edge of every freeing port shall be as near to the deck as practicable.

(8) Every freeing port more than 230 millimetres in depth shall be protected by rails or bars so fixed that the distance between the lowest rail or bar and the lower edge of the freeing port does not exceed 230 millimetres.

**LAWS OF TRINIDAD AND TOBAGO**

MINISTRY OF THE ATTORNEY GENERAL AND LEGAL AFFAIRS

www.legalaffairs.gov.tt

532

**Chap. 50:10**

*Shipping*

**[Subsidiary]**

*Shipping (Load Line) Regulations*

(9) Every freeing port which is fitted with a shutter shall have sufficient clearance to prevent jamming of the shutter, and the shutter hinges shall have pins or bearings of efficient non-corrodible material.

(10) Efficient provision shall be made for freeing from water any superstructure other than an enclosed superstructure.

Protection of the crew.

15. (1) Every deckhouse used for the accommodation of members of the crew shall be of efficient construction.

(2) Except as otherwise provided in subparagraph (3), all exposed parts of the freeboard deck and of every superstructure deck shall be fitted at their perimeter either with efficient guard rails or guard wires and stanchions complying with the requirements of subparagraph (4) or with bulwarks, being in either case at least 1 metre in height from the deck at side.

(3) The height specified in relation to guard rails or guard wires and bulwarks in subparagraph (2) may be reduced at any particular point if—

- (a) the working of the ship would be unreasonably interfered with if such minimum height were adhered to at that point; and
- (b) adequate protection is provided at that point.

(4) Guard rails or guard wires fitted pursuant to subparagraph (2) shall consist of courses of rails or wires supported by stanchions efficiently secured to the deck and the opening between the lowest course of the rails or wires and the deck shall not exceed 230 millimetres in height, and no opening above that course of rails or wires shall exceed 380 millimetres in height; where the ship has rounded gunwales, the stanchions shall be secured at the perimeter of the flat of the deck.

(5) Gangways, underdeck passages and all other means of access by which members of the crew pass between their quarters, the machinery space and any other space in the ship used by them in the course of their necessary work about the ship shall be so designed and constructed, and be fitted where necessary with such life lines, access ladders, guard rails or guard wires, hand rails or other safety fittings, as to afford effective protection for the crew.

(6) The requirements of this paragraph shall not apply in the case of unmanned barges.

**PART II**

**SPECIAL REQUIREMENTS APPLICABLE TO  
TYPE “A” SHIPS**

Application.

16. The requirements of paragraphs 17 to 20 of this Part apply in the case of Type “A” ships only.

Machinery casing.

17. (1) Except as provided in subparagraph (2) every casing enclosing a machinery space opening in Position 1 or Position 2 shall be protected by either—

- (a) an enclosed poop or bridge of at least standard height; or

UNOFFICIAL VERSION

UPDATED TO 31ST DECEMBER 2016

(b) a deckhouse of equal height and equivalent strength and weathertightness.

(2) The requirements of subparagraph (1) shall not apply and the casing may accordingly be exposed—

(a) where there is no opening in the casing which gives direct access from the freeboard deck to the machinery space; or

(b) where the only opening in the casing has a steel weathertight door and leads to a space or passageway which is as strongly constructed as the casing and is separated from the stairway to the machinery space by a second steel weathertight door.

18. (1) References in this paragraph to a poop or detached bridge include references to a deckhouse fitted in lieu of and serving the purpose of a poop or detached bridge. Gangway and access.

(2) Access between the poop and the detached bridge shall be by means of either—

(a) a permanent and efficiently constructed gangway of substantial strength connecting those structures and meeting the following requirements:

(i) the gangway shall be at the level of the superstructure deck and have a platform at least 1 metre in width and of non-slip material;

(ii) efficient means of access from gangway level to the deck shall be provided at each terminal point;

(iii) the platform shall be fitted at each side throughout its length with guard rails or guard wires supported by stanchions; such rails or wires shall consist of not less than 3 courses, the lowest being not more than 230 millimetres, and the uppermost being at least 1 metre, above the platform, and no intermediate opening being more than 380 millimetres in height and the supporting stanchions shall be at intervals of not more than 1.5 metres; or

(b) an underdeck passage connecting and providing unobstructed access between those structures and complying with the requirements of subparagraph (3); or

(c) equivalent means of access.

(3) An underdeck passage provided pursuant to subparagraph (2)(b) shall comply with the following requirements:

(a) the passage and all fittings therein shall be oil and gas tight;

(b) the passage shall be well lighted, and be fitted with efficient gas detection and ventilation systems;

- (c) the passage shall be situated immediately below the freeboard deck;
- (d) the distance of the passage from the shell plating shall at no point throughout its length be less than one fifth of the breadth (B) of the ship, however in the case of a ship so designed as to render compliance with this requirement not reasonably practicable, two underdeck passages may be provided one to port and one to starboard each of which shall comply with all requirements of this paragraph except this requirement;
- (e) the means of exit from the passage to the freeboard deck shall be—
  - (i) so arranged as to be as near as practicable to the working areas to be used by the crew;
  - (ii) in no case be more than 90 metres apart; and
  - (iii) fitted with efficient means of closing which are capable of quick release and operable from either side;
- (f) the openings in the freeboard deck corresponding to the means of exit referred to in item (e) shall be protected in accordance with the requirements of paragraph 8(2)(a).

(4) In the case of a ship the crew of which may, in the course of their duties, be required to go in adverse weather conditions to a position or positions forward of the detached bridge, or forward of the poop in cases where there is no detached bridge, and all crew accommodation and machinery spaces are situated at the after end of the ship, access to such positions shall be by means of either—

- (a) a gangway complying with the requirements of subparagraph (2)(a);
  - (b) an underdeck passage complying with the requirements of subparagraph (3); or
  - (c) a walkway complying with the requirements of subparagraph (5).
- (5) A walkway provided pursuant to subparagraph (4)(c) shall—
- (a) be not less than 1 metre in width and be situated on or as near as practicable to the centre line of the ship;
  - (b) be fitted at each side throughout its length with guard rails or guard wires complying with the requirements set out in relation to such rails or wires in subparagraph (2)(a);
  - (c) have openings giving free access to and from the freeboard deck, set in such guard rails or guard wires as near as practicable to the working areas to be used by the crew, so however that such openings shall be on alternate sides of the walkway and be situated not more than 90 metres apart on either side;

- (d) if the length of exposed deck to be traversed exceeds 70 metres, have shelters of substantial construction set in way of the walkway at intervals not exceeding 45 metres, every such shelter being capable of accommodating at least one person and so constructed as to afford weather protection on the forward, port and starboard sides;
- (e) if obstructed by pipes or other fittings of a permanent nature, be provided with efficient means of passage over such obstruction.

(6) The requirements of this paragraph shall not apply in the case of unmanned barges.

19. The covers of hatchways in an exposed position on the freeboard deck, on a forecastle deck or on the top of an expansion trunk shall be of steel, of efficient construction, and weathertight when secured.

Hatchway covers.

20. (1) All exposed parts of the freeboard deck and superstructure decks shall be fitted at their perimeter for at least half their length with guard rails or guard wires in lieu of bulwarks or with other equally effective freeing arrangements and such guard rails or guard wires shall comply with the requirements set out in relation to such rails or wires in paragraph 18(2)(a).

Freeing arrangements.

(2) The upper edge of the sheer strake shall be as low as practicable.

(3) If superstructures of the ship are connected by a trunk, the exposed parts of the freeboard deck in way of the trunk shall be fitted at their perimeter throughout their length with guard rails or guard wires complying with the requirements set out in relation to such rails or wires in paragraph 18(2)(a).

(4) If the ship is so constructed that notwithstanding the provision of freeing ports and arrangements it will be particularly subjected under service conditions to the building up of quantities of water on the freeboard deck, efficient breakwaters shall be fitted in suitable positions on that deck.

### PART III

#### SPECIAL REQUIREMENTS APPLICABLE TO CERTAIN TYPE "B" SHIPS

21. Paragraphs 22 to 25 apply only in the case of Type "B" ships to be assigned a reduced freeboard under paragraph 5 of the Fifth Schedule.

Application.

22. The requirements concerning gangway and access to the ship shall comply with either—

Gangway and access.

- (a) paragraph 18 as if it were Type "A" ship; or
- (b) paragraphs 23 and 24.

**LAWS OF TRINIDAD AND TOBAGO**

MINISTRY OF THE ATTORNEY GENERAL AND LEGAL AFFAIRS

www.legalaffairs.gov.tt

536

**Chap. 50:10**

*Shipping*

[Subsidiary]

*Shipping (Load Line) Regulations*

Access between  
poop and  
detached bridge.

23. (1) Reference in this paragraph to a poop or the detached bridge include references to a deckhouse fitted in lieu of and serving the purpose of a poop or detached bridge.

(2) Access between the poop and the detached bridge shall be by means of an efficiently constructed gangway of substantial strength connecting those structures, fitted on or near the centre line of the ship. The gangway shall be at least one metre in width and shall be fitted at each side throughout its length with guard rails or guard wires complying with the requirements set out in relation to such rails or wires in paragraph 18(2)(a) and if the length of the gangway exceeds seventy metres, shelters complying with the requirements set out in relation to the shelters in paragraph 18(5)(d) shall be provided in way of the gangway.

Access in  
adverse weather  
conditions.

24. In the case of a ship the crew of which may in the course of their duties be required to go in adverse weather conditions to a position or positions forward of the detached bridge or forward of the poop in cases where there is no detached bridge, and all crew accommodation and machinery spaces are situated at the after end of the ship, access to such positions shall be—

- (a) by the means described in paragraph 18(4);
- (b) by the means described in paragraph 23(2); or
- (c) equivalent means of access; save that in the case of a ship the hatchway coamings of which are 600 millimetres or more in height from the deck, two walkways giving access to the said positions and complying with the requirements are provided as follows:
  - (i) the walkways shall be efficiently constructed and of satisfactory strength;
  - (ii) the walkways shall be at least 1 metre in width and shall be fitted on the freeboard deck alongside the outboard structure of the hatchway coamings, one to port and the other to starboard of the hatchways;
  - (iii) each walkway shall be fitted on the side outboard of the hatchways with guard rails or guard wires complying with the requirements set out in relation to such rails or wires in paragraph 18(2)(a).

Freeing  
arrangements.

25. The ship shall comply with the requirements of paragraph 20(4).

**PART IV**

**SPECIAL REQUIREMENTS APPLICABLE TO SHIPS TO  
BE ASSIGNED TIMBER FREEBOARDS**

Application.

26. The requirements of paragraphs 27 to 29 of this Part apply only in the case of ships to be assigned Timber Freeboards.

UNOFFICIAL VERSION

UPDATED TO 31ST DECEMBER 2016

27. (1) The ship shall have a forecastle of not less than the standard height of an enclosed superstructure and not less in length than 0.07 (L). Superstructures.

(2) If the ship is less than 100 metres in length it shall be fitted aft with either—

- (a) a poop of not less than standard height; or
- (b) a raised quarterdeck having either a deckhouse or a strong steel hood, so that the total height thereof is not less than the standard height of an enclosed superstructure.

28. Double bottom tanks where fitted within the midship half length of the ship shall have satisfactory watertight longitudinal subdivision. Double bottom tanks.

29. The ship shall be fitted with either—

- (a) permanent bulwarks at least one metre in height which are specially stiffened on the upper edge and supported by strong bulwark stays attached to the deck, and are provided with freeing ports complying with the requirements of paragraph 14(1) to (6); or
- (b) efficient guard rails and stanchions at least one metre in height, of specially strong construction, and complying with the requirements of paragraph 15(4).

Bulwarks,  
guards, rails and  
stanchions.

#### PART V

#### GENERAL

30. The Assigning Authority may with the approval of the Minister— Equivalent or  
exceptional  
provision.

- (a) allow any fitting, material, appliance or apparatus to be fitted in a ship or allow other provision to be made in a ship, in the place of any fitting, material, appliance, apparatus or provision respectively which is required under this Schedule, if satisfied by trial thereof or otherwise that it is at least as effective as that so required; or
- (b) allow in any exceptional case departures from the requirements of the said provisions on condition that the freeboards to be assigned to the ship are increased to such an extent as to satisfy the Minister that the safety of the ship and protection afforded to the crew will be no less effective than would be the case if the ship fully complied with those requirements and there were no such increase of freeboards.

Regulation 36.

## FIFTH SCHEDULE

## FREEBOARDS

Interpretation.

1. In this Schedule expressions defined in the Fourth Schedule have the meanings thereby assigned to them respectively, and—”block coefficient”: or the symbol “(C<sub>b</sub>)” in relation to a ship means the product of—

$$\frac{\nabla}{L \cdot B d_1}$$

Where —

$\nabla$  is the volume of the moulded displacement of the ship (excluding bossing) if the ship has a metal shell, and of displacement to the outer surface of the hull if the ship has a shell of any other material, displacement being taken in each case at a moulded draught of  $d_1$ , and

$d_1$  is 85 per cent of the least moulded depth; and in no case shall the block coefficient (C<sub>b</sub>) be taken to be less than 0.68;

“depth for freeboard” and the symbol “(D)” in relation to a ship means—

(a) except as otherwise stated in item (b), the moulded depth of the ship amidships plus the thickness of the freeboard deck stringer plate where fitted, plus, where the exposed freeboard deck is sheathed, the product of  $\frac{T(L)-(S)}{L}$  where T is the mean thickness of the exposed sheathing clear of deck openings;

(b) in the case of a ship having a rounded gunwale with a radius greater than 4 per cent of the breadth of the ship (B), or having topsides of unusual form, the depth, calculated in accordance with item (a), which would be the depth for freeboard purposes of a ship having a midship section with vertical topsides and with the same round of beam and the same area of topside section as that of the midship section of the first mentioned ship;

“effective length” and the symbol “(E)” in relation to a superstructure means the effective length of the superstructure ascertained in accordance with paragraph 9 of this Schedule;

“flush deck ship” means a ship which has no superstructure on the freeboard deck;

“length” and the symbol “(S)” in relation to a superstructure means the length of the superstructure ascertained in accordance with paragraph 9 of this Schedule;

“moulded depth” in relation to a ship means the vertical distance measured from the top of the keel to the top of the freeboard deck beam at side.

However—

- (a) in the case of a wood or composite ship, it shall be measured from the lower edge of the keel rabbet;
- (b) where the form at the lower part of the midship section of the ship is of a hollow character, or if thick garboards are fitted, it shall be measured from the point where the line of the flat of the bottom continued inwards cuts the side of the keel;
- (c) in the case of a ship having rounded gunwales, it shall be measured to the point of intersection of the moulded lines of the deck and side shell plating, the lines extending as though the gunwale were of angular design;
- (d) where the freeboard deck is stepped and the raised part of the deck extends over the point at which the moulded depth is to be determined, it shall be measured to a line of reference extending from the lower part of the deck along a line parallel to the raised part of the deck;

“summer draught” in relation to a ship means the draught measured from—

- (a) in the case of a wood or composite ship, the lower edge of the keel rabbet;
- (b) where the form at the lower part of the midship section is of a hollow character, or where thick garboards are fitted, the point where the line of the flat of the bottom continued inwards cuts the side of the keel;
- (c) in any other case the top of the keel;

“summer timber draught” in relation to a ship means the draught measured from point (a), (b) or (c) described in the preceding definition to the point which when timber load lines have been marked on the ship’s side will correspond to the upper edge of the Summer Timber load line;

“tabular freeboard” means in the case of a Type “A” ship the freeboard appropriate to the ship’s length under Freeboard Table A set out in the Sixth Schedule and in the case of a Type “B” ship the Freeboard Table B in that Schedule.

2. (1) Except as otherwise provided in subparagraphs (2) and (3), the freeboards to be assigned to a ship other than Timber Freeboards shall be determined in accordance with the provisions of Part I of this Schedule, and Timber Freeboards to be assigned to a ship shall be determined in accordance with Part II.

(2) Freeboards determined as described in subparagraph (1) are the Freeboards appropriate to ships the structural strength of which complies with the highest standard required by an Assigning Authority; and the Freeboards to be assigned to ships the structural strength of which does not comply with that standard shall be Freeboards so determined but increased in each case by such amount as the Assigning Authority, with the approval of the Minister may determine as appropriate to the ship's structural strength.

(3) The Freeboards to be assigned to—

- (a) sailing ships;
- (b) tugs;
- (c) ships of wood or of composite construction or of other materials;
- (d) ships with constructional features such as to render Freeboards determined as described in subparagraph (1) unreasonable or impracticable; and
- (e) unmanned barges having on the freeboard deck only small access openings closed by watertight gasketed covers of steel; shall be determined in accordance with the provisions of Part III of this Schedule.

#### PART I

### FREEBOARDS OTHER THAN TIMBER FREEBOARDS

Determination  
of freeboards.

3. (1) The Summer freeboard shall be determined in accordance with the provisions of paragraphs 4 to 16 of this Schedule and the freeboard so obtained, but omitting any correction made for deckline as provided in paragraph 8, shall be not less than 50 millimetres, except in case of a ship with hatchways in Position 1 to which paragraph 5 of the Fourth Schedule applies but which do not have pontoon covers, in which case it shall be not less than 150 millimetres.

(2) The Tropical freeboard shall be obtained by deducting from the Summer freeboard applicable to the ship one forty-eighth (1/48th) of the summer draught of the ship and the freeboard so obtained, but omitting any correction made for deckline as provided in paragraph 8, shall be not less than 50 millimetres except in the case of a ship with hatchways in Position 1 to which paragraph 5 of the Fourth Schedule applies but which do not have pontoon covers, in which case it shall be not less than 150 millimetres.

(3) The Winter freeboard shall be obtained by adding to the Summer freeboard applicable to the ship one forty-eighth (1/48th) of the summer draught of the ship.

(4) The Winter North Atlantic freeboard shall be obtained by adding to the Winter freeboard applicable to the ship a distance of 50 millimetres.

UNOFFICIAL VERSION

UPDATED TO 31ST DECEMBER 2016

(5) The Fresh Water freeboard shall, subject to subparagraph (6), be obtained by deducting from the Summer freeboard the quantity—

$$\frac{\Delta}{4T} \text{ millimetres}$$

where  $\Delta$  is the displacement in salt water in metric tons at the Summer load waterline, and T represents metric tonnes per centimetre immersion in salt water at that waterline.

(6) In any case in which the displacement at the waterline referred to in subparagraph (5) cannot be ascertained the deduction shall be one-forty-eighth (1/48th) of the summer draught of the ship.

4. The Summer freeboard to be assigned to a Type “A” ship shall be determined as follows:

Summer freeboard Type “A” ships.

- (a) there shall first be ascertained the ship’s tabular freeboard;
- (b) where the block coefficient ( $C_b$ ) of the ship exceeds 0.68 the tabular freeboard shall be multiplied by the factor

$$\frac{(C_b) + 0.68}{1.36}$$

- (c) corrections in accordance with paragraphs 6 to 16 of this Schedule shall be applied to the freeboard ascertained in accordance with items (a) and (b);
- (d) subject to paragraph 3(1), the freeboard so corrected shall be the Summer freeboard to be assigned to the ship.

5. (1) The Summer freeboard to be assigned to a Type “B” ship shall be determined as laid down in subparagraphs (2) to (13).

Summer freeboard Type “B” ships.

- (2) There shall first be ascertained the ship’s tabular freeboard—
  - (a) where the ship has hatchways in Position 1 the covers of which are—
    - (i) pontoon covers complying with the requirements of paragraph 5(4) of the Fourth Schedule; or
    - (ii) covers which comply with those of paragraph 6 of the Fourth Schedule; the tabular freeboard may be corrected in accordance with such of the provisions of subparagraphs (3) to (7) as are applicable to the ship;
  - (b) where the ship has hatchways in Position 1 the covers of which comply with the requirements of paragraph 5 of the Fourth Schedule, except those of subparagraph (4) of that paragraph, the tabular freeboard shall be corrected in accordance with the provisions of subparagraph (8) of this paragraph.

(3) The tabular freeboard of a ship to which subparagraph (2)(a) applies and which exceeds 100 metres in length may be reduced by an amount not exceeding the maximum applicable under subparagraphs (4) and (5) where the Assigning Authority is satisfied that—

- (a) the measures for the protection of the crew comply with the requirements of paragraph 15 of the Fourth Schedule;
- (b) the freeing arrangements comply with the requirements of paragraph 14 of the Fourth Schedule;
- (c) all covers of hatchways in Positions 1 and 2 comply with the requirements of paragraph 6 of the Fourth Schedule;
- (d) the ship when loaded to the Summer load waterline will remain afloat, after the flooding of any single damaged compartment other than the machinery space at an assumed permeability of 0.95, in the condition of equilibrium described in subparagraph (7); however, where the length of the ship exceeds 225 metres the machinery space shall rank as a floodable compartment for the purposes of this requirement having for the purpose an assumed permeability of 0.85.

(4) Subject to subparagraph (5) no reduction of freeboard pursuant to subparagraph (3) shall exceed 60 per cent of the difference between the tabular freeboards appropriate to the ship's length under Freeboard Table A and Freeboard Table B.

(5) The reduction of 60 per cent referred to in the preceding paragraph may be increased to 100 per cent where the Assigning Authority is satisfied that—

- (a) the ship complies with the requirements of paragraphs 17 and 20 of the Fourth Schedule as if it were a Type "A" ship and with the requirements of paragraph 22 of that Schedule;
- (b) the ship complies with the requirements of subparagraph (3)(a) to (c); and
- (c) the ship when loaded to the Summer load waterline will remain afloat in the condition of equilibrium described in subparagraph (6) after the flooding—
  - (i) of any two compartments adjacent fore and aft, neither of which is the machinery space, at an assumed permeability of 0.95; and
  - (ii) in the case of a ship exceeding 225 metres in length of the machinery space alone, at an assumed permeability of 0.85.

(6) The condition of equilibrium referred to in subparagraphs (3) and (5) is as follows:

- (a) the final waterline after flooding is below the top of any ventilator coaming, the lower edge of any air pipe opening,

- the upper edge of the sill of any access opening fitted with a weathertight door, and the lower edge of any other opening through which progressive flooding may take place;
- (b) the angle of heel due to unsymmetrical flooding does not exceed 15 degrees;
  - (c) the metacentric height calculated using the constant displacement method has a positive value of at least 50 millimetres in the upright condition after flooding; and
  - (d) the ship has adequate residual stability.
- (7) The following assumptions shall be made for the purposes of calculations pursuant to subparagraphs (3)(d) and (5)(c):
- (a) that the vertical extent of damage is equal to the depth of the ship at the point of damage, measured from and including the freeboard deck at side to the underside of the keel;
  - (b) that the transverse penetration of damage is not more than one-fifth of the breadth of the ship (B), this distance being measured inboard from the ship's side at right angles to the centre line of the ship at the level of the Summer load waterline;
  - (c) that in cases where damage of a lesser extent than that described in item (a) or (b) results in a more severe condition, such lesser extent shall be assumed;
  - (d) that, except in the case of compartments referred to in subparagraph 5(c)(i), no main transverse bulkhead is damaged;
  - (e) that the height of the centre of gravity above the baseline is assessed allowing for homogeneous loading of cargo holds and for 50 per cent of the designed capacity of consumable fluids and stores.

(8) (a) Tabular freeboard of a ship to which subparagraph (2)(b) applies shall be increased by the amount shown by the following Table to be appropriate to the ship's length:

Length of ship (metres)	Freeboard increase (millimetres)	Length of ship (metres)	Freeboard increase (millimetres)	Length of ship (metres)	Freeboard increase (millimetres)
108 and below	50	139	175	170	290
109	52	140	181	171	292
110	55	141	186	172	294
111	57	142	191	297	297
112	59	143	196	299	299
113	62	144	201	301	301

**LAWS OF TRINIDAD AND TOBAGO**

MINISTRY OF THE ATTORNEY GENERAL AND LEGAL AFFAIRS

www.legalaffairs.gov.tt

544

**Chap. 50:10**

*Shipping*

[Subsidiary]

*Shipping (Load Line) Regulations*

Length of ship (metres)	Freeboard increase (millimetres)	Length of ship (metres)	Freeboard increase (millimetres)	Length of ship (metres)	Freeboard increase (millimetres)
114	64	145	206	304	304
115	68	146	210	177	306
116	70	147	215	178	308
117	73	148	219	179	311
118	76	149	224	180	313
119	80	150	228	181	315
120	84	151	232	182	318
121	87	152	236	183	320
122	91	153	240	184	322
123	95	154	244	185	325
124	99	155	247	186	327
125	103	156	251	187	329
126	108	157	254	188	332
127	112	158	258	189	334
128	116	159	261	190	336
129	121	160	264	191	339
130	126	161	267	192	341
131	131	162	270	193	343
132	136	163	273	194	346
133	142	164	275	195	348
134	147	165	278	196	350
135	153	166	280	197	353
136	159	167	283	198	355
137	164	168	285	199	357
138	170	169	287	200	358

(b) freeboards at intermediate lengths of ship shall be obtained by linear interpolation;

(c) the increase in the case of ships of more than 200 metres in length shall be such amount as the Minister may determine in each particular case.

(9) Subparagraph (10) applies to every Type “B” ship of not more than 100 metres in length having enclosed superstructures the total effective length of which does not exceed 35 per cent of the ship’s length (L).

(10) The freeboard calculated in respect of a ship referred to in subparagraph (10) in accordance with subparagraphs (2) and (8) shall be increased by an amount ascertained in accordance with the formula  $7.5 \frac{(100 - L)(0.35 E)}{L}$  millimetres.

(L)

UNOFFICIAL VERSION

UPDATED TO 31ST DECEMBER 2016

(11) In the case of a ship the block coefficient ( $C_b$ ) of which exceeds 0.68 the freeboard calculated in respect of the ship in accordance with subparagraphs (1) to (11) shall be multiplied by the factor  $\frac{C_b + 0.68}{1.36}$

(12) Corrections in accordance with paragraphs 6 to 16 of this Schedule shall be applied to the freeboard ascertained in accordance with subparagraphs (1) to (11) and, subject to paragraph 3(1), the freeboard so corrected shall be the summer freeboard to be assigned to the ship.

6. In the following paragraphs of this Schedule “basic freeboard” in relation to a ship means the Summer freeboard calculated for the ship in accordance with paragraph 4 or 5 whichever is applicable, but in the case of a Type “A” ship the corrections referred to in paragraph 4(c) and in the case of a Type “B” ship the corrections referred to in paragraph 5(13). Basic freeboard.

7. (1) Where the depth of freeboard ( $D$ ) of a ship exceeds  $\frac{L}{15}$ , the basic freeboard of the ship shall be increased by  $((D) - \frac{L}{15})R$  millimetres,  $R$  for this purpose being taken to be  $\frac{L}{0.48}$  in the case of a ship less than 120 metres in length, and 250 metres in the case of a ship of 120 metres or more in length. Correction for depth.

(2) Where the depth for freeboard ( $D$ ) of a ship is less than  $\frac{L}{15}$ , the basic freeboard of the ship shall be reduced by  $((D) - \frac{L}{15}) R$  millimetres if the ship has either —

- (a) an enclosed superstructure covering at least 0.6 ( $L$ ) amidships;
- (b) an efficient trunk extending for the ship’s length ( $L$ ); or
- (c) a combination of enclosed superstructures connected by efficient trunks, being a combination extending for the ship’s length ( $L$ ),

however, where the height of any such superstructure or trunk is less than standard height, the amount of such reduction shall be reduced in the ratio of the actual to the standard height of the superstructure or trunk.

8. Where the actual depth to the upper edge of the deckline is greater or less than the depth for freeboard ( $D$ ), the difference if greater shall be added to, or if less shall be deducted from, the basic freeboard of the ship; however, in a case in which the position of the deckline has been fixed in accordance with regulation 23(3) the actual depth of the ship shall be taken for the purposes of the foregoing requirement to the point amidships where the continuation outwards of the upper surface of the freeboard deck or of any sheathing of that deck intersects the outer surface of the shell of the ship. Correction for position of deck.

**LAWS OF TRINIDAD AND TOBAGO**

MINISTRY OF THE ATTORNEY GENERAL AND LEGAL AFFAIRS

www.legalaffairs.gov.tt

546

**Chap. 50:10**

*Shipping*

**[Subsidiary]**

*Shipping (Load Line) Regulations*

Standard height, length and effective length of superstructures.

9. (1) The standard height of a superstructure shall be the height appropriate to the ship's length (L) determined in accordance with the following table:

Length of ship (L) (metres)	Standard Height (metres)	
	of a raised quarterdeck	of a superstructure other than a raised quarterdeck
30 or less	0.90	1.80
75	1.20	1.80
125 or more	1.80	2.30

standard heights for intermediate lengths of ship shall be obtained by linear interpolation.

(2) Subject to subparagraph (3) the length of a superstructure (S) shall be the mean length of the parts of the superstructure which lie within the length of the ship (L).

(3) In the case of an enclosed superstructure having an end bulkhead which extends in a fair convex curve beyond its intersection with the superstructure sides, the length of the superstructure (S) may be taken as its length ascertained in accordance with subparagraph (2) increased on the basis of an equivalent plane bulkhead by the amount of two-thirds of the fore and aft extent of the curvature, so however that the amount of the curvature to be taken into account shall not exceed one-half the breadth of the superstructure at the point of intersection of the curved end of the superstructure with its side.

(4) The effective length of a superstructure (E) shall be as follows:

(a) subject to item (c), (E) in the case of an enclosed superstructure of standard height shall be either—

- (i) its length (S); or
- (ii) if the superstructure is set in from the sides of the ship, its length (S) modified in the ratio  $b/B_s$ , where—“b” is the breadth of the superstructure at the middle of its length (S) and “B<sub>s</sub>” is the breadth of the ship at the middle of the length of the superstructure (S),

so however that if the superstructure is so set in for part only of its length, such modification shall be applied only to that part;

(b) subject to item (c), (E) in the case of an enclosed superstructure of less than standard height shall be its length (S) reduced in the ratio of the actual height of the superstructure to its standard height;

UNOFFICIAL VERSION

UPDATED TO 31ST DECEMBER 2016

- (c) (E) in the case of an enclosed superstructure consisting of a raised quarterdeck shall, if the deck is fitted with an intact front bulkhead, be its length (S) subject to a maximum of 0.6 of the ship's length (L); and if not so fitted, be ascertained by treating the raised quarterdeck as a poop of less than standard height.

(5) A superstructure which is not an enclosed superstructure shall have no effective length.

10. (1) The standard height of a trunk shall be determined in the same manner as that applicable to a superstructure, other than a raised quarterdeck, under paragraph 9(1). Standard height and effective length of trunks.

(2) A trunk shall be treated as an efficient trunk subject to the following conditions:

- (a) that it shall be at least as strong as a superstructure;
- (b) that the hatchways in way of the trunk are in the trunk deck, and the hatchway coamings and covers comply with the requirements of paragraphs 4 to 6 of the Fourth Schedule; so however that small access openings with watertight covers shall be permitted in the freeboard deck;
- (c) that the width of the trunk deck stringer provides a satisfactory gangway and sufficient lateral stiffness;
- (d) that a permanent working platform fore and aft fitted with guard rails or guard wires complying with the requirements applicable thereto under paragraph 18(2)(a) of the Fourth Schedule is provided by the trunk deck, or by detached trunks connected to superstructures by efficient permanent gangways;
- (e) that ventilators are protected by the trunk, by watertight covers or by equivalent means;
- (f) that open rails or wires are fitted on the weather parts of the freeboard deck in way of the trunk for at least half their length;
- (g) that the machinery casings are protected by the trunk, or by an enclosed superstructure of at least standard height, or by a deckhouse of the same height and of strength and weathertightness equivalent to those of such a superstructure;
- (h) that the breadth of the trunk is at least 60 per cent of the breadth of the ship (B);
- (i) that where there is no superstructure the length of the trunk is at least 0.6 (L).

**LAWS OF TRINIDAD AND TOBAGO**

MINISTRY OF THE ATTORNEY GENERAL AND LEGAL AFFAIRS

www.legalaffairs.gov.tt

548

**Chap. 50:10**

*Shipping*

[Subsidiary]

*Shipping (Load Line) Regulations*

- (3) The effective length of a trunk shall be determined as follows:
- (a) except as otherwise provided in item (b), the effective length of an efficient trunk shall be its full length reduced in the ratio of its mean breadth to the breadth of the ship (B);
  - (b) where the actual height of an efficient trunk is less than the standard height, its effective length shall be the length calculated in accordance with item (a) reduced in the ratio of the actual to the standard height of the trunk; in addition, if the ship is a Type “B” ship and the height of hatchway coamings on the trunk deck is less than that required by paragraph 5(1) or 6(1) of the Fourth Schedule a reduction from the actual height of the trunk shall be made of an amount corresponding to the difference between the actual height of such coamings and the height so required for them.

(4) A trunk which is not an efficient trunk as described in subparagraph (2) shall have no effective length.

Deduction for effective length of superstructures and trunks.

11. (1) Where the sum of the effective lengths of superstructures of a ship is 1.0 (L), the basic freeboard of the ship shall be reduced—

- (a) by 350 millimetres if the ship is 24 metres in length (L);
- (b) by 860 millimetres if the ship is 85 metres in length (L)
- (c) by 1070 millimetres if the ship is 122 metres in length (L) or more; and
- (d) by amounts obtained by linear interpolation in the case of ships of intermediate length.

(2) The basic freeboard of a ship shall be reduced according to the total effective length of her superstructures and trunks as follows:

- (a) in the case of a Type “A” ship, by a percentage ascertained by reference to the following Table A:

**TABLE A**  
**PERCENTAGE OF DEDUCTION FOR TYPE “A” SHIPS**

Total effective length of superstructures and trunks	
0	0.1 (L) 0.2 (L) 0.3 (L) 0.4 (L) 0.5 (L) 0.6 (L) 0.7 (L) 0.8 (L) 0.9 (L) 1.0 (L)
Percentage of deduction for all types of superstructures	0    7    14    21    31    41    52    63    75.3    87.7    100

UNOFFICIAL VERSION

UPDATED TO 31ST DECEMBER 2016

- (b) the percentage of deduction in the case of a Type “A” ship having superstructures and trunks of an effective length intermediate to those specified in Table A shall be ascertained by linear interpolation;
- (c) in the case of a Type “B” ship, by a percentage ascertained by reference to the following Table B and to such of directions in item (e)(i) to (iii) as apply in the circumstances:

**TABLE B**  
**PERCENTAGE OF DEDUCTION FOR TYPE “B” SHIPS**

	Total effective length of superstructures and trunks											
	Line	0	0.1 (L)	0.2 (L)	0.3 (L)	0.4 (L)	0.5 (L)	0.6 (L)	0.7 (L)	0.8 (L)	0.9 (L)	1.0 (L)
Ships with forecastle and without detached bridge	1	0	5	10	15	23.5	32	45	63	75.3	87.7	100
Ships with forecastle and detached bridge	11	0	6.3	12.7	19	27.5	36	46	63	75.3	87.7	100

- (d) the percentage of deduction in the case of a Type “B” ship having superstructures and trunks of an effective length intermediate to those specified in Table B shall be ascertained by linear interpolation;
- (e)
  - (i) where the effective length of a bridge covers less than 0.1 (L) before amidships and 0.1 (L) abaft amidships, the percentages shall be obtained by linear interpolation between the lines I and II;
  - (ii) where the effective length of a forecastle is more than 0.4 (L), the percentages shall be obtained from line II;
  - (iii) where the effective length of a forecastle is less than 0.07 (L), the percentage obtained in accordance with sub-item (ii) shall be reduced by  $5 \times \frac{(0.07 (L) - f)}{0.07 (L)}$

where “f” is the effective length of the forecastle.

12. (1) The sheer shall be measured from the deck at side to a line of reference drawn parallel to the keel through the sheer line at amidships. Measurement of sheer.

**LAWS OF TRINIDAD AND TOBAGO**

MINISTRY OF THE ATTORNEY GENERAL AND LEGAL AFFAIRS

www.legalaffairs.gov.tt

550

**Chap. 50:10**

*Shipping*

**[Subsidiary]**

*Shipping (Load Line) Regulations*

(2) In ships designed with a rake of keel, the sheer shall be measured in relation to a line of reference drawn parallel to the Summer load waterline.

(3) In flush deck ships and in ships with detached superstructures, the sheer shall be measured at the freeboard deck.

(4) In ships with topsides of unusual form in which there is a step or break in the topsides, the sheer shall be considered in relation to the equivalent depth amidships.

(5) In ships with a superstructure of standard height which extends over the whole length of the freeboard deck, the sheer shall be measured at the superstructure deck.

(6) Where in ships referred to in subparagraph (5) the height of the superstructure exceeds the standard height the least difference (Z) between the actual and standard heights shall be added to each end ordinate.

(7) In ships referred to in subparagraph (5) the intermediate ordinates at distances of  $\frac{1}{6}$  (L) and  $\frac{1}{3}$  (L) from each perpendicular shall be increased by 0.444 (Z) and 0.111(Z) respectively.

(8) Where the deck of an enclosed superstructure has at least the same sheer as the exposed freeboard deck, the sheer of the enclosed portion of the freeboard deck shall not be taken into account.

(9) Where an enclosed poop or forecastle is either—

(a) of standard height with greater sheer than that of the freeboard deck; or

(b) is of more than standard height,

an addition to the sheer of the freeboard deck shall be made calculated in accordance with paragraph 14(6).

Standard sheer profile.

13. The ordinates of the standard sheer profile are given in the following Table:

	Station	Ordinate (in millimetres)	Factor
After half	After perpendicular .....	$25 \frac{((L) + 10)}{3}$	1
	.....	$11.1 \frac{((L) + 10)}{3}$	3
	$\frac{1}{6}$ (L) from A.P. ....	$2.8 \frac{((L) + 10)}{3}$	3
	.....	$\frac{3}{3}$	
	Amidships .....	0	1
Forward half	Amidships .....	0	1
	$\frac{1}{3}$ (L) from F.P. ....	$5.6 \frac{((L) + 10)}{3}$	3
	.....	$22.2 \frac{((L) + 10)}{3}$	3
	$\frac{1}{6}$ (L) from F.P. ....	$50 \frac{((L) + 10)}{3}$	1
	.....	$\frac{3}{3}$	
	Forward perpendicular .....	$50 \frac{((L) + 10)}{3}$	1

UNOFFICIAL VERSION

UPDATED TO 31ST DECEMBER 2016

14. (1) Where the sheer profile of a ship differs from the standard sheer profile, the four ordinates of each profile in the forward and after halves of the ship shall be multiplied by the appropriate factors given in the Table of Ordinates in paragraph 13; the difference between the sums of the respective products and those of the standard divided by 8 shall be the deficiency or excess of sheer in the forward or after half; the arithmetical mean of the excess or deficiency in the forward and after halves shall be the excess or deficiency of sheer.

Measurement of variation from standard sheer profile.

(2) Where the after half of the sheer profile is greater than the standard sheer profile and the forward half is less than the standard sheer profile, no credit shall be allowed for the part in excess, and deficiency only shall be measured.

(3) Where the forward half of the sheer profile exceeds the standard sheer profile, and the after half of the sheer profile is not less than 75 per cent of the standard sheer profile, credit shall be allowed for the part in excess.

(4) Where the after half of the sheer profile is less than 50 per cent of the standard sheer profile, no credit shall be given for the excess of sheer forward.

(5) Where the sheer in the after half is between 50 per cent and 75 per cent of the standard sheer profile, intermediate allowance may be granted for excess sheer forward.

(6) Where sheer credit is given for a poop or forecastle, the following formula shall be used:

$$s = \frac{y}{3} \times \frac{L}{(L)}$$

Where  $s$  = sheer credit to be deducted from the deficiency or added to the excess of sheer;

$y$  = difference between actual and standard height of superstructure at the end ordinate of sheer; and

$L$  = mean enclosed length of poop or forecastle up to a maximum length of 0.5 ( $L$ ).

(7) The formula in subparagraph (b) provides a curve in the form of a parabola tangential to the actual sheer at the freeboard deck and intersecting the end ordinate at a point below the superstructure deck at a distance equal to the standard height of the poop or forecastle. The superstructure deck shall not be less than standard height above this curve at any point. This curve shall be used in determining the sheer profile for forward and after halves of the ship.

15. (1) The correction for sheer shall be the deficiency or excess of sheer determined in accordance with paragraph 14 multiplied by—

Correction for variation from standard sheer profile.

$$0.75 \frac{-S}{2(L)}$$

(2) In the case of a ship with sheer less than the standard sheer profile, the correction for deficiency of sheer determined in accordance with subparagraph (1) shall be added to the basic freeboard of the ship.

(3) Subject to subparagraph (4), in the case of a ship having an excess of sheer—

- (a) where an enclosed superstructure covers 0.1 (L) before and 0.1 (L) abaft amidships, the correction for excess of sheer determined in accordance with subparagraph (1) shall be deducted from the basic freeboard of the ship;
- (b) where no enclosed superstructure covers amidships, no deductions shall be made from the basic freeboard of the ship;
- (c) where the enclosed superstructure covers less than 0.1 (L) before and 0.1 (L) abaft amidships, the correction for excess of sheer determined in accordance with subparagraph (1) shall be modified in the ratio of the amount of 0.2 (L) amidships which is covered by the superstructure, to 0.2 (L).

(4) The maximum deduction for excess sheer shall be at the rate of 125 millimetres per 100 metres of length (L).

Correction for minimum bow height.

16. (1) Except as otherwise provided in subparagraphs (2) and (3), where the bow height of a ship determined in accordance with subparagraph (4) is less than the minimum bow height appropriate to the ship determined in accordance with subparagraph (5), the freeboard determined for the ship in accordance with paragraphs 3 to 15 shall be increased by an amount equal to the difference between the bow height and the minimum bow height.

(2) Where an existing ship to which subparagraph (1) applies has been so constructed or modified as to comply with all the requirements of the Fourth Schedule applicable to a new ship of her type and is to be assigned freeboard determined in accordance with this Schedule, and—

- (a) the forecastle is less than 0.07 (L); or
- (b) the sheer extends for less than 15 per cent of the ship's length (L) measured from the forward perpendicular,

the freeboard determined for the ship in accordance with paragraphs 3 to 15 shall be increased by such amount as the Minister may determine in each particular case.

(3) In the case of a ship to which subparagraph (1) applies, being a ship which is constructed to meet exceptional operational requirements, the correction to be made pursuant to the preceding subparagraphs may be reduced or waived if the Minister is satisfied that the safety of the ship will not be impaired in consequence in the worst sea and weather conditions likely to be encountered by the ship in service.

(4) The bow height of a ship is the vertical distance at the forward perpendicular between the Summer load waterline of the ship at the designed trim and the top of the exposed deck at side ascertained as follows:

- (a) where the bow height is obtained by including sheer, the sheer shall extend for not less than 15 per cent of the ship's length (L) measured from the forward perpendicular;
- (b) where the bow height is obtained by including the height of a superstructure, such superstructure shall—
  - (i) extend from the stem to a point not less than 0.07 of the ship's length (L) measured from the forward perpendicular;
  - (ii) if the ship's length (L) is 100 metres or less, be an enclosed superstructure; and
  - (iii) if the ship's length (L) exceeds 100 metres in length, be fitted with satisfactory closing appliances.

(5) The minimum bow height for a ship shall be derived from formula 1 in the case of a ship of less than 250 metres in length (L) and from formula 2 in the case of a ship of 250 metres or more in length (L)—

Formula 1

$$56(L) \frac{1 - (L)}{500} \frac{1.36}{C_b + 0.68} \text{ millimetres}$$

Formula 2

$$7000 \frac{1.36}{C_b + 0.68} \text{ millimetres}$$

$C_b$  being taken as not less than 0.68 in the case of each formula.

## PART II

### TIMBER FREEBOARDS

17. The Summer Timber Freeboard shall be determined as follows:

Summer timber freeboard.

- (a) there shall first be ascertained the freeboard appropriate to the ship under paragraphs 5(2), (3)(a), (10), (11), (12) and (13);
- (b) corrections shall be applied to the freeboard so obtained in accordance with paragraphs 6 to 10;
- (c) deductions for the effective length of superstructures only shall be made from the freeboard obtained pursuant to the preceding items, in accordance with subparagraphs 11(1),

**LAWS OF TRINIDAD AND TOBAGO**

MINISTRY OF THE ATTORNEY GENERAL AND LEGAL AFFAIRS

www.legalaffairs.gov.tt

554

**Chap. 50:10**

*Shipping*

**[Subsidiary]**

*Shipping (Load Line) Regulations*

(2)(c), (d) but substituting for the Table “Percentage of Deduction for Type ‘B’ ships” therein the following Table:

**TABLE**

	Total effective length of superstructures										
	0	0.1 (L)	0.2 (L)	0.3 (L)	0.4 (L)	0.5 (L)	0.6 (L)	0.7 (L)	0.8 (L)	0.9 (L)	1.0 (L)
Percentage of deduction for all types of superstructures	20	31	42	53	64	70	76	82	88	94	100

Percentages at intermediate lengths of superstructures shall be obtained by linear interpolation.

(d) corrections shall be applied to the freeboard obtained pursuant to the preceding items in accordance with paragraphs 12 to 15 and the freeboard so corrected shall be the Summer Timber freeboard to be assigned to the ship.

Other timber freeboards.

18. (1) The Winter Timber freeboard shall be obtained by adding to the Summer Timber Freeboard one-thirty-sixth (1/36th) of the summer timber draught of the ship.

(2) The Winter North Atlantic Timber freeboard shall be the same as the Winter North Atlantic freeboard assigned to the ship.

(3) The Tropical Timber freeboard shall be obtained by deducting from the Summer Timber freeboard one-forty-eighth (1/48th) of the summer timber draught of the ship.

(4) The Fresh Water Timber freeboard shall, subject to subparagraph (5), be obtained by deducting from the Summer Timber freeboard the quantity—

$$\frac{\Delta}{4T} \text{ millimetres}$$

where  $\Delta$  is the displacement in salt water in metric tonnes at the waterline which will, when load lines have been marked on the ship’s side, correspond to the Summer Timber load line, and T represents metric tonnes per centimetre immersion in salt water at that waterline.

(5) In any case in which the displacement at the waterline referred to in subparagraph (4) cannot be ascertained the deduction shall be one forty-eighth (1/48th) of the summer timber draught of the ship.

UNOFFICIAL VERSION

UPDATED TO 31ST DECEMBER 2016

**PART III**

**SAILING SHIPS AND OTHER SHIPS**

19. The freeboards to be assigned to sailing ships and tugs shall be freeboards determined in accordance with Part I of this Schedule increased by such amounts as the Minister may direct in each particular case.

Sailing ships and tugs.

20. The freeboards to be assigned to ships of wood or of composite construction or of other materials, or to ships with constructional features such as to render freeboards calculated in accordance with Part I of this Schedule unreasonable or impracticable shall be determined by the Minister in each particular case.

Ships of wood and other ships.

21. The freeboards to be assigned to unmanned barges having on the freeboard deck only small access openings closed by watertight gasketed covers of steel shall be freeboards determined in accordance with Part I of this Schedule omitting paragraphs 5 and 16 and such freeboards may be reduced by such amounts not exceeding 25 per cent as the Minister may direct in each particular case.

Unmanned barges.

**SIXTH SCHEDULE**

**FREEBOARD TABLES**

1. The following is Freeboard Table A referred to in the definition of “tabular freeboard” in paragraph 1 of the Fifth Schedule.

Fifth Schedule.

**TABLE A**

**FREEBOARD TABLE FOR TYPE “A” SHIPS**

Length of ship (metres)	Freeboard (millimetres)	Length of ship (metres)	Freeboard (millimetres)	Length of ship (metres)	Freeboard (millimetres)
24	200	72	733	120	1459
25	208	73	746	121	1476
26	217	74	760	122	1494
27	225	75	773	123	1511
28	233	76	786	124	1528
29	242	77	800	125	1546
30	250	78	814	126	1563
31	258	79	828	127	1580
32	267	80	841	128	1598
33	275	81	855	129	1615
34	283	82	869	130	1632

**LAWS OF TRINIDAD AND TOBAGO**

MINISTRY OF THE ATTORNEY GENERAL AND LEGAL AFFAIRS

www.legalaffairs.gov.tt

556

**Chap. 50:10**

*Shipping*

**[Subsidiary]**

*Shipping (Load Line) Regulations*

**TABLE A—Continued**

Length of ship (metres)	Freeboard (millimetres)	Length of ship (metres)	Freeboard (millimetres)	Length of ship (metres)	Freeboard (millimetres)
35	292	83	883	131	1650
36	300	84	897	132	1667
37	308	85	911	133	1684
38	316	86	926	134	1702
39	325	87	940	135	1719
40	334	88	955	136	1736
41	344	89	969	137	1753
42	354	90	984	138	1770
43	364	91	999	139	1787
44	374	92	1014	140	1803
45	385	93	1029	141	1820
46	396	94	1044	142	1837
47	408	95	1059	143	1853
48	420	96	1074	144	1870
49	432	97	1089	145	1886
50	443	98	1105	146	1903
51	455	99	1120	147	1919
52	467	100	1135	148	1935
53	478	101	1151	149	1952
54	490	102	1166	150	1968
55	503	103	1181	151	1984
56	516	104	1196	152	2000
57	530	105	1212	153	2016
58	544	106	1228	154	2032
59	559	107	1244	155	2048
60	573	108	1260	156	2064
61	587	109	1276	157	2080
62	600	110	1293	158	2096
63	613	111	1309	159	2111
64	626	112	1326	160	2126
65	639	113	1342	161	2141
66	653	114	1359	162	2155
67	666	115	1376	163	2169
68	680	116	1392	164	2184
69	693	117	1409	165	2198
70	706	118	1426	166	2212
71	720	119	1442	167	2226

UNOFFICIAL VERSION

UPDATED TO 31ST DECEMBER 2016

Length of ship (metres)	Freeboard (millimetres)	Length of ship (metres)	Freeboard (millimetres)	Length of ship (metres)	Freeboard (millimetres)
168	2240	221	2801	274	3148
169	2254	222	2809	275	3153
170	2268	223	2817	276	3158
171	2281	224	2825	277	3163
172	2294	225	2833	278	3167
173	2307	226	2841	279	3172
174	2320	227	2849	280	3176
175	2332	228	2857	281	3181
176	2345	229	2865	282	3185
177	2357	230	2872	283	3189
178	2369	231	2880	284	3194
179	2381	232	2888	285	3198
180	2393	233	2895	286	3202
181	2405	234	2903	287	3207
182	2416	235	2910	288	3211
183	2428	236	2918	289	3215
184	2440	237	2925	290	3220
185	2451	238	2932	291	3224
186	2463	239	2939	292	3228
187	2474	240	2946	293	3233
188	2486	241	2953	294	3237
189	2497	242	2959	295	3241
190	2508	243	2966	296	3246
191	2519	244	2973	297	3250
192	2530	245	2979	298	3254
193	2541	246	2986	299	3258
194	2552	247	2993	300	3262
195	2562	248	3000	301	3266
196	2572	249	3006	302	3270
197	2582	250	3012	303	3274
198	2592	251	3018	304	3278
199	2602	252	3024	305	3281
200	2612	253	3030	306	3285
201	2622	254	3036	307	3288
202	2632	255	3042	308	3292
203	2641	256	3048	309	3295
204	2650	257	3054	310	3298
205	2659	258	3060	311	3302

**LAWS OF TRINIDAD AND TOBAGO**

MINISTRY OF THE ATTORNEY GENERAL AND LEGAL AFFAIRS

www.legalaffairs.gov.tt

558

**Chap. 50:10**

*Shipping*

[Subsidiary]

*Shipping (Load Line) Regulations*

**TABLE A—Continued**

Length of ship (metres)	Freeboard (millimetres)	Length of ship (metres)	Freeboard (millimetres)	Length of ship (metres)	Freeboard (millimetres)
206	2669	259	3066	312	3305
207	2678	260	3072	313	3308
208	2687	261	3078	314	3312
209	2696	262	3084	315	3315
210	2705	263	3089	316	3318
211	2714	264	3095	317	3322
212	2723	265	3101	318	3325
213	2732	266	3106	319	3328
214	2741	267	3112	320	3331
215	2749	268	3117	321	3334
216	2758	269	3123	322	3337
217	2767	270	3128	323	3339
218	2775	271	3133	324	3342
219	2784	272	3138	325	3345
220	2792	273	3143	326	3347
327	3350	340	3382	353	3412
328	3353	341	3385	354	3414
329	3355	342	3387	355	3416
330	3358	343	3389	356	3418
331	3361	344	3392	357	3420
332	3363	345	3394	358	3422
333	3366	346	3396	359	3423
334	3368	347	3399	360	3425
335	3371	348	3401	361	3427
336	3373	349	3403	362	3428
337	3375	350	3406	363	3430
338	3378	351	3408	364	3432
339	3380	352	3410	365	3433

Freeboards at intermediate lengths of ship shall be obtained by linear interpolation.

UNOFFICIAL VERSION

UPDATED TO 31ST DECEMBER 2016

2. The following is Freeboard Table B referred to in the definition of “tabular freeboard” in paragraph 1 of the Fifth Schedule:

**TABLE B**

**FREEBOARD TABLE FOR TYPE “B” SHIPS**

Length of ship (metres)	Freeboard (millimetres)	Length of ship (metres)	Freeboard (millimetres)	Length of ship (metres)	Freeboard (millimetres)
24	200	72	754	120	1690
25	208	73	769	121	1709
26	217	74	784	122	1729
27	225	75	800	123	1750
28	233	76	816	124	1771
29	242	77	833	125	1793
30	250	78	850	126	1815
31	258	79	868	127	1837
32	267	80	887	128	1859
33	275	81	905	129	1880
34	283	82	923	130	1901
35	292	83	942	131	1921
36	300	84	960	132	1940
37	308	85	978	133	1959
38	316	86	996	134	1979
39	325	87	1015	135	2000
40	334	88	1034	136	2021
41	344	89	1054	137	2043
42	354	90	1075	138	2065
43	364	91	1096	139	2087
44	374	92	1116	140	2109
45	385	93	1135	141	2130
46	396	94	1154	142	2151
47	408	95	1172	143	2171
48	420	96	1190	144	2190
49	432	97	1209	145	2209
50	443	98	1229	146	2229
51	455	99	1250	147	2250
52	467	100	1271	148	2271
53	478	101	1293	149	2293
54	490	102	1315	150	2315
55	503	103	1337	151	2334
56	516	104	1359	152	2354

LAWS OF TRINIDAD AND TOBAGO

MINISTRY OF THE ATTORNEY GENERAL AND LEGAL AFFAIRS

www.legalaffairs.gov.tt

560

Chap. 50:10

Shipping

[Subsidiary]

Shipping (Load Line) Regulations

TABLE B—Continued

Length of ship (metres)	Freeboard (millimetres)	Length of ship (metres)	Freeboard (millimetres)	Length of ship (metres)	Freeboard (millimetres)
57	530	105	1380	153	2375
58	544	106	1401	154	2396
59	559	107	1421	155	2418
60	573	108	1440	156	2440
61	587	109	1459	157	2460
62	601	110	1479	158	2480
63	615	111	1500	159	2500
64	629	112	1521	160	2520
65	644	113	1543	161	2540
66	659	114	1565	162	2560
67	674	115	1587	163	2580
68	689	116	1609	164	2600
69	705	117	1630	165	2620
70	721	118	1651	166	2640
71	738	119	1671	167	2660
168	2680	221	3601	274	4327
169	2698	222	3615	275	4339
170	2716	223	3630	276	4350
171	2735	224	3645	277	4362
172	2754	225	3660	278	4373
173	2774	226	3675	279	4385
174	2795	227	3690	280	4397
175	2815	228	3705	281	4408
176	2835	229	3720	282	4420
177	2855	230	3735	283	4432
178	2875	231	3750	284	4443
179	2895	232	3765	285	4455
180	2915	233	3780	286	4467
181	2933	234	3795	287	4478
182	2952	235	3808	288	4490
183	2970	236	3821	289	4502
184	2988	237	3835	290	4513
185	3007	238	3849	291	4525
186	3025	239	3864	292	4537
187	3044	240	3880	293	4548
188	3062	241	3893	294	4560
189	3080	242	3906	295	4572

UNOFFICIAL VERSION

UPDATED TO 31ST DECEMBER 2016

Length of ship (metres)	Freeboard (millimetres)	Length of ship (metres)	Freeboard (millimetres)	Length of ship (metres)	Freeboard (millimetres)
190	3098	243	3920	296	4583
191	3116	244	3934	297	4595
192	3134	245	3949	298	4607
193	3151	246	3965	299	4618
194	3167	247	3978	300	4630
195	3185	248	3992	301	4642
196	3202	249	4005	302	4654
197	3219	250	4018	303	4665
198	3235	251	4032	304	4676
199	3249	252	4045	305	4686
200	3264	253	4058	306	4695
201	3280	254	4072	307	4704
202	3296	255	4085	308	4714
203	3313	256	4098	309	4725
204	3330	257	4112	310	4736
205	3347	258	4125	311	4748
206	3363	259	4139	312	4757
207	3380	260	4152	313	4768
208	3397	261	4165	314	4779
209	3413	262	4177	315	4790
210	3430	263	4189	316	4801
211	3445	264	4201	317	4812
212	3460	265	4214	318	4823
213	3475	266	4227	319	4834
214	3490	267	4240	320	4844
215	3505	268	4252	321	4855
216	3520	269	4264	322	4866
217	3537	270	4276	323	4878
218	3554	271	4289	324	4890
219	3570	272	4302	325	4899
220	3586	273	4315	326	4909
327	4920	340	5055	353	5190
328	4931	341	5065	354	5200
329	4943	342	5075	355	5210
330	4955	343	5086	356	5220
331	4965	344	5097	357	5230
332	4975	345	5108	358	5240
333	4985	346	5119	359	5250

**LAWS OF TRINIDAD AND TOBAGO**

MINISTRY OF THE ATTORNEY GENERAL AND LEGAL AFFAIRS

www.legalaffairs.gov.tt

562

**Chap. 50:10**

*Shipping*

[Subsidiary]

*Shipping (Load Line) Regulations*

**TABLE B—Continued**

Length of ship (metres)	Freeboard (millimetres)	Length of ship (metres)	Freeboard (millimetres)	Length of ship (metres)	Freeboard (millimetres)
334	4995	347	5130	360	5260
335	5005	348	5140	361	5268
336	5015	349	5150	362	5276
337	5025	350	5160	363	5285
338	5035	351	5170	364	5294
339	5045	352	5180	365	5303

Freeboards at intermediate lengths of ship shall be obtained by linear interpolation.

UNOFFICIAL VERSION

UPDATED TO 31ST DECEMBER 2016

**SEVENTH SCHEDULE**

Regulations 12,  
13, 17, 38  
and 42.

**STABILITY AND LOADING**

**PART I**

**STABILITY CRITERIA**

*A—General*

1. The stability of any ship shall be adequate for all probable loading conditions and drafts and at no time shall the appropriate freeboard mark be submerged. Adequate stability.

2. Except where the Minister otherwise requires, having due regard to any special design features and service conditions, the stability of a ship will be considered as satisfactory upon compliance with the appropriate criteria contained in Part B. Stability to comply with criteria.

3. In order to properly assess the stability characteristics of a vessel and to determine the degree of compliance with the appropriate stability criteria, the basic stability data shall be based on an inclining test of the ship in the light ship condition, in accordance with regulation 42. Inclining Test.

*B—Details of Stability Criteria*

4. Passengers and cargo ships shall meet the following criteria: Passenger and Cargo ship.
- (a) the area under the curve of righting levers (GZ curve) shall not be less than—
    - (i) 0.055 metre-radians up to an angle of 30°;
    - (ii) 0.09 metre-radians up to an angle of either 40° or the angle at which the lower edges of any openings in the hull, superstructures or deckhouses, being openings which cannot be closed weathertight, are immersed if that angle is less;
    - (iii) 0.03 metre-radians between the angles of heel of 30° and 40° or such lesser angle as is referred to in sub-item (ii);
  - (b) the righting lever (GZ) shall be at least 0.20 metres at an angle of heel equal to or greater than 30°;
  - (c) the maximum righting level (GZ) shall occur at an angle of heel preferably exceeding 30° but in any case not less than 25°;
  - (d) the initial metacentric height (GM) should not be less than 0.15 metres.

LAWS OF TRINIDAD AND TOBAGO

MINISTRY OF THE ATTORNEY GENERAL AND LEGAL AFFAIRS

www.legalaffairs.gov.tt

564

Chap. 50:10

Shipping

[Subsidiary]

Shipping (Load Line) Regulations

Timber deck cargoes.

5. (1) For ships loaded with timber deck cargoes, the following criteria may be substituted for the criteria given in paragraph 4:

- (a) the area under the righting lever (GZ curve) shall not be less than 0.08 metre-radians up to an angle of either 40° or the angle at which the lower edges of any openings in the hull, superstructures or deckhouses, being openings which cannot be closed weathertight, are immersed if that angle is less;
- (b) the maximum value of the righting level (GZ) should be at least 0.25 metres;
- (c) at all times during a voyage the metacentric height (GM) should be positive after correction for the free surface effects of liquid in tanks and, where appropriate, the absorption of water by the deck cargo or ice accretion on the exposed surfaces;
- (d) in the departure condition the metacentric height should be less than 0.10 metres.

(2) In all cases the timber deck cargo shall—

- (a) be compactly stowed;
- (b) extended longitudinally between superstructures, or, where there is no limiting superstructure at the after end of the ship, the cargo shall extend at least to the after end of the aftermost hatchway;
- (c) extend transversely for the full beam of the ship after due allowance, not exceeding 4 per cent of the breadth of the ship, for a rounded gunwale or the fitting of the supporting uprights used in securing the cargo;
- (d) remain securely fixed at large angles of heel.

Additional criteria for passenger ships.

6. The following additional criteria shall apply to passenger ships:

- (a) the angle of heel on account of passengers crowding to one side of the ship shall not exceed 10°, using, under normal circumstances, a passenger distribution value of 4 persons per square metre.
- (b) The angle of heel on account of turning should not exceed 10° when calculated using the following formula:

$$M_R = 0.02 \frac{V_o^2}{L} \Delta \left( KG - \frac{d}{2} \right)$$

Where:

$M_R$  = heeling moment in metre-tonnes;

$V_o$  = service speed in m/s;

$L$  = length of ship at waterline in metres;

$\Delta$  = displacement in salt water in metric tonnes;

$d$  = means draught in metres;

$KG$  = height of centre of gravity above keel in metres.

UNOFFICIAL VERSION

UPDATED TO 31ST DECEMBER 2016

7. (1) New decked sea-going passenger and cargo ships of 24 metres in length and over, in addition to meeting the appropriate stability criteria laid down in paragraphs (4), (5) and (6), shall also comply with the weather criteria laid down in this paragraph. Weather criteria.

(2) The ability of the ship to withstand the combined effects of beam wind and rolling should be demonstrated, with reference to Figure 1 and Tables 1 to 4 as contained in subparagraph (5), for each standard condition of loading referred to in paragraphs 18, 19, and 20, as follows:

- (a) the ship is subjected to a steady wind pressure acting perpendicular to the ship's centreline which results in a steady wind heeling level ( $1w_1$ );
- (b) from the resultant angle of equilibrium  $Q$  which should not exceed  $16^\circ$  or 80 per cent of the angle of deck edge immersion, whichever is less, the ship is assumed to roll, owing to wave action, to windward to an angle of roll  $Q_1$ ;
- (c) the ship is then subjected to a gust wind pressure which results in a gust wind heeling lever ( $1w_2$ );
- (d) under these circumstances, with reference to figure 1, area "b" should be equal to or greater than area "a";
- (e) free surface effects should be taken into account, in accordance with paragraph 16 for each standard condition of loading being investigated.

(3) The wind heeling levers  $1w_1$  and  $1w_2$  referred to in subparagraph (2) are constant values at all angles of inclination and should be calculated as follows:

$$1w_1 = \frac{P.A.Z.}{\Delta} \text{ (m) and}$$

$$1w_2 = 1.51w_1 \text{ (m)}$$

where—

$P$  = 0.0514 tonnes per square metres under normal conditions or such lesser value as may be approved by the Minister for ships in restricted service;

$A$  = projected lateral area in square metres of the portion of the ship and deck cargo above the waterline;

$Z$  = vertical distance in metres from the centre of  $A$  to the centre of the underwater lateral area or approximately to a point at one-half the draught;

$\Delta$  = displacement (tonnes).

LAWS OF TRINIDAD AND TOBAGO

(4) The angle of roll ( $Q_1$ ) referred to in subparagraph (2) should be calculated, without taking into account the operation of any anti-rolling devices which may be fitted, as follows:

$$Q_1 = 10gk \cdot X_1 \cdot X_2 \cdot \sqrt{r \cdot s} \text{ (degrees);}$$

where—

$X_1$  = factor as shown in Table 1;

$X_2$  = factor as shown in Table 2;

$K$  = factor as follows;

$K$  = 1.0 for round-bilged ship having no bilge or bar keels;

$K$  = 0.7 for a ship having sharp bilges;

$K$  = as shown in table 3 for a ship having bilge keels, a bar keel or both;

$$r = 0.73 + 0.8 \text{ OG/d;}$$

where—

OG = distance in metres between the centre of gravity and the waterline (+ if centre of gravity is below the waterline – if it is below);

$d$  = mean moulded draught in metres of the ship;

$s$  = factor as shown in Table 4.

(5) The figure and tables referred to in subparagraphs (2) and (4) are as follows:

FIGURE 1

Severe wind and rolling criterion

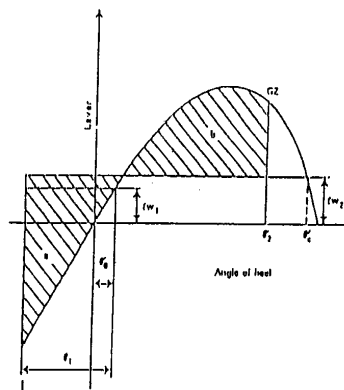

The angles in the above figure (on page 566) are defined as follows:

- $\theta_0$  = angle of heel under action of steady wind;
- $\theta_1$  = angle of roll to windward due to wave action
- $\theta_2$  = angle of downflooding ( $\theta_1$ ) or  $50^\circ$  or  $Q_c$  whichever is less;

where—

- $\theta_f$  = angle of heel at which openings in the hull, superstructures or deckhouses which cannot be closed weathertight immerse; in applying this criterion shall;
- $\theta_c$  = angle of second intercept between wind heeling lever  $w_2$  and  $GZ$  curves.

**Table 1**  
Values of factor  $X_1$

**Table 2**  
Values of factor  $X_2$

**Table 3**  
Values of factor  $k$

**Table 4**  
Values of factor  $s$

B/d	$X_1$	$C_B$	$X_2$	$\frac{Ak.100}{L.B}$	$k$	T	s
< 2.4	1.0	< 0.45	0.75	0	1.0	< 6	0.100
2.5	0.98	0.50	0.82	1.0	0.98	7	0.098
2.6	0.96	0.55	0.89	1.5	0.95	8	0.093
2.7	0.95	0.60	0.95	2.0	0.88	12	0.065
2.8	0.93	0.65	0.97	2.5	0.79	14	0.053
2.9	0.91	> 0.70	1.0	3.0	0.74	16	0.044
3.0	0.90			3.5	0.72	18	0.038
3.1	0.88			< 4.0	0.70	> 20	0.035
3.2	0.86						
3.3	0.84						
3.4	0.82	(Intermediate values in Tables 1–4 should be obtained by linear interpolation.)					
> 3.5	0.80						

Rolling period  $T = \frac{2.C.B.}{GM}$  (seconds)

where:  $C = 0.373 + 0.023 (B/d) - 0.043 (L/100)$ .

LAWS OF TRINIDAD AND TOBAGO

MINISTRY OF THE ATTORNEY GENERAL AND LEGAL AFFAIRS

www.legalaffairs.gov.tt

568

Chap. 50:10

Shipping

[Subsidiary]

Shipping (Load Line) Regulations

The symbols in the above Tables and formula for the rolling period are defined as follows:

- L = waterline length of the ship (m);
- B = moulded breadth of the ship (m);
- d = mean moulded draught of the ship (m);
- C<sub>B</sub> = block coefficient;
- A<sub>k</sub> = total overall area of bilge keels, or area of the lateral projection of the bar keel, or sum of these areas (m<sup>2</sup>);
- GM = metacentric height corrected for free surface effect (m).

PART II

CALCULATION OF STABILITY CURVES AND RELATED DATA

A—General

Calculation of stability curves.

8. Hydrostatic and stability curves should normally be prepared on a designed trim basis, however, where the operating trim or the form and arrangement of the ship are such that change in trim has an appreciable effect on righting arms, such change in trim should be taken into account.

Dimension of hull.

9. The calculation of hydrostatic and stability curves should take into account the volume of the hull to the upper surface of the deck sheathing; and in the case of wood ships the dimensions for breadth should be taken to the outside of the hull planking.

B—Superstructures, Deckhouses and Tanks which may be taken into Account

Treatment of spaces.

10. The volumes of superstructures, deckhouses and trunks are to be dealt with, so far as their contribution to the ship's buoyancy is concerned, in accordance with paragraphs 11 to 15.

Superstructures.

11. (1) Enclosed superstructures as defined in and meeting the requirements of paragraph 1 of the Fourth Schedule may be taken into account.

(2) The second tier of similarly enclosed superstructures may also be taken into account.

Deckhouses.

12. (1) Deckhouses which are situated on the freeboard deck—

(a) which comply with the conditions for enclosed superstructures as in paragraph 11 may be taken into account;

UNOFFICIAL VERSION

UPDATED TO 31ST DECEMBER 2016

- (b) which comply with the conditions for enclosed superstructures as in paragraph 11, except that no additional exit from the deckhouse to the deck above is provided, shall not be taken into account; however, any deck openings inside such deckhouses shall be considered as closed even where no means of closure is provided;
  - (c) the doors of which do not comply with the requirements of paragraph 1 of the Fourth Schedule shall not be taken into account; however, any deck openings inside the deckhouse may be regarded as closed where their means of closure comply with the requirements of paragraph 5, 7, or 8 of the Fourth Schedule.
- (2) Except as provided in subparagraph (3), deckhouses situated on decks above the freeboard deck shall not be taken into account, but openings within them may be considered as closed.
- (3) Subject to the approval of the Minister, a deckhouse situated on a deck above the freeboard deck may be taken into account where—
- (a) its location and integrity are such that it will contribute to the ship's stability;
  - (b) it is weathertight as defined in paragraph 1 of the Fourth Schedule.

13. (1) Superstructures and deckhouses which do not comply with the requirements for being considered enclosed may be taken into account in stability calculations up to the angle at which their openings are flooded; at this angle the static stability curve should show one or more steps, and in subsequent computations the flooded space should be regarded as non-existent. Flooding of openings.

(2) In cases where the ship would sink due to flooding through any openings the stability curve should be cut short at the corresponding angle of flooding and the ship should be considered as having entirely lost her stability.

14. An efficient trunk, as defined in and meeting the requirements of paragraph 10 of the Fifth Schedule, may be taken into account. Trunks.

15. Hatchways may be taken into account having regard to the effectiveness of their closures. Hatchways.

*C—Effects of Free Surface*

16. For all conditions, the metacentric height and the stability curves should be corrected for the effect of free surfaces of liquids in tanks in accordance with the following assumptions: Free Surface corrections.

- (a) tanks which are taken into consideration when determining the effect of liquids on the stability at all angles of inclination should

- include single tanks or combinations of tanks for each kind of liquid, including those for water ballast, which, according to the service conditions, can simultaneously have free surfaces;
- (b) for the purposes of determining this free surface correction, the tanks assumed slack should be those which develop the greatest free surface moment,  $M_{R,6}$  at a  $30^\circ$  inclination when in the 50 per cent full condition;
- (c) the value of  $M_{r,s}$  for each tank may be derived from the formula:

$$M_{r,s} = v b_r k \sqrt{b}$$

where— $M_{r,s}$  = the free surface moment at any inclination in metre-tons;

$v$  = the tank total capacity in  $m^3$ ;

$b$  = the tank maximum breadth in m;

$r$  = the specific weight of liquid in the tank in  $1/m^3$ ;

$o$  =  $\frac{v}{b l h}$  the tank block coefficient;

$h$  = the tank maximum height in m;

$l$  = the tank maximum length in m;

$k$  = dimensionless coefficient to be determined from the following Table according to the ratio  $b/h$ . The intermediate values are determined by interpolation (linear or graphic).

- (d) Small tanks, which satisfy the following condition using the value of  $k$  corresponding to the angle of inclination of  $30^\circ$ , need not be included in computation:

$$\frac{v b r k o}{\Delta_{\min}} < 0.01 m$$

where— $\Delta_{\min}$  = minimum ship displacement in tonnes (metric tonnes).

- (e) The usual remainder of liquids in the empty tanks is not taken into account in computation.

TABLE 5

TABLE OF VALUES FOR COEFFICIENT “K” FOR CALCULATING  
 FREE SURFACE CORRECTIONS

$$k = \frac{\sin \theta}{12} (1 + \frac{\tan \theta}{2}) \times \frac{b}{h}$$

$$k = \frac{\cos \theta}{8} (1 + \frac{\tan \theta}{b/h}) - \frac{\cos \theta}{12(b/h)^2} (1 + \frac{\cot \theta}{2})$$

where  $\cot \theta > b/h$

where  $\cot \theta < b/h$

b/h	0	5°	10°	15°	20°	30°	40°	45°	50°	60°	70°	75°	80°	90°	0	b/h
20		0.11	0.12	0.12	0.12	0.11	0.10	0.09	0.09	0.07	0.05	0.04	0.03	0.01	20	
10		0.07	0.11	0.12	0.12	0.11	0.10	0.10	0.09	0.07	0.05	0.04	0.03	0.01	10	
5		0.04	0.07	0.10	0.11	0.11	0.11	0.10	0.10	0.08	0.07	0.06	0.05	0.03	5	
3		0.02	0.04	0.07	0.09	0.11	0.11	0.11	0.10	0.09	0.08	0.07	0.06	0.04	3	
2		0.01	0.03	0.04	0.06	0.09	0.11	0.11	0.11	0.10	0.09	0.09	0.08	0.06	2	
1.5		0.01	0.02	0.03	0.05	0.07	0.10	0.11	0.11	0.11	0.11	0.10	0.10	0.08	1.5	
1		0.01	0.01	0.02	0.03	0.05	0.07	0.09	0.10	0.12	0.13	0.13	0.13	0.13	1	
0.75		0.01	0.01	0.02	0.02	0.04	0.05	0.07	0.08	0.12	0.15	0.16	0.16	0.17	0.75	
0.5		0.00	0.01	0.01	0.02	0.02	0.04	0.04	0.05	0.09	0.16	0.18	0.21	0.25	0.5	
0.3		0.00	0.00	0.01	0.01	0.01	0.02	0.03	0.03	0.05	0.11	0.19	0.27	0.42	0.3	
0.2		0.00	0.00	0.00	0.01	0.01	0.01	0.02	0.02	0.04	0.07	0.13	0.27	0.63	0.2	
0.1		0.00	0.00	0.00	0.00	0.00	0.01	0.01	0.01	0.01	0.04	0.06	0.14	0.25	0.1	

D—Effect of Timber Deck Cargo

17. In the case of ships carrying timber deck cargoes the buoyancy of such cargo may be taken into account, assuming the cargo to have a permeability of 25 per cent of its volume. Buoyancy of timber.

PART III

STANDARD CONDITIONS OF LOADING  
 TO BE EXAMINED

A—Loading Conditions

18. The following standard conditions of loading shall be examined with respect to passenger ships: Passenger’s ship.

- (a) ship in the fully loaded departure condition with full stores and fuel and with the full number of passengers with their luggage;

LAWS OF TRINIDAD AND TOBAGO

MINISTRY OF THE ATTORNEY GENERAL AND LEGAL AFFAIRS

www.legalaffairs.gov.tt

572

Chap. 50:10

Shipping

[Subsidiary]

Shipping (Load Line) Regulations

- (b) ship in the fully loaded arrival condition, with the full number of passengers and their luggage but with only 10 per cent stores and fuel remaining;
- (c) ship without cargo, but with full stores and fuel and the full number of passengers and their luggage;
- (d) ship in the same condition as at (c) above but with only 10 per cent stores and fuel remaining.

Cargo ships.

19. The following standard conditions of loading shall be examined with respect to cargo ships:

- (a) ship in the fully loaded departure condition, with cargo homogeneously distributed throughout all cargo spaces and with full stores and fuel;
- (b) ship in the fully loaded arrival condition with cargo homogeneously distributed throughout all cargo spaces and with 10 per cent stores and fuel remaining;
- (c) ship in ballast in the departure condition, without cargo, but with full stores and fuel;
- (d) ship in ballast in the arrival condition, without cargo and with 10 per cent stores and fuel remaining.

Cargo ships with deck cargoes.

20. In the case of cargo ships intending to carry deck cargoes, the following conditions shall be examined in addition to those in paragraph 19:

- (a) ship in the fully loaded departure condition, with cargo homogeneously distributed in the holds and with cargo specified in extension and weight on deck, with fully stores and fuel;
- (b) ship in the fully loaded arrival condition, with cargo homogeneously distributed in the holds and with cargo specified in extension and weight on deck, with 10 per cent stores and fuel.

*B—Assumptions for calculating the loading conditions*

Liquid cargo tanks.

21. Where a dry cargo ship is also fitted with cargo tanks capable of carrying liquid cargoes, the fully loaded conditions referred to in paragraphs 19(a) and (b) and 20(a) and (b) shall be examined in accordance with each of the following two assumptions:

- (a) that the cargo is homogeneously stowed excluding the liquid cargo tanks;

UNOFFICIAL VERSION

UPDATED TO 31ST DECEMBER 2016

(b) that the cargo is homogeneously stowed including the liquid cargo tanks.

22. In the fully loaded departure conditions mentioned in 18(a), 19(a) and 20(a) it should be assumed that the ship is loaded to her sub-division loadline, summer load line or, if the ship is marked with timber load lines, to the summer timber load line respectively, with water ballast tanks empty.

Appropriate load line for conditions.

23. Where in any loading condition it is necessary to carry water ballast, additional calculations are to be made taking into account the quantity and disposition of the water ballast.

Carriage of ballast.

24. In all cases the cargo in holds is assumed to be fully homogeneous unless this condition is inconsistent with the practical service of the ship.

Distribution of cargo.

25. (1) In all cases in which deck cargoes are carried the weight of the deck cargo and its height should be clearly stated in the calculation.

Deck cargoes.

(2) Where timber deck cargoes are carried the amount of cargo and ballast should correspond to the worst service condition in which all the relevant stability criteria in Part B of Part I of this Schedule are met. In the arrival condition it should be assumed that the weight of the timber deck cargo increased by 15 per cent due to water absorption.

(3) Where timber deck cargoes are carried and it is anticipated that some formation of ice will take place, an adequate allowance should be made in the arrival condition for the additional weight.

26. (1) In calculating passenger weights and distribution the weight for each passenger should normally be taken as 75 kg and the height of a passenger's centre of gravity should be taken as 1.0 metre above the deck when standing and 0.30 metre above the seat occupied when sitting.

Passenger ship.

(2) When assessing compliance with the relevant criteria in Part B of Part I of this Schedule passengers and luggage should be considered to be in the spaces normally at their disposal.

(3) When assessing compliance with the criteria in paragraph 6—

(a) under normal circumstances, a passenger distribution value of 4 persons per square metre should be used;

(b) passengers without luggage should be considered as being distributed to produce the most unfavourable combination of passenger heeling moment or initial metacentric height which may be obtained in practice.

LAWS OF TRINIDAD AND TOBAGO

MINISTRY OF THE ATTORNEY GENERAL AND LEGAL AFFAIRS

www.legalaffairs.gov.tt

574

Chap. 50:10

Shipping

[Subsidiary]

Shipping (Load Line) Regulations

PART IV

**STABILITY, LOADING AND BALLASTING INFORMATION  
TO BE PROVIDED ON BOARD SHIP FOR THE GUIDANCE  
OF THE MASTER**

- General. 27. The information to be provided on board ship for the guidance of the master shall be in the form of a book of the form and content laid down in this Part of this Schedule.
- Ship's main details. 28. The ship's name, official number, port of registry, gross and register tonnages, principal dimensions, displacement, deadweight and draught to the Summer load line shall be specified.
- Plans. 29. A profile view and, if necessary, plan views of the ship, drawn to scale showing, with their names, all compartments, tanks, holds, storerooms and crew and passenger accommodation spaces and also showing the ship's mid-length position shall be provided.
- Centres of gravity. 30. (1) The capacity and the position of the centre of gravity, longitudinally and vertically, of every compartment available for the carriage of cargo, fuel stores, feed water, domestic water or water ballast shall be given.
- (2) In the case of a vehicle ferry, the vertical centre of gravity of compartments for the carriage of vehicles shall be based on the estimated centres of gravity of the vehicles and not on the volumetric centres of gravity of the compartments.
- (3) The estimated total weight and the centre of gravity, longitudinally and vertically of—
- (a) passengers and their effects; and
  - (b) crew and their effects,
- shall be given.
- (4) In assessing such centres of gravity passengers and crew shall be assumed to be distributed about the ship in the spaces they will normally occupy, including the highest decks to which either or both have access.
- Deck cargo weight and centres of gravity. 31. (1) The estimated weight and the disposition and centre of gravity of the maximum amount of deck cargo which the ship may reasonably be expected to carry on an exposed deck shall be given.
- (2) The estimated weight of the deck cargo referred to in subparagraph (1) shall include, in the case of deck cargoes susceptible to water absorption, an estimated weight of water likely to be so absorbed, which should be allowed for in arrival conditions.

UNOFFICIAL VERSION

UPDATED TO 31ST DECEMBER 2016

(3) In the case of timber deck cargo the increase in weight due to water absorption shall be taken as 15 per cent of the weight of the cargo.

32. A diagram or scale shall be provided showing the load line mark and load lines with particular of the corresponding freeboards, and also showing the displacement, metric tonnes per centimetre immersion, and deadweight corresponding in each case to a range of mean draughts extending between the waterline representing the deepest loadline and the waterline of the ship in light condition.

Load line diagrams.

33. (1) A diagram or tabular statement, shall be made available showing the hydrostatic particulars of the ship, including—

Hydrostatic particulars.

- (a) the heights of the transverse and longitudinal metacentres above base line;
- (b) the positions of the centre of buoyancy, both vertical and longitudinal;
- (c) the positions of the longitudinal centre of flotation;
- (d) the values of the moments to change trim by one centimetre; and
- (e) the values of the cross-sectional areas (Bonjean curves) and the waterplane areas,

for a range of mean draughts extending at least between the waterline representing the deepest load line and the waterline of the ship in light condition.

(2) Where a tabular statement is used the intervals between such draughts shall be sufficiently close to permit accurate interpolation.

(3) In the case of ships having raked keels the datum line from which the heights of centres of buoyancy and metacentres are to be measured shall be the same data line used for the centres of gravity referred to in paragraphs 30 and 31.

34. (1) Values of free surface moments for each tank in the ship in which liquids may be carried shall be provided, such moments being calculated in accordance with paragraph 16.

Free surface.

(2) An example showing how the metacentric height is to be corrected regarding free surface shall be given.

35. (1) A diagram shall be provided showing cross curves of stability and indicating the height of the assumed axis from which the Righting Levers are measured, and the trim which has been assumed; in the case of ships having raked keels, where a datum other than top of keel has been used, the position of the assumed axis shall be clearly defined.

Cross curves of stability.

LAWS OF TRINIDAD AND TOBAGO

MINISTRY OF THE ATTORNEY GENERAL AND LEGAL AFFAIRS

www.legalaffairs.gov.tt

576

Chap. 50:10

Shipping

[Subsidiary]

Shipping (Load Line) Regulations

(2) In the case of a ship which may carry timber deck cargo, where the volume of such cargo, or a part thereof, has been taken into account in deriving a supplementary curve of stability appropriate to the ship when carrying such cargo, a diagram giving details of this supplementary curve should also be provided.

(3) Where the buoyancy of a superstructure or any other structure is taken into account in the calculation of stability information to be supplied to any ship, including vehicle ferries and similar vessels having bow doors, stern doors or ship's side doors—

- (a) a suitable endorsement shall always be made on the cross curves of stability clearly indicating the extent of such inclusion;
- (b) there shall be included in the stability information a specific statement that weathertight doors and any other special openings must be secured weathertight before the ship proceeds to sea and that the cross curves of stability are based upon the assumption that such doors and openings have been so secured;
- (c) warning notices shall be conspicuously displayed near the weathertight doors and other special openings to the effect that such openings must be declared weathertight before the ship proceeds to sea on account of stability, particularly in the case of roll-on roll-off ferries having bow, stern, or side doors.

Example of curve of righting levers from cross curves. Diagrams and statements.

36. An illustrative example shall be given showing how to obtain a curve of Righting Levers (GZ) from the cross curves.

37. (1) The following shall be made available for use on board ship:
- (a) profile diagrams of the ship drawn to a suitable small scale showing the disposition of all components to the deadweight;
  - (b) a statement showing the lightweight, the disposition and the total weights of all components of the deadweight, the displacement, the corresponding positions of the centre of gravity, the metacenter and also the metacentric height (GM); and
  - (c) a diagram showing a curve of Righting Levers (GZ) derived from the cross curves of stability referred to in paragraph 35; where credit is shown for the buoyancy of a timber deck cargo the curve of Righting Levers (GZ) must be drawn both with and without this credit.

Loading conditions.

38. (1) The diagram and statements referred to in paragraph 37 shall be provided separately for each for the following conditions of the ship:

- (a) *Light condition*—where the ship has permanent ballast, such diagram and statements shall be provided for the ship in light condition both with and without such ballast;

UNOFFICIAL VERSION

UPDATED TO 31ST DECEMBER 2016

- (b) *Ballast condition*—both on departure and on arrival, it being assumed for the purpose of the latter in this and the following items that fuel, fresh water and other consumables are reduced to 10 per cent of their capacity;
- (c) *Loaded condition*—both on departure, and on arrival, when loaded to the Summer load line with cargo filling all spaces available for cargo; cargo for this purpose being taken to be homogeneous cargo except where this is clearly inappropriate, for example in the case of cargo spaces in a ship which are intended to be used exclusively for the carriage of vehicles or of containers;
- (d) *Service loaded conditions*—both on departure and on arrival.
- (2) The metacentric height and the curve of Righting Levers (GZ) shall be corrected for liquid free surface effect.

---

**EIGHTH SCHEDULE**  
**FREEBOARDS FOR EXISTING SHIPS**

**PART I**

1. In this Schedule, unless the context otherwise requires, the following expressions have the meanings hereby respectively assigned to them: Definitions.

“amidships” means the middle of the length of the summer load waterline as defined in paragraph 26;

“conditions of assignment” means the conditions of assignment set out in Part II of this Schedule;

“flush deck ship” means a ship which has no superstructure on the freeboard deck;

“freeboard deck” means the uppermost complete deck having permanent means of closing all opening in weather portions of the deck in accordance with paragraphs 2 to 9, and in flush deck ships and ships with detached superstructures means the upper deck; in ships having discontinuous freeboard decks within superstructures which are not intact, or which are not fitted with Class I closing appliances, as defined in paragraph 37, the lowest line of the deck below the superstructure deck shall be deemed to be the freeboard deck;

“sailing ship” includes all ships provided with sufficient sail area for navigation under sails alone, whether or not fitted with mechanical means of propulsion;

“special steamer freeboard” means a freeboard assigned under Part VII of this Schedule;

LAWS OF TRINIDAD AND TOBAGO

MINISTRY OF THE ATTORNEY GENERAL AND LEGAL AFFAIRS

www.legalaffairs.gov.tt

578

Chap. 50:10

Shipping

[Subsidiary]

Shipping (Load Line) Regulations

“steamer” includes all ships having sufficient means for mechanical propulsion, except where provided with sufficient sail area for navigation under sails alone, and for the purposes of this Schedule a lighter, barge or other ship without independent means of propulsion, when towed, is deemed to be a steamer;

“superstructure” means a deck structure on the freeboard deck extending from side to side of the ship, and includes a raised quarterdeck;

“superstructure deck” means the deck forming the top of the superstructure;

“tanker” includes all steamers specially constructed for the carriage of liquid cargoes in bulk;

“timber deck cargo” means a cargo of timber carried on an uncovered part of a freeboard or superstructure deck, but does not include a cargo of wood pulp or similar substance;

“timber freeboard” means a freeboard assigned under Part V of this Schedule.

PART II

CONDITIONS OF ASSIGNMENT

A—Openings in Freeboard and Superstructure Decks

Hatchways not protected by superstructures.

2. The construction and fitting of cargo and other hatchways in exposed positions on freeboard and superstructure decks shall be at least equivalent to the standards laid down in paragraphs 3 to 9.

Hatchways coamings.

3. (1) The height of hatchway coamings on freeboard decks shall be at least 24 inches above the deck.

(2) The height of coamings on superstructure decks shall be at least 24 inches above the deck if situated within a quarter of the ship’s length from the stem, and at least 18 inches if situated elsewhere.

(3) Coamings shall—

(a) be made of steel;

(b) be substantially constructed; and

(c) where required to be 24 inches high, be fitted with an efficient horizontal stiffener placed not lower than 10 inches below the upper edge, and with efficient brackets or stays from the stiffener to the deck, at intervals of not more than 10 feet.

Hatchway covers.

4. (1) Covers to exposed hatchways shall be efficient, and where they are made of wood, the finished thickness shall be at least  $2 \frac{3}{8}$  inches in association with a span of not more than 5 feet.

(2) The width of each bearing surface for wood hatchway covers shall be at least  $2 \frac{1}{2}$  inches.

UNOFFICIAL VERSION

UPDATED TO 31ST DECEMBER 2016

(3) The ends of the wood covers shall be protected by galvanized steel bands efficiently secured.

5. (1) Where wood hatchway covers are fitted the hatchway beams are fore-and-afters shall be of the scantlings and spacing given in Table 1 in subparagraph (4) where coamings 24 inches high are required, and as given in Table 2 in subparagraph (5) where coamings 18 inches high are required.

Hatchway beams and fore-and-after.

(2) Angle bar mountings on the upper edge shall extend continuously for the full length of each beam.

(3) Wood fore-and-afters shall be steel shod at all bearing surfaces.

(4) Table 1 referred to in subparagraph (1) is—

**TABLE 1**

*(Coamings 24 inches in height)*

**HATCHWAY BEAMS AND FORE-AND-AFTERS FOR SHIPS 200 FEET OR MORE IN LENGTH\***

**HATCHWAY BEAMS**

Breadth of Hatchway	Mounting			Beams with Fore-and-Afters			Beams without Fore-and-Afters			
				Spacing Centre to Centre			Spacing Centre to Centre			
				6' 0"	8' 0"	10' 0"	4' 0"	5' 0"		
	Ins.	Ins.	Ins.	Ins.	Ins.	Ins.	Ins.	Ins.	Ins.	Ins.
10' 0"	3	x 3	x .40A	11 x .30P	12 x .32P	14 x .34P	9 x .46BP	10 x .50BP		
12' 0"	3	x 3	x .40A	12 x .32P	14 x .34P	17 x .36P	11 x .50BP	12 x .50BP		
14' 0"	3	x 3	x .42A	14 x .34P	17 x .36P	20 x .38P	12 x .50BP	12 x .32P		
16' 0"	3 1/2	x 3	x .42A	16 x .36P	19 x .38P	22 x .38P	12 x .32P	14 x .34P		
18' 0"	4	x 3	x .44A	18 x .36P	21 x .38P	25 x .40P	14 x .34P	16 x .36P		
20' 0"	4	x 3	x .44A	20 x .38P	24 x .40P	28 x .42P	15 x .34P	18 x .36P		
22' 0"	4 1/2	x 3	x .46A	22 x .38P	26 x .42P	30 x .44P	16 x .36P	19 x .36P		
24' 0"	5	x 3 1/2	x .46A	23 x .40P	28 x .42P	32 x .44P	17 x .36P	20 x .38P		
26' 0"	5 1/2	x 3 1/2	x .48A	24 x .40P	29 x .42P	34 x .46P	18 x .36P	21 x .38P		
28' 0"	6	x 3 1/2	x .50A	25 x .40P	31 x .44P	36 x .48P	19 x .38P	22 x .38P		
30' 0"	6	x 3 1/2	x .52A	26 x .42P	32 x .44P	38 x .48P	20 x .38P	23 x .40P		

LAWS OF TRINIDAD AND TOBAGO

MINISTRY OF THE ATTORNEY GENERAL AND LEGAL AFFAIRS

www.legalaffairs.gov.tt

580

Chap. 50:10

Shipping

[Subsidiary]

Shipping (Load Line) Regulations

TABLE 1—Continued

Fore-and-Afters

Length of Fore-and-Afters	Mounting			Bulb Plate Centre Fore-and-Afters						Bulb Angle Side Fore-and-Afters					
				Spacing Centre to Centre						Spacing Centre to Centre					
	3' 0"		4' 0"		5' 0"		3' 0"		4' 0"		5' 0"				
	Ins.	Ins.	Ins.	Ins.	Ins.	Ins.	Ins.	Ins.	Ins.	Ins.	Ins.	Ins.	Ins.	Ins.	Ins.
6' 0"	2 $\frac{1}{2}$ x 2 $\frac{1}{2}$ x .36	6 x .36	6 $\frac{1}{2}$ x .38	7 x .38	6 x 3 x .36	6 $\frac{1}{2}$ x 3 $\frac{1}{2}$ x .38	7 x 3 $\frac{1}{2}$ x .38	7 x 3 $\frac{1}{2}$ x .38	7 x 3 $\frac{1}{2}$ x .38	7 x 3 $\frac{1}{2}$ x .38	7 x 3 $\frac{1}{2}$ x .38	7 x 3 $\frac{1}{2}$ x .38	7 x 3 $\frac{1}{2}$ x .38	7 x 3 $\frac{1}{2}$ x .38	7 x 3 $\frac{1}{2}$ x .38
8' 0"	2 $\frac{1}{2}$ x 2 $\frac{1}{2}$ x .38	7 x .42	8 x .44	9 x .44	7 x 3 $\frac{1}{2}$ x .42	8 x 3 x .44	9 x 3 $\frac{1}{2}$ x .44	8 x 3 x .44	9 x 3 $\frac{1}{2}$ x .44	8 x 3 x .44	9 x 3 $\frac{1}{2}$ x .44	8 x 3 x .44	9 x 3 $\frac{1}{2}$ x .44	8 x 3 x .44	9 x 3 $\frac{1}{2}$ x .44
10' 0"	2 $\frac{1}{2}$ x 2 $\frac{1}{2}$ x .40	8 x .50	9 $\frac{1}{2}$ x .50	11 x .50	8 x 3 $\frac{1}{2}$ x .50	9 $\frac{1}{2}$ x 3 $\frac{1}{2}$ x .50	11 x 3 $\frac{1}{2}$ x .50	8 x 3 $\frac{1}{2}$ x .50	9 $\frac{1}{2}$ x 3 $\frac{1}{2}$ x .50	8 x 3 $\frac{1}{2}$ x .50	9 $\frac{1}{2}$ x 3 $\frac{1}{2}$ x .50	8 x 3 $\frac{1}{2}$ x .50	9 $\frac{1}{2}$ x 3 $\frac{1}{2}$ x .50	8 x 3 $\frac{1}{2}$ x .50	9 $\frac{1}{2}$ x 3 $\frac{1}{2}$ x .50
	Wood Centre Fore-and-Afters						Wood Side Fore-and-Afters								
	Spacing Centre to Centre						Spacing Centre to Centre								
	3' 0"		4' 0"		5' 0"		3' 0"		4' 0"		5' 0"				
	D	B	D	B	D	B	D	B	D	B	D	B			
	Ins.	Ins.	Ins.	Ins.	Ins.	Ins.	Ins.	Ins.	Ins.	Ins.	Ins.	Ins.			
6' 0"	5 $\frac{1}{2}$	7	6	7	6 $\frac{1}{2}$	7	5 $\frac{1}{2}$	5 $\frac{1}{2}$	6	6	6 $\frac{1}{2}$	6			
8' 0"	6 $\frac{1}{2}$	7	7 $\frac{1}{2}$	7	8	7	6 $\frac{1}{2}$	6 $\frac{1}{2}$	7 $\frac{1}{2}$	7	8	7			
10' 0"	8	7	8 $\frac{1}{2}$	8	9	9	8	7	8 $\frac{1}{2}$	8	9	9			

A—Plain angle. BP—Bulb plate. P—Plate. D—Depth. B—Breadth.

Depths for hatchway beams are at the middle of the length and are measured from the top mounting to the lower edge. Depths for fore-and-afters are measured from the under side of the hatch covers to the lower edge. Sizes for intermediate lengths and spacing are obtained by interpolation. Where plates are specified, two angles, of the size given for mountings, are to be fitted at the upper and at the lower part of the beam. Where bulb plates are specified, two angles, of the size given for mountings, are to be fitted at the upper part of the beam or fore-and-after. Where bulb angle are specified, one angle, of the size given for mountings, is to be fitted at the upper part of the section. Where specified flanges of an angle are of different dimension, the larger flange is to be horizontal.

\*In ships not exceeding 100 feet in length, the depths of beams which are formed of plates and angles may be 60 per cent of the depths given above; the depths of beams and steel fore-and afters formed of bulb angle or bulb plate section may be 80 per cent of the depths given above; the thickness of plates, bulb angles and bulb plates should correspond to the thickness tabulated for the reduced depths with a minimum thickness of .30 inch; the depths and breadths of wood fore-and-afters may be 80 per cent of those given in the tables for side fore-and-afters, but the centre fore-and-after must be not less than 6 $\frac{1}{2}$  inches wide. In ships between 100 feet and 200 feet in length, the sizes of the beams and fore-and-afters are to be determined by linear interpolation.

UNOFFICIAL VERSION

UPDATED TO 31ST DECEMBER 2016

(5) Table 2 referred to in subparagraph (1) is—

**TABLE 2**

*(Coamings 18 inches in height)*

**HATCHWAY BEAMS AND FORE-AND-AFTERS FOR SHIPS 200 FEET OR MORE IN LENGTH\***

**HATCHWAY BEAMS**

Breadth of Hatchway	Mounting			Beams with Fore-and-Afters						Beams without Fore-and-Afters	
				Spacing Centre to Centre						Spacing Centre to Centre	
				6' 0"		8' 0"		10' 0"		4' 0"	5' 0"
	Ins.	Ins.	Ins.	Ins.	Ins.	Ins.	Ins.	Ins.	Ins.	Ins.	
10' 0"	3	x 3	x .40A	9 <sup>1</sup> / <sub>2</sub> x .46BP	10 <sup>1</sup> / <sub>2</sub> x .50BP	11 <sup>1</sup> / <sub>2</sub> x .52BP	8 x .40BP	9 x .44BP			
12' 0"	3	x 3	x .40A	11 x .50BP	11 x .30P	13 x .34P	9 x .44BP	10 x .50BP			
14' 0"	3	x 3	x .42A	11 x .30P	13 x .32P	15 x .34P	10 x .50BP	11 <sup>1</sup> / <sub>2</sub> x .50BP			
16' 0"	3 <sup>1</sup> / <sub>2</sub>	x 3	x .42A	12 x .32P	15 x .34P	17 x .36P	11 x .30P	11 x .30P			
18' 0"	4	x 3	x .44A	14 x .34P	17 x .36P	19 x .38P	11 x .30P	12 x .32P			
20' 0"	4	x 3	x .44A	16 x .36P	19 x .38P	21 x .38P	12 x .32P	13 x .34P			
22' 0"	4 <sup>1</sup> / <sub>2</sub>	x 3	x .46A	17 x .36P	20 x .38P	23 x .40P	12 <sup>1</sup> / <sub>2</sub> x .32P	14 x .34P			
24' 0"	5	x 3 <sup>1</sup> / <sub>2</sub>	x .46A	18 x .36P	21 x .38P	25 x .40P	13 x .34P	14 <sup>1</sup> / <sub>2</sub> x .34P			
26' 0"	5 <sup>1</sup> / <sub>2</sub>	x 3 <sup>1</sup> / <sub>2</sub>	x .48A	19 x .38P	22 x .38P	26 x .42P	13 <sup>1</sup> / <sub>2</sub> x .34P	15 x .34P			
28' 0"	6	x 3 <sup>1</sup> / <sub>2</sub>	x .50A	20 x .38P	23 x .40P	27 x .42P	14 x .34P	16 x .36P			
30' 0"	6	x 3 <sup>1</sup> / <sub>2</sub>	x .52A	21 x .38P	24 x .40P	28 x .42P	15 x .34P	17 x .36P			

**Fore-and-Afters**

Length of Fore-and-Afters	Mounting			Bulb Plate Centre Fore-and-Afters						Bulb Angle Side Fore-and-Afters					
				Spacing Centre to Centre						Spacing Centre to Centre					
				3' 0"		4' 0"		5' 0"		3' 0"		4' 0"		5' 0"	
	Ins.	Ins.	Ins.	Ins.	Ins.	Ins.	Ins.	Ins.	Ins.	Ins.	Ins.	Ins.	Ins.	Ins.	
6' 0"	2 <sup>1</sup> / <sub>2</sub>	x 2 <sup>1</sup> / <sub>2</sub>	x .36	5 x .34	5 <sup>1</sup> / <sub>2</sub> x .34	6 x .36	5 x 3 x .34	5 <sup>1</sup> / <sub>2</sub> x 3 x .34	6 x 3 x .36						
8' 0"	2 <sup>1</sup> / <sub>2</sub>	x 2 <sup>1</sup> / <sub>2</sub>	x .38	6 x .38	7 x .40	7 <sup>1</sup> / <sub>2</sub> x .42	6 x 3 x .38	7 x 3 x .40	7 <sup>1</sup> / <sub>2</sub> x 3 <sup>1</sup> / <sub>2</sub> x .42						
10' 0"	2 <sup>1</sup> / <sub>2</sub>	x 2 <sup>1</sup> / <sub>2</sub>	x .40	7 x .44	8 x .46	9 x .50	7 x 3 x .44	8 x 3 <sup>1</sup> / <sub>2</sub> x .46	9 x 3 <sup>1</sup> / <sub>2</sub> x .50						

**LAWS OF TRINIDAD AND TOBAGO**

MINISTRY OF THE ATTORNEY GENERAL AND LEGAL AFFAIRS

www.legalaffairs.gov.tt

582

**Chap. 50:10**

*Shipping*

**[Subsidiary]**

*Shipping (Load Line) Regulations*

	Wood Centre Fore-and-Afters						Wood Side Fore-and-Afters					
	Spacing Centre to Centre						Spacing Centre to Centre					
	3' 0"		4' 0"		5' 0"		3' 0"		4' 0"		5' 0"	
	D	B	D	B	D	B	D	B	D	B	D	B
	Ins.	Ins.	Ins.	Ins.	Ins.	Ins.	Ins.	Ins.	Ins.	Ins.	Ins.	Ins.
6' 0"	5	7	5 <sup>1/2</sup>	7	6	7	5	5	5 <sup>1/2</sup>	5	6	5
8' 0"	6	7	6 <sup>1/2</sup>	7	7	7	6	5	6 <sup>1/2</sup>	6	7	6
10' 0"	7	7	7 <sup>1/2</sup>	7	8	7	7	6	7 <sup>1/2</sup>	7	8	7

A—Plain angle. BP—Bulb plate. P—Plate. D—Depth. B—Breadth.

Depths for hatchway beams are at the middle of the length and are measured from the top mounting to the lower edge. Depths for fore-and-afters are measured from the under side of the hatch covers to the lower edge. Sizes for intermediate lengths and spacing are obtained by interpolation. Where plates are specified, two angles, of the size given for mountings, are to be fitted at the upper and at the lower part of the beam. Where bulb plates are specified, two angles, of the size given for mountings, are to be fitted at the upper part of the beam or fore-and-after. Where bulb angles are specified, one angle, of the size given for mountings, is to be fitted at the upper part of the section. Where the specified flanges of an angle are of different dimensions, the larger flange is to be horizontal;

\*In ships not exceeding 100 feet in length, the depths of beams which are formed of plates and angles may be 60 per cent of the depths given above; the depths of beams and steel fore-and-afters formed of bulb angle or bulb plate section may be 80 per cent of the depths given above; the thickness of plates, bulb angles and bulb plates should correspond to the thickness tabulated for the reduced depths with a minimum thickness of .30 inch; the depths and breadths of wood fore-and-afters may be 80 per cent of those given in the tables for side fore-and-afters, but the centre fore-and-afters must be not less than 6<sup>1/2</sup> inches wide. In ships between 100 feet and 200 feet in length, the sizes of the beams and fore-and-afters are to be determined by linear interpolation.

Carriers or sockets.

6. Carriers or sockets for hatchway beams and fore-and-afters shall be of steel at least 1/2 inch thick, and shall have a width of bearing surface of at least 3 inches.

Cleats.

7. (1) Strong cleats at least 2 1/2 inches wide, shall be fitted at intervals of not more than 2 feet from centre to centre; the end cleats shall be placed not more than 6 inches from each corner of the hatchway.

(2) Cleats shall be of a pattern approved by the Assigning Authority and shall be set to fit the taper of the wedges.

Battens, wedges and tarpaulins.

8. (1) Battens and wedges shall be efficient and in good condition.

(2) Wedges shall be made from tough wood cut to a taper of 1 in 6 and shall be not less than 1/2 inch thick at the toe.

(3) At least two tarpaulins in good condition, thoroughly water-proofed and of ample strength, shall be provided for each hatchway in an exposed position on freeboard and superstructure decks.

(4) The material of the tarpaulins shall be guaranteed free from jute, and the minimum weight of the material, before treatment, shall be 19 ozs. per square yard if to be tarred, 18 ozs. per square yard if to be chemically dressed or 16 ozs. per square yard for black oil dressing.

UNOFFICIAL VERSION

UPDATED TO 31ST DECEMBER 2016

9. (1) Where the coamings are required to be 24 inches high, steel bars or other equivalent means shall be provided for efficiently and independently securing each section of hatchway covers after the tarpaulins are battened down.

Security of hatchway covers.

(2) At all other hatchways in exposed positions on freeboard and superstructure decks, ring bolts or other fittings for lashings shall be provided.

(3) Where the hatchway covers extend over intermediate supports, steel bars or their equivalent shall be fitted at each end of each section of the covers.

10. (1) Cargo, coamings and other hatchways in the freeboard deck within superstructures which are fitted with closing appliances less efficient than Class 1 but not less efficient than Class 2 shall have coamings at least 9 inches in height and closing arrangements as effective as those required for exposed cargo hatchways whose coamings are 18 inches high.

Hatchways, coamings and closing arrangements within superstructures.

(2) Where the closing appliances are less efficient than Class 2, the hatchways shall have coamings at least 18 inches in height, and shall have fittings and closing arrangements as effective as those required for exposed cargo hatchways.

11. (1) Machinery space openings in exposed positions on freeboard and raised quarterdecks shall be properly framed and efficiently enclosed by steel casings of ample strength.

Machinery space opening on freeboard and raised quarterdecks.

(2) The doors in casings referred to in subparagraph (1) shall be of steel, efficiently stiffened, permanently attached, and capable of being closed and secured from both sides.

(3) The sills of openings shall be at least 24 inches above the freeboard deck and at least 18 inches above the raised quarterdeck.

(4) Fiddley, funnel and ventilator coamings shall be as high above the deck as is reasonable and practicable.

(5) Fiddley openings shall have strong covers permanently attached in their proper positions.

12. (1) Machinery space openings in exposed positions on superstructure deck other than raised quarterdecks shall be properly framed and efficiently enclosed by strong steel casings.

Machinery space openings on superstructure decks other than raised quarterdecks.

(2) The doors in such casings shall be strongly constructed, permanently attached, and capable of being closed and secured from both sides.

(3) The sills of the openings shall be at least 15 inches above superstructure decks.

(4) Fiddley, funnel and ventilator coamings shall be as high above the deck as is reasonable and practicable.

LAWS OF TRINIDAD AND TOBAGO

MINISTRY OF THE ATTORNEY GENERAL AND LEGAL AFFAIRS

www.legalaffairs.gov.tt

584

Chap. 50:10

Shipping

[Subsidiary]

Shipping (Load Line) Regulations

(5) Fiddley openings shall have strong steel covers permanently attached in their proper positions.

Machinery  
space openings  
within  
superstructure.

13. (1) Machinery space openings in the freeboard deck within superstructures which are fitted with closing appliances less efficient than Class 1 shall be properly framed and efficiently enclosed by steel casings.

(2) The doors in such casings shall be strongly constructed, permanently attached and capable of being securely closed.

(3) The sills of the openings shall be at least 9 inches above the deck where the superstructures are closed by Class 2 closing appliances, and at least 15 inches above the deck where the closing appliances are less efficient than Class 2.

Flush  
bunker  
scuttles.

14. (1) Flush bunker scuttles may only be fitted in superstructure decks, except in the case of small ships in special trades when they may be fitted in other positions by permission of the Assigning Authority.

(2) Such scuttles shall be of iron or steel, of substantial construction, with screw or bayonet joints; where a scuttle is not secured by hinges, a permanent chain attachment shall be provided.

Companionways.

15. (1) Companionways in exposed positions on freeboard decks and on deck of enclosed superstructures shall be of substantial construction.

(2) The sills of the doorways shall be of the heights specified for hatchway coamings in paragraphs 3 and 10.

(3) The doors shall be strongly constructed and capable of being closed and secured from both sides.

(4) Where the companionway is situated within a quarter of the ship's length from the stem, it shall be of steel and riveted to the deck plating.

Ventilators.

16. (1) Ventilators in exposed positions on freeboard and superstructure decks to space below freeboard decks or decks of superstructures which are intact or fitted with Class 1 closing appliances shall have coamings of steel, substantially constructed, and efficiently connected to the deck by rivets spaced four diameters apart centre to centre, or by equally effective means.

(2) The deck plating at the base of the coaming shall be efficiently stiffened between the deck beams.

(3) The ventilator openings shall be provided with efficient closing arrangement.

(4) Where such ventilators are situated on the freeboard deck, or on the superstructure deck within a quarter of the ship's length from the stem, and the closing arrangements of the ventilators are of a temporary character, the coamings shall be at least 36 inches in height; in other exposed positions on the superstructure deck they are to be at least 30 inches in height.

UNOFFICIAL VERSION

UPDATED TO 31ST DECEMBER 2016

(5) Where the coaming of any ventilator exceeds 36 inches in height it shall be specially supported and secured.

17. (1) Where the air pipes to ballast and other tanks extend above freeboard or superstructure decks, the exposed parts of the pipes shall be of substantial construction. Air pipes.

(2) The height from the deck to the opening shall be at least 36 inches in wells on freeboard decks, 30 inches on raised quarterdecks, and 18 inches on other superstructure decks.

(3) Efficient means shall be provided for closing the openings of the air pipes.

*B—Openings in the sides of ships*

18. Openings in the sides of ships below the freeboard deck shall be fitted with watertight doors or covers which, with their securing appliances, shall be of sufficient strength. Gangway, cargo, coaling ports, etc.

19. (1) Discharges led through the ship's sides from spaces below the freeboard deck shall be fitted with efficient and accessible means for preventing water from passing inboard. Scuppers and sanitary discharge pipes.

(2) Each separate discharge shall have either an automatic non-return valve with a positive means of closing it from a position above the freeboard deck, or two automatic non-return valves without positive means of closing, provided the upper valve is situated so that it is always accessible for examination under service conditions.

(3) The positive action valve shall be readily accessible and is to be provided with means for showing whether the valve is opened or closed.

(4) Subparagraphs (1) to (3) shall apply to discharges from spaces within enclosed superstructures if, and to the extent that, the Assigning Authority consider necessary having regard to the type and location of the inboard ends of each openings.

(5) Where scuppers are fitted in superstructures not fitted with Class 1 closing appliances, they shall have efficient means for preventing the accidental admission of water below the freeboard deck.

(6) Cast iron shall not be accepted for valve and discharges led through the ship's sides below the freeboard deck or through the sides of enclosed superstructures.

20. (1) Side scuttles to spaces below the freeboard deck, or to spaces below the superstructure deck of superstructures closed by Class 1 or Class 2 closing appliances, shall be fitted with efficient inside deadlights permanently attached in their proper positions so that they can be effectively closed and secured watertight. Side scuttles.

**LAWS OF TRINIDAD AND TOBAGO**

MINISTRY OF THE ATTORNEY GENERAL AND LEGAL AFFAIRS

www.legalaffairs.gov.tt

586

**Chap. 50:10**

*Shipping*

**[Subsidiary]**

*Shipping (Load Line) Regulations*

(2) Where, however, such spaces in superstructures are appropriated to passengers, other than steerage passengers, or to crew, the side scuttles may have portable deadlights stowed adjacent to the side scuttles, provided they are readily accessible at all times in service.

(3) The side scuttles and deadlight shall be of substantial construction and of types approved by the Minister.

*C—Miscellaneous Provisions*

Guard rails. 21. Efficient guard rails or bulwarks shall be fitted on all exposed portions of freeboard and superstructure decks.

Freeing ports. 22. (1) Where bulwarks on the weather portions of freeboard or superstructure decks form “wells”, ample provision shall be made for rapidly freeing the decks of water and for draining them.

(2) The minimum freeing port area on each side of the ship for each “well” on freeboard decks and on raised quarterdecks shall be that given by the scale given in subparagraph (6).

(3) The minimum area for each well on any superstructure deck other than a raised quarterdeck shall be one-half the area given by that scale.

(4) Where the length of the well exceeds seven-tenths of the length of the ship as defined in paragraph 26, the Assigning Authority may modify that scale.

(5) In ships with less than the standard sheer the freeing port area shall be increased as required by the Assigning Authority.

(6) The scale referred to in subparagraphs (3) and (4) is—

**SCALE OF FREEING PORT AREA**

Length of Bulwarks in “Well” in Feet	Freeing Port Area on each side in Square Feet
15	8.0
20	8.5
25	9.0
30	9.5
35	10.0
40	10.5
45	11.0
50	11.5
55	12.0
60	12.5
65	13.0
Above 65	1 square foot for each additional 5 feet length of bulwarks.

UNOFFICIAL VERSION

UPDATED TO 31ST DECEMBER 2016

(7) The lower edges of the freeing ports shall be as near the deck as practicable and as a general rule shall not be higher than the upper edge of the gunwale bar.

(8) Two-thirds of the freeing port area required shall be provided in the midship half of the well.

(9) All openings in the bulwarks shall be protected by rails or bars spaced about 9 inches apart.

(10) Where shutters are fitted to freeing ports, ample clearance shall be provided to prevent jamming and hinges shall have brass pins.

23. (1) Gangways, lifelines or other satisfactory means shall be provided for the protection of the crew in getting to and from their quarters. Protection of crew.

(2) The strength of houses for the accommodation of crew on flush deck steamers shall be equivalent to that requirement for superstructure bulkheads.

24. Notwithstanding anything in paragraphs 2 to 23 the Assigning Authority may, in any exceptional case, allow departures from the said provisions on condition that the freeboards computed for the ship are increased to such extent as will, in the opinion of the Minister, ensure that the protection afforded to the ship and crew is not less effective than it would be if the ship fully complied with paragraphs 2 to 23 and there had been no increase of freeboards. Special provision for exceptional ships.

### PART III

## COMPUTATION OF FREEBOARDS FOR STEAMERS

### *A—General*

25. Subject to paragraph 24 the freeboards for steamers, other than tankers or steamers of special type to which freeboards are assigned under Parts VI and VII shall be computed in accordance with this Part. Freeboards for steamers.

26. (1) The length (L) to be used with this Schedule is the length in feet on the summer load water-line from the foreside of the stem to the after side of the rudder post. Length.

(2) Where there is no rudder post, the length is measured from the foreside of the stem to the axis of the rudder stock.

(3) For ships with cruiser sterns, the length shall be taken as 96 per cent of the total length on the designed summer load water-line or as the length from the foreside of the stem to the axis of the rudder stock if that is greater.

27. The breadth (B) to be used with this Schedule is the maximum breadth in feet amidships to the moulded line of the frame in iron or steel ships, and to the outside of the planking in wood or composite ships. Breadth.

LAWS OF TRINIDAD AND TOBAGO

MINISTRY OF THE ATTORNEY GENERAL AND LEGAL AFFAIRS

www.legalaffairs.gov.tt

588

Chap. 50:10

Shipping

[Subsidiary]

Shipping (Load Line) Regulations

Moulded depth. 28. (1) The moulded depth is the vertical distance in feet, measured amidships, from the top of the keel to the top of the freeboard deck beam at side.

(2) In wood and composite ships the vertical distance referred to in subparagraph (1) is measured from the lower edge of the keel rabbet.

(3) Where the form at the lower part of the midship section is of a hollow character, or where thick garboards are fitted, the depth is measured from the point where the line of the flat of the bottom continued inwards cuts the side of the keel.

Depth for freeboard. 29. (1) The depth (D) to be used with this Schedule is the moulded depth plus the thickness of stringer plate, or plus  $\frac{T(L-S)}{L}$  if that is greater, where—

(a) T is the mean thickness of the exposed deck clear of deck openings; and

(b) S is the total length of superstructures as defined in paragraph 34.

(2) Where the topsides are of unusual form, D is the depth of a midship section having vertical topsides, standard round of beam and area of topside section equal to that in the actual midship section.

(3) Where there is a step or break in the topsides (e.g., as in the Turret Deck ship) 70 per cent of the area above the step or break is included in the area used to determine the equivalent section.

(4) In a ship without an enclosed superstructure covering at least 0.6 L amidships, without a complete trunk or without a combination of intact partial superstructures and trunk extending all fore and aft, where D is less than  $\frac{(L)}{15}$ , the depth used with the Table set out in paragraph 62 shall not be taken as less than  $\frac{(L)}{15}$ .

Coefficient of fineness. 30. (1) The coefficient of fineness (c) to be used with this Schedule is given by the formula—

$$c = \frac{35 \Delta}{L.B.d_1}$$

where  $\Delta$  is the ship's moulded displacement in tons (excluding bossing) at a mean moulded draught  $d_1$  which is 85 per cent of the moulded depth.

(2) The coefficient (c) shall not be taken as less than 0.68.

UNOFFICIAL VERSION

UPDATED TO 31ST DECEMBER 2016

*B—Scantlings*

31. (1) The Assigning Authority shall be satisfied with the structural strength of any ship before assigning to it a freeboard. Strength of ship.

(2) Ships which comply with the highest standard of rules of a Classification Society recognised for this purpose by the Minister shall be regarded as having sufficient strength for the minimum freeboards allowed under this Schedule.

(3) Ships which do not comply with the highest standard of the rules of a Classification Society recognised as aforesaid shall be assigned such increased freeboards as shall be determined by the Assigning Authority, having regard to the extent to which the ship complies with the following strength moduli:

(a) material:

- (i) the strength moduli are based on the assumption that the structure is built of mild steel, manufactured by the open hearth process (acid or basic), and having a tensile strength of 26 to 32 tons per square inch, and an elongation of at least 16 per cent on a length of 8 inches;
- (ii) Strength Deck—The strength deck is the uppermost deck which is incorporated into and forms an integral part of the longitudinal girder within the half-length amidships;
- (iii) Depth to Strength Deck (Ds)—The depth to strength deck is the vertical distance in feet amidships from the top of the keel to the top of the strength deck beam at side;
- (iv) Draught (d)—The draught is the vertical distance in feet amidships from the top of the keel to the centre of the load line disc;

(b) longitudinal modulus:

- (i) the longitudinal modulus  $\frac{I}{y}$  is the moment of inertia *I* of the midship section about the neutral axis divided by the distance *y* measured from the central axis to the top of the strength deck beam at side, calculated in way of openings but without deductions for rivet holes; areas are measured in square inches and distances in feet;
- (ii) below the strength deck, all continuous longitudinal members other than such parts of the under deck girders as are required entirely for supporting purposes, are included; above the strength deck, the gunwale angle bar and the extension of the sheerstrake are the only members included;

**LAWS OF TRINIDAD AND TOBAGO**

MINISTRY OF THE ATTORNEY GENERAL AND LEGAL AFFAIRS

www.legalaffairs.gov.tt

590

**Chap. 50:10**

*Shipping*

**[Subsidiary]**

*Shipping (Load Line) Regulations*

- (iii) the required longitudinal modulus for effective material is expressed by the formula  $f(d)(B)$ , where  $f$  is the factor obtained from the following table:

L.	f.	L.	f.
100	1.80	360	9.40
120	2.00	380	10.30
140	2.35	400	11.20
160	2.70	420	12.15
180	3.15	440	13.10
200	3.60	460	14.15
220	4.20	480	15.15
240	4.80	500	16.25
260	5.45	520	17.35
280	6.20	540	18.45
300	6.95	560	19.60
320	7.70	580	20.80
340	8.55	600	22.00

- (iv) for intermediate lengths, the value of  $f$  is determined by interpolation;
- (v) this formula applies where  $L$  does not exceed 600 feet,

$B$  is between  $\frac{L}{10} + 5$  and  $\frac{L}{10} + 20$ , both inclusive, and

$\frac{L}{D}$  is between 10 and 13.5, both inclusive;

- (c) Frame modulus;

- (i) for the purpose of the frame modulus, the frame is regarded as composed of a frame angle and a reverse angle each of the same size and thickness;
- (ii) The modulus  $\frac{I}{Y}$  of the midship frame below the lowest tier of beams is the moment of inertia  $I$  of the frame section about the neutral axis divided by the distance  $y$  measured from the neutral axis to the extremity of the frame section, calculated without deduction for rivet and bolt holes; the modulus is measured in inch units;
- (iii) the required frame modulus is expressed by the formula:

$$\frac{s(d-t)(f_1 + f_2)}{1,000}$$

UNOFFICIAL VERSION

UPDATED TO 31ST DECEMBER 2016

where—

s is the frame spacing in inches; t is the vertical distance in feet measured at amidships from the top of the keel to a point midway between the top of the inner bottom at side and top of the heel bracket in accordance with figure 1 in sub-item (vii); where there is no double bottom, t is measured to a point midway between the top of the floor at centre and the top of the floor at side;

f<sub>1</sub> is a coefficient depending on H, which, in ships fitted with double bottoms, is the vertical distance in feet from the middle of the beam bracket of the lowest tier of beams at side to a point midway between the top of the inner bottom at side and the top of the heel bracket in accordance with figure 1 of sub-item (vii) where there is no double bottom, H is measured to a point midway between the top of the floor at centre and the top of the floor at side; where the frame obtains additional strength from the form of the ship, due allowance is made in the value of f<sub>1</sub>;

f<sub>2</sub> is a coefficient depending on K, which is the vertical distance in feet from the top of the lowest tier of beams at side to a point 7 feet 6 inches above the freeboard deck at side, or, if there is a superstructure, to a point 12 feet 6 inches above the freeboard deck at side in accordance with figure 1 of sub-item (vii);

H in feet	0	7	9	11	13	15	17	19	21	23	25
f <sub>1</sub>	9	11	12.5	15	19	24	29.5	36	43	51	59
K in feet	0	5	10	15	20	25	30	35	40		
f <sub>2</sub>	0	0.5	1.0	2.0	3.0	4.5	6.5	9.0	12.0		

(iv) the values of f<sub>1</sub> and f<sub>2</sub> are obtained from the following Tables and intermediate values are obtained by interpolation;

(v) this formula applies where d is between 15 feet and 60 feet, both inclusive, B is between  $\frac{L}{10} + 5$  and  $\frac{L}{10} + 20$ ,

both inclusive,  $\frac{L}{D_s}$  is between 10 and 13.5, both

LAWS OF TRINIDAD AND TOBAGO

MINISTRY OF THE ATTORNEY GENERAL AND LEGAL AFFAIRS

www.legalaffairs.gov.tt

592

Chap. 50:10

Shipping

[Subsidiary]

Shipping (Load Line) Regulations

inclusive, and the horizontal distance from the outside of the frame to the centre of the first row of pillars does not exceed 20 feet;

- (vi) in single deck ships of ordinary form, where H does not exceed 18 feet, the frame modulus determined by the preceding method is multiplied by the factor  $f_3$  where—

$$f_3 = .50 + .05(H-8);$$

- (vii) where the horizontal distance from the outside of the frame to the centre of the first row of pillars exceeds 20 feet, sufficient additional strength shall be provided to the satisfaction of the Assigning Authority.

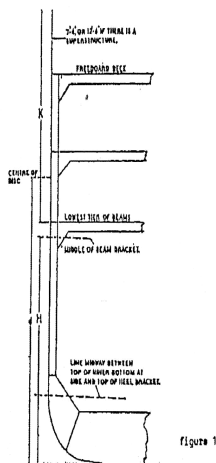

UNOFFICIAL VERSION

UPDATED TO 31ST DECEMBER 2016

**TABLE OF SCANTLINGS**

*Exposed Bulkheads of Superstructures of Standard Height*

Bridge Front Bulkheads Unprotected Bulkheads of Poops .4 L or more in Length		Bulkheads of Poops Partially Protected or less in Length than .4 L		After Bulkheads of Bridges and Forecasts	
Length of Ship	Bulb Angle Stiffeners	Length of Ship	Plain Angle Stiffeners	Length of Ship	Plain Angle Stiffeners
Feet	Inches	Feet	Inches	Feet	Inches
Under 160	5½ x 3 x .30	Under 150	3 x 2½ x .30	Under 150	2½ x 2½ x .26
160	6 x 3 x .32	150	3½ x 2½ x .32	150	3 x 2½ x .28
200	6½ x 3 x .34	200	4 x 3 x .34	250	3½ x 3 x .30
240	7 x 3 x .36	250	4½ x 3 x .36	350	4 x 3 x .32
280	7½ x 3 x .38	300	5 x 3 x .38		
320	8 x 3 x .40	350	5½ x 3 x .42		
360	8½ x 3 x .42	400	6 x 3 x .44		
400	9 x 3 x .44	450	6½ x 3½ x .46		
440	9½ x 3½ x .46	500	7 x 3½ x .48		
480	10 x 3½ x .48	550	7 x 3½ x .50		
520	10½ x 3½ x .50				
560	11 x 3½ x .52				

Length of Ship	Bulkhead Plating	Length of Ship	Bulkhead Plating	Length of Ship	Bulkhead Plating
Feet	Inch	Feet	Inch	Feet	Inch
200		160		160	
and under	.3	and under	.24	and under	.20
380		400		400	
and above	.44	and above	.38	and above	.30

For ships intermediate in length the thickness of bulkhead plating are obtained by interpolation.

*C—Superstructures*

32. The height of a superstructure is the least vertical height measured from the top of the superstructure deck to the top of the freeboard deck beams minus the difference between D and the moulded depth as described in paragraphs 28 and 29. Height of superstructure.

LAWS OF TRINIDAD AND TOBAGO

MINISTRY OF THE ATTORNEY GENERAL AND LEGAL AFFAIRS

www.legalaffairs.gov.tt

594

Chap. 50:10

Shipping

[Subsidiary]

Shipping (Load Line) Regulations

Standard height of superstructure or of a trunk.

33. (1) The standard height of a raised quarterdeck is 3 feet for ships up to an including 100 feet in length, 4 feet for ships 250 feet in length and 6 feet for ships 400 feet in length and more.

(2) The standard height of any other superstructure or of a trunk is 6 feet for ships up to and including 250 feet in length and 7 feet 6 inches for ships 400 feet in length and more.

(3) The standard height at intermediate lengths is obtained by interpolation.

Length of superstructures.

34. The length of a superstructure (S) is the mean covered length of the parts of the superstructure which extend to the sides of the ship and lie within lines drawn perpendicular to the extremities of the summer load waterline, as described in paragraph 26.

Enclosed superstructure.

35. A detached superstructure is regarded as enclosed only where—

- (a) the enclosing bulkheads are of efficient construction as required by paragraph 36;
- (b) the access openings in these bulkheads are fitted with Class 1 or Class 2 closing appliances, as described in paragraphs 37 and 38;
- (c) all other openings in sides or ends of the superstructure are fitted with efficient weathertight means of closing; and
- (d) independent means of access to crew, machinery, bunker and other working spaces within bridges and poops are at all times available when the bulkhead openings are closed.

Superstructure bulkheads.

36. Bulkheads at exposed ends of poops, bridges and forecastles are deemed to be efficient construction where the Assigning Authority are satisfied that, in the circumstances, they are equivalent to the following standard for ships with minimum freeboards, under which standard the stiffeners and plating are of the scantlings given in the following Table, the stiffeners are spaced 30 inches apart, the stiffeners on poop and bridge front bulkheads have efficient end connections, and those on after bulkheads of bridges and forecastles extend for the whole distance between the margin angles of the bulkheads.

*D—Appliances for closing access opening in bulkheads at ends of detached superstructures*

Class 1 closing appliances.

37. Class 1 closing appliances shall be closing appliances which comply with the following conditions:

- (a) they shall be constructed of iron or steel;
- (b) they shall in all cases be permanently and strongly attached to the bulkhead;

UNOFFICIAL VERSION

UPDATED TO 31ST DECEMBER 2016

- (c) they shall be framed, stiffened and fitted so that the whole structure is of equivalent strength to the unpierced bulkhead;
- (d) they shall be weathertight when closed;
- (e) the means for securing these appliances shall be permanently attached to the bulkhead or to the appliances and the latter shall be so arranged that they can be closed and secured from both sides of the bulkhead or from the deck above; and
- (f) the sills of the access openings shall be at least 15 inches above the deck.

38. The following closing appliances shall be Class 2 closing appliances: Class 2 closing appliances.

- (a) strongly framed hardwood hinged doors, which are not more than 30 inches wide or less than 2 inches thick;
- (b) shifting boards fitted for the full height of the opening in channels rivetted to the bulkheads, the shifting boards being at least 2 inches thick when the width of opening is 30 inches or less, and increased in thickness at the rate of 1 inch for each additional 15 inches of width; or
- (c) portable plates of equal efficiency with the appliances specified in (a) or (b).

*E—Temporary appliances for closing openings in superstructure decks*

39. Temporary closing appliances for middle line openings in the deck of an enclosed superstructure shall be regarded as efficient if they consist of— Temporary closing appliances.

- (a) a steel coaming not less than 9 inches in height efficiently rivetted to the deck;
- (b) hatchway covers as required by paragraph 4, secured by hemp lashings; and
- (c) hatchway supports as required by paragraphs 5 and 6 and Table 1 or 2 in paragraph 5.

40. For the purpose of determining the effective length of detached superstructures paragraphs 41 to 46 shall apply. Determining effective length.

41. (1) Where exposed bulkheads at the end of poops, bridges and forecastles are not of efficient construction in accordance with paragraph 36 they shall be treated as non-existent. General.

(2) Where in the side plating of a superstructure there is an opening not provided with permanent means of closing, the part of the superstructure in way of the opening shall be regarded as having no effective length.

LAWS OF TRINIDAD AND TOBAGO

MINISTRY OF THE ATTORNEY GENERAL AND LEGAL AFFAIRS

www.legalaffairs.gov.tt

596

Chap. 50:10

Shipping

[Subsidiary]

Shipping (Load Line) Regulations

(3) Where the height of a superstructure is less than standard, its length shall be reduced in the ratio of the actual to the standard height; where the height exceeds the standard, no increase shall be made in the length of the superstructure.

Poop.

42. (1) Where there is an efficient bulkhead and the access openings are fitted with Class 1 closing appliances, the length of the poop to the bulkhead shall be the effective length.

(2) Where the access openings in an efficient bulkhead are fitted with Class 2 closing appliances and the length of the poop to the bulkhead is 5 L or less, 100 per cent of that length shall be the effective length; where the length is 0.7 L or more, 90 per cent of that length shall be the effective length; where the length is between 0.5 L and 0.7 L an intermediate percentage of that length shall be the effective length; but where in any of these cases an allowance is given for an efficient adjacent trunk in accordance with paragraph 46 only 90 per cent of the length to the bulkhead shall be the effective length.

(3) 50 per cent of the length of an open poop or of an open extension of a poop beyond an efficient bulkhead shall be the effective length of the open poop or of the extension, as the case may be.

Raised  
quarterdeck.

43. Where there is an efficient intact bulkhead, the length of the raised quarter deck to the bulkhead shall be the effective length; where the bulkhead is not intact, the superstructure shall be regarded as a poop of less than standard height.

Bridge.

44. (1) Where there is an efficient bulkhead at each end of the bridge and the access openings in the bulkheads are fitted with Class 1 closing appliances, the length between the bulkheads shall be the effective length.

(2) Where the access openings in the forward bulkhead are fitted with Class 1 closing appliances and the access openings in the after bulkhead with Class 2 closing appliances, the length between the bulkheads shall be the effective length; but where an allowance is given for an efficient trunk adjacent to the after bulkhead in accordance with paragraph 46, 90 per cent of the length shall be the effective length; where the access openings in both bulkheads are fitted with Class 2 closing appliances, 90 per cent of the length between the bulkheads shall be the effective length; where the access openings in the forward bulkhead are fitted with Class 1 or Class 2 closing appliances and the access openings in the after bulkhead have no closing appliances, 75 per cent of the length between the bulkhead shall be the effective length; where the access openings in both bulkheads have no closing appliances, 50 per cent of the length shall be the effective length.

(3) 75 per cent of the length of an open extension beyond the after bulkhead, and 50 per cent of that beyond the forward bulkhead, shall be the effective length.

UNOFFICIAL VERSION

UPDATED TO 31ST DECEMBER 2016

45. (1) Where there is an efficient bulkhead and the access openings are fitted with Class 1 or Class 2 closing appliances, the length of the forecastle to the bulkhead shall be the effective length; where no closing appliances are fitted and the sheer forward of amidships is not less than the standard sheer, 100 per cent of the length of the forecastle forward of 0.1 L from the forward perpendicular shall be the effective length. Forecastle.

(2) Where the sheer forward is half the standard sheer or less, 50 per cent of the length shall be the effective length; and where the sheer forward is intermediate between the standard and half the standard sheer, an intermediate percentage of that length shall be the effective length.

(3) 50 per cent of the length of an open extension beyond the bulkhead or beyond 0.1 L from the forward perpendicular shall be the effective length.

46. (1) A trunk or similar structure which does not extend to the sides of the ship shall be regarded as efficient where— Trunk.

- (a) the trunk is at least as strong as a superstructure;
- (b) the hatchways are in the trunk deck and comply with the requirements of paragraphs 2 to 9 and the width of the trunk deck stringer provides a satisfactory gangway and sufficient lateral stiffness;
- (c) a permanent working platform fore and aft fitted with guard rails is provided by the trunk deck or by detached trunks connected to other superstructures by efficient permanent gangway;
- (d) ventilators are protected by the trunk, by watertight covers or by equivalent means;
- (e) open rails are fitted on the weather portions of the freeboard deck in way of the trunk for at least half their length;
- (f) the machinery casings are protected by the trunk, by a superstructure of standard height, or by a deck house of the same height and of equivalent strength.

(2) Where access openings in poop and bridge bulkheads are fitted with Class 1 closing appliances, 100 per cent of the length of an efficient trunk reduced in the ratio of its mean breadth to (B) (as described in paragraph 27) shall be added to the effective length of the superstructure; where the access openings in these bulkheads are not fitted with Class 1 closing appliances 90 per cent of the length reduced as above shall be added.

(3) Where the height of the trunk is less than the standard height as determined in accordance with paragraph 33, the addition referred to in subparagraph (2) shall be reduced in the ratio of the actual to the standard height;

LAWS OF TRINIDAD AND TOBAGO

where the height of hatchway coamings on the trunk deck is less than the height of coamings required by paragraph 3, a reduction from the actual height of trunk shall be made corresponding to the difference between the actual height of the coamings and the height required by paragraph 3.

G—Effective length of enclosed superstructures with middle line openings

Enclosed superstructures having middle line openings, without permanent means of closing.

47. Where there is an enclosed superstructure with one or more middle line openings in the deck not provided with permanent means of closing in accordance with paragraphs 2 to 9 the effective length of the superstructure is determined as follows:

- (a) where efficient temporary closing appliances are not provided for the middle line deck openings in accordance with paragraph 39 or the breadth of opening is 80 per cent or more of the breadth (B) of the superstructure deck at the middle of the opening, the ship shall be regarded as having an open well in way of each opening, and freeing ports shall be provided in way of this well, the effective length of superstructure between openings shall be ascertained by applying paragraphs 41, 44 and 45;
- (b) where efficient temporary closing appliances as defined in paragraph 39 are provided for middle line deck openings and the breadth of opening is less than 0.8 B, the effective length of superstructure between openings shall be ascertained by applying paragraphs 42, 44 and 45, except that where access openings in 'tween deck bulkheads are closed by Class 2 closing appliances, they shall be regarded as being closed by Class 1 closing appliances; the total effective length shall be obtained by adding to the length thus determined the difference between that length and the length of the ship, modified in the ratio of—

$$\frac{B - b}{B_1} \text{ where } b = \text{breadth of deck}$$

opening; where  $\frac{B - b}{B_1}$  is greater than .5 it

is taken as .5.

H—Deductions For Superstructure

Deductions.

48. Where the effective length of superstructures is 1.0 L, the deduction from the freeboard shall be 14 inches at 80 feet length of ship, 34 inches at 280 feet length, and 42 inches at 400 feet length and above; deductions at intermediate

lengths shall be obtained by interpolation, where the total effective length of superstructures is less than 1.0 L, the deductions shall be a percentage obtained from the following Table:

Total Effective Length of Superstructure

Super-structures	Line										
	0	.1L	.2L	.3L	.4L	.5L	.6L	.7L	.8L	.9L	1.0 L
	Per cent	Per cent	Per cent	Per cent	Per cent	Per cent	Per cent	Per cent	Per cent	Per cent	Per cent
All types with fore-castle and without detached bridge	0	5	10	15	23.5	32	46	63	75.3	87.7	100 A
All types with fore-castle and detached bridge*	0	6.3	12.7	19	27.5	36	46	63	75.3	87.7	100 B

\*Where the effective length of a detached bridge is less than .2L the percentages are obtained by interpolation between lines B and A.

Where no fore-castle is fitted the above percentages are deducted by 5.

Percentages for intermediate lengths of superstructures are obtained by interpolation.

*I—Sheer*

49. (1) The sheer shall be measured from the deck at side to a line of General reference drawn parallel to the keel through the sheer line at amidships.

(2) In flush deck ships and in ships with detached superstructures the sheer shall be measured at the freeboard deck.

(3) In ships with topsides of unusual form in which there is a step or break in the topsides, the sheer shall be considered in relation to the equivalent depths amidships determined in accordance with paragraph 29.

(4) In ships with a superstructure of standard height which extends over the whole length of the freeboard deck, the sheer shall be measured at the superstructure deck; where the height exceeds the standard, the sheer may be considered in relation to the standard height.

**LAWS OF TRINIDAD AND TOBAGO**

MINISTRY OF THE ATTORNEY GENERAL AND LEGAL AFFAIRS

www.legalaffairs.gov.tt

600

**Chap. 50:10**

*Shipping*

**[Subsidiary]**

*Shipping (Load Line) Regulations*

(5) Where the superstructure is intact or access openings in its enclosing bulkheads are fitted with Class I closing appliances, and the superstructure deck has at least the same sheer as the exposed freeboard deck, the sheer of the enclosed portion of the freeboard deck shall not be taken into account.

Standard sheer profile.

50. The ordinates (in inches ) of the standard sheer profile are given in the following Table, where L is the number of feet in the length of the ship:

Station	Ordinate	Factor
A.P .	.1L + 10	1
1/6 from A.P .	.0445 L + 4.45	4
1/3 from A.P.	.011L + 1.1	2
Amidships	0	4
1/3 L from F.P.	.022 L + 2.2	2
1/6 L from F.P.	.089L + 8.9	4
F.P	.2L + 20	1

A.P. = After end of summer load waterline. F.P. = Fore end of summer load waterline.

Measurement of variations from standard sheer profile.

51. (1) Where the sheer profile differs from the standard, the seven ordinates of each profile shall be multiplied by the appropriate factors given in the table of ordinates in paragraph 50. The difference between the sums of the respective products, divided by 18, measures the deficiency or excess of sheer.

(2) Where the after half of the sheer profile is greater than the standard and the forward half is less than the standard, no credit shall be allowed for the part in excess.

(3) Where the forward half of the sheer profile exceeds the standard, and the after portion of the sheer profile is not less than 75 per cent of the standard, credit shall be allowed for the part in excess; where the after part is less than 50 per cent of the standard no credit shall be given for the excess sheer forward and where the after sheer is between 50 per cent and 75 per cent of the standard, an intermediate allowance may be granted for excess sheer forward.

Correction for variations from standard sheer profile.

52. The correction for sheer shall be the deficiency or excess of sheer determined in accordance with paragraph 51 multiplied by  $.75 - \frac{S}{2L}$ , where S is the total length of superstructure, as described in paragraph 34.

Addition for deficiency in sheer.

53. Where the sheer is less than the standard, the correction for deficiency in sheer, determined in accordance with paragraph 52, shall be added to the freeboard.

UNOFFICIAL VERSION

UPDATED TO 31ST DECEMBER 2016

54. In flush deck ships and in ships where an enclosed superstructure covers 0.1 L before and 0.1 L abaft amidships, the correction for excess of sheer determined in accordance with paragraph 52 shall be deducted from the freeboard; in ships with detached superstructures where no enclosed superstructure covers amidships, no deduction shall be made from the freeboard; where an enclosed superstructure covers less than 0.1 L before and 0.1 L abaft amidships, the deduction shall be obtained by interpolation, the maximum deduction for excess sheer shall be 1½ inches at 100 feet length of ship and shall increase at the rate of 1½ inches for each additional 100 feet in the length of the ship.

Deduction for excess sheer.

*J—Round of Beam*

55. The standard round of beam of the freeboard deck is 1/50 of the breadth of the ship.

Standard round of beam.

56. Where the round of beam of the freeboard deck is greater or less than the standard, the freeboard shall be decreased or increased respectively by ¼ of the difference between the actual and the standard round of beam, multiply by the proportion of the length of the freeboard deck not covered by enclosed superstructures; twice the standard round of beam is the maximum for which allowance may be given.

Variation of freeboard.

*K—Minimum Freeboard*

57. The minimum freeboard in summer shall be the freeboard derived from the Freeboard Table set out in paragraph 62 after correction for departures from the standards and after deduction for superstructures in accordance with this Schedule so however that if the freeboard, calculated in accordance with this Schedule but before the correction required by paragraph 62(e) is made, is less than two inches, two inches shall be substituted therefor.

Summer freeboard.

58. The minimum freeboard in the Tropical Zone shall be the freeboard obtained by a deduction from the Summer freeboard of ¼ inch per foot of Summer draught measured from the top of the keel to the centre of the load line disc, so however that if the freeboard, calculated in accordance with this Schedule but before the correction required by paragraph 62 (e) is made, is less than two inches, two inches shall be substituted therefor.

Tropical freeboard.

59. The minimum freeboard in Winter shall be the freeboard obtained by an addition to the Summer freeboard of ¼ inch per foot of Summer draught, measured from the top of the keel to the centre of the load line disc.

Winter freeboard.

60. The minimum winter North Atlantic freeboard for steamers not exceeding 330 feet in length shall be the winter freeboard plus two inches; for steamers over 330 feet in length the minimum winter North Atlantic freeboard shall be the Winter freeboard.

Winter North Atlantic freeboard.

**LAWS OF TRINIDAD AND TOBAGO**

MINISTRY OF THE ATTORNEY GENERAL AND LEGAL AFFAIRS

www.legalaffairs.gov.tt

602

**Chap. 50:10**

*Shipping*

**[Subsidiary]**

*Shipping (Load Line) Regulations*

Fresh water freeboard.

61. The minimum freeboard in fresh water of unit density shall be the freeboard obtained by deducting from the minimum freeboard in salt water

$\frac{\Delta}{40 T}$  inches, where

$\Delta$  = displacement in salt water in tons at the summer load waterline, and

T = tons per inch immersion in salt water at the summer load waterline.

Where the displacement at the summer load waterline cannot be determined, the deduction shall be  $\frac{1}{4}$  inch per foot of summer draught measured from the top of the keel to the centre of the disc.

Freeboard table for steamers.

62. Basic Minimum Summer freeboards for Steamers which comply with the Standards laid down in this Schedule are as follows:

L	Freeboard	L	Freeboard	L	Freeboard	L	Freeboard
Feet	Inches	Feet	Inches	Feet	Inches	Feet	Inches
80	8.0	250	32.3	430	77.0	580	127.0
90	9.0	200	34.4	430	80.9	600	129.6
100	10.0	270	36.5	440	84.0	610	132.0
110	11.0	280	36.7	450	87.1	620	134.4
120	12.0	190	41.0	460	90.2	630	136.0
130	13.0	300	43.4	470	93.3	640	139.1
140	14.2	310	45.9	480	96.3	650	141.4
150	15.9	320	56.0	490	99.3	600	143.7
160	16.9	330	51.0	500	102.3	670	145.9
170	18.8	340	53.7	510	105.2	680	148.1
180	19.8	350	56.5	520	106.1	690	150.1
190	21.4	360	59.4	530	110.9	700	152.3
200	23.1	370	62.4	540	113.7	710	154.4
210	24.8	300	65.4	550	116.4	720	156.4
220	26.6	390	68.4	560	119.1	730	158.5
230	28.5	400	71.5	570	121.0	740	160.5
240	30.3	410	74.6	580	124.4	750	162.5

(a) the minimum freeboard for flush deck steamers shall be obtained by an addition to the above Table at the rate of  $1\frac{1}{2}$  inches for every 100 feet of length;

(b) the freeboards at intermediate lengths shall be obtained by interpolation;

UNOFFICIAL VERSION

UPDATED TO 31ST DECEMBER 2016

(c) where the coefficient of fineness (c) exceed .68, the freeboard shall be multiplied by the factor  $\frac{c + .68}{1.36}$

(d) where D exceed  $\frac{(L)}{15}$  the freeboard shall be increased by

$(D - \frac{(L)}{15}) R$ , where

R is  $\frac{(L)}{130}$  at lengths less than 390 feet, and 3 at 390 feet length

and above;

(e) in a ship with an enclosed superstructure covering at least 0.6 L amidships, or with a complete trunk, or with a combination of intact partial superstructures and trunk which extends all fore and aft, where D is less than  $\frac{(L)}{15}$  the freeboard shall be reduced

at the rate laid down in item (e);

(f) where the height of superstructures or trunk is less than the standard height, as determined in accordance with paragraph 33, the reduction shall be modified in the ratio which the actual height bears to the standard height;

(g) where the actual depth to the surface of the freeboard deck amidships is greater or less than D, the difference between these two depths (in inches) shall be added to or deducted from the freeboard as the case may be.

#### PART IV

### COMPUTATION OF FREEBOARDS FOR SAILING SHIPS

63. Subject to paragraph 24 and paragraphs 64 to 70, freeboards for sailing ships shall be computed from the Freeboard Table for Sailing Ships in paragraph 69 in the same manner as the freeboards for steamers are computed from the Freeboard Table for Steamers in paragraph 62.

Computation of freeboard.

64. (1) In sailing ships having a greater rate of rise of floor than 1½ inches per foot, the vertical distance from the top of keel referred to in paragraph 28 shall be reduced by half the difference between the total rise of floor at the half-breadth of the ship and the total rise at 1½ inches per foot; 2 ½ inches per foot of half-breadth is the maximum rate of rise for which a deduction may be made.

Depth for freeboard D.

**LAWS OF TRINIDAD AND TOBAGO**

MINISTRY OF THE ATTORNEY GENERAL AND LEGAL AFFAIRS

www.legalaffairs.gov.tt

604

**Chap. 50:10**

*Shipping*

**[Subsidiary]**

*Shipping (Load Line) Regulations*

(2) Where the form at the lower part of the midship section is of a hollow character or thick garboards are fitted, the depth shall be measured from the point where the line of the flat of the bottom continued inwards cuts the side of the keel.

(3) The depth used with the Freeboard Table shall be taken as not less than  $\frac{L}{12}$ .

Coefficient of fineness.

65. The coefficient of fineness (c) used with the Freeboard Table in paragraph 69 shall be taken as not less than 0.62 and not greater than 0.72.

Superstructures in wood ships.

66. In wood ships the Assigning Authority shall satisfy themselves as to the efficiency of the construction and closing arrangements of superstructures for which deductions are made from the freeboard.

Deductions for superstructures.

67. Where the effective length of superstructures is 1.0 L, the deduction from the freeboard shall be 3 inches at 80 feet length of ship, and 28 inches at 330 feet length and above; deductions at intermediate lengths shall be obtained by interpolation and where the total effective length of superstructures is less than 1.0 L, the deduction shall be a percentage obtained from the following Table:

Type of Super-structures	Total Effective Length of Superstructures											Line
	0	.1L	.2L	.3L	.4L	.5L	.6L	.7L	.8L	.9L	1.0 L	
	Per cent	Per cent	Per cent	Per cent	Per cent	Per cent	Per cent	Per cent	Per cent	Per cent	Per cent	
All types without Bridge	0	7	13	17	23.5	30	47.5	70	80	90	100	A
All types with Bridge*	0	7	14.7	22	3.2	42	56	70	80	90	100	B

\*where the effective length of Bridge is less than 0.2 L, the percentages are obtained by interpolation between lines B and A; percentages for intermediate lengths of superstructures are obtained by interpolation.

Minimum freeboards.

68. Minimum freeboards shall be as follows:

- (a) no addition to the freeboard shall be required for winter freeboard, nor shall a deduction be permitted for Tropical freeboard;

UNOFFICIAL VERSION

UPDATED TO 31ST DECEMBER 2016

- (b) an increase in freeboard of 3 inches shall be made for the Winter North Atlantic freeboard;
- (c) in computing the Fresh Water freeboard for a wood ship, the draught shall be measured from the lower edge of the rabbet of the keel to the centre of the load line disc.

69. Minimum Summer, Winter and Tropical Freeboards for Iron and Steel Flush Deck Sailing Ships, which comply with the Standards laid down in this Schedule are as follows: Freeboard table for sailing ships.

L Feet	Freeboard Inches	L Feet	Freeboard Inches	L Feet	Freeboard Inches	L Feet	Freeboard Inches
80	9.2	140	21.3	200	35.4	270	53.5
90	11.0	150	23.5	210	37.9	280	56.3
100	12.9	160	25.8	220	40.4	290	59.1
110	14.9	170	28.2	230	42.9	300	61.9
120	17.0	180	30.6	240	45.5	310	64.7
130	19.1	190	33.0	250	48.1	320	67.6
				260	50.8	330	70.5

- (a) the freeboards at intermediate lengths shall be obtained by interpolation;
- (b) where c exceeds 0.62, the freeboards shall be multiplied by the factor ;  $\frac{c + 0.62}{1.24}$
- (c) where D exceeds  $\frac{(L)}{12}$  the freeboard shall be increased by  $(D - \frac{(L)}{12}) \times (1 + \frac{(L)}{250})$  inches;
- (d) where the actual depth to the surface of the freeboard deck amidships is greater or less than D, the difference between these two depths (in inches) shall be added to or deducted from the freeboard, as the case may be.

70. The freeboard for a wood sailing ship shall be the minimum freeboard which would be assigned to the ship if she were of iron or steel, with the addition of such amount of freeboard as the Assigning Authority may determine, having regard to the classification, construction, age and condition of the ship. Freeboard for wood sailing ships.

**LAWS OF TRINIDAD AND TOBAGO**

MINISTRY OF THE ATTORNEY GENERAL AND LEGAL AFFAIRS

www.legalaffairs.gov.tt

606

**Chap. 50:10**

*Shipping*

[Subsidiary]

*Shipping (Load Line) Regulations*

**PART V**

**FREEBOARDS FOR STEAMERS CARRYING TIMBER  
DECK CARGOES**

*A—General*

Assignment of timber freeboards. 71. Timber freeboards shall be assigned to a steamer if the steamer, being otherwise entitled to have freeboards assigned to her, complies with this Part to the extent thereby required in her case.

*B—Supplementary Conditions of Assignment*

Construction. 72. The structure of the steamer shall be of sufficient strength for the deeper draught allowed and for the weight of the deck cargo.

Superstructures. 73. The steamer shall have a forecastle of at least standard height and at least 7 per cent of the length of the ship, and, in addition, a poop, or a raised quarterdeck with a strong steel hood or deck house fitted aft.

Machinery casings. 74. Machinery casings on the freeboard deck shall be protected by a superstructure of at least standard height, unless the machinery casings are of sufficient strength and height to permit of the carriage of timber alongside.

Double bottom tanks. 75. Double bottom tanks where fitted within the midship half length of the steamer shall have adequate longitudinal subdivision.

Bulwarks. 76. The steamer shall be fitted either with permanent bulwarks at least 3 feet 3 inches high, specially stiffened on the upper edge and supported by strong bulwark stays attached to the deck in the way of the beams and provided with necessary freeing ports, or with efficient rails at least 3 feet 3 inches high and of specially strong construction.

Steering arrangements. 77. Steering arrangements shall be effectively protected from damage by cargo, and, as far as practicable, shall be accessible; efficient provision shall be made for steering in the event of a breakdown in the main steering arrangements.

Lashings. 78. Eye plates for lashing shall be rivetted to the sheerstrake at intervals of not more than 10 feet, the distance from an end bulkhead of a superstructure to the first eye plate being not more than 6 feet 6 inches; additional eye plates may be fitted the stringer plate.

UNOFFICIAL VERSION

UPDATED TO 31ST DECEMBER 2016

79. (1) Where the Assigning Authority is satisfied that the steamer is suitable and that the conditions and arrangements are at least equal to the foregoing requirements for the carriage of timber deck cargo, the summer freeboards computed in accordance with this Schedule and the Tables in Part III may be modified to give special timber freeboards, by substituting the following percentages for those in paragraph 48:

Computation of  
freeboard

Total Effective length of superstructures. (E).

	0	.1L	.2L	.3L	.4L	.5L	.6L	.7L	.8L	.9L	1.0 L
	Per	Per	Per	Per	Per	Per	Per	Per	Per	Per	Per
	cent	cent	cent	cent	cent	cent	cent	cent	cent	cent	cent
All types ...	20	30.73	41.3	52.25	63	69.25	75.5	81.5	87.5	93.75	100

(2) The following freeboards shall be computed as follows:

- (a) the Winter Timber freeboard shall be obtained by adding to the Summer Timber freeboard one-third of an inch per foot of the moulded Summer Timber draught;
- (b) the Winter North Atlantic Timber freeboard shall be identical with the Winter North Atlantic freeboard prescribed in paragraph 60;
- (c) the Tropical Timber freeboard shall be obtained by deducting from the Summer Timber freeboard one-quarter of an inch per foot of the moulded Summer Timber draught.

**PART VI**

**FREEBOARDS FOR TANKERS**

*A—General*

80. Tanker freeboards shall be assigned to a ship, being a tanker, if the ship complies with the Conditions of Assignment and also complies with this Part to the extent thereby required in her case.

Assignment of  
tanker  
freeboards.

**LAWS OF TRINIDAD AND TOBAGO**

MINISTRY OF THE ATTORNEY GENERAL AND LEGAL AFFAIRS

www.legalaffairs.gov.tt

608

**Chap. 50:10**

*Shipping*

[Subsidiary]

*Shipping (Load Line) Regulations*

*B—Supplementary Conditions of Assignment*

- Construction of ship. 81. The structure of the ship shall be of sufficient strength for the increase draught corresponding to the freeboard assigned.
- Forecastle. 82. The ship shall have a forecastle of which the length is not less than 7 per cent of the length of the ship and the height is not less than the standard height.
- Machinery castings. 83. (1) The openings in machinery casings on the freeboard deck shall be fitted with steel doors.
- (2) The casings shall be protected by an enclosed poop or bridge of at least standard height, or by a deckhouse of equal height and of equivalent strength.
- (3) The bulkheads at the ends of these structures shall be of the scantlings required for bridge front bulkheads.
- (4) All entrances to the structures from the freeboard deck shall be fitted with effective closing appliances and the sills shall be at least 18 inches above the deck.
- (5) Exposed machinery casings on the superstructure deck are to be of substantial construction, and all openings in them shall be fitted with steel closing appliances permanently attached to the casings and capable of being closed and secured from both sides; the sills of such openings shall be at least 15 inches above the deck.
- (6) Fiddley openings shall be as high above the superstructure deck as is reasonable and practicable and shall have strong steel covers permanently attached in their proper positions.
- Gangway. 84. An efficiently constructed permanent gangway of sufficient strength for its exposed position shall be fitted fore and aft of the level of the superstructure deck between the poop and midship bridge, and when any of the crew are berthed forward, from the bridge to the forecastle, unless other equivalent means of access are provided to carry out the purpose of the gangway, such as passages below deck.
- Protection of crew, access to machinery space, etc. 85. (1) Safe and satisfactory access from the gangway level to the quarters of the crew, the machinery space and all other parts used in the necessary work of the ship, shall be available at all times.
- (2) Subparagraph (1) does not apply to pump rooms if suitable means of access are provided from the freeboard deck, and the access openings are fitted with Class 1 closing appliances.

UNOFFICIAL VERSION

UPDATED TO 31ST DECEMBER 2016

86. All hatchways on the freeboard deck and on the deck of expansion trunks shall be closed watertight by efficient steel covers. Hatchways.

87. Ventilators to spaces below the freeboard deck shall be of ample strength or shall be protected by superstructures or by equally efficient means. Ventilators.

88. (1) Ships with bulwarks shall have open rails fitted for at least half the length of the exposed portion of the weather deck or such other freeing arrangements as are in the opinion of the Assigning Authority effective for the purpose of freeing the decks of water. Freeing arrangements.

(2) The upper edge of the sheer strake shall be kept as low as practicable, and as a general rule shall not be higher than the upper edge of the gunwale bar.

(3) Where superstructures are connected by trunks, open rails shall be fitted for the whole length of the weather portions of the freeboard deck.

*C—Computation of Freeboard*

89. (1) Where the Assigning Authority is satisfied that the foregoing requirements are fulfilled, it shall compute the freeboards in accordance with Part III of this Schedule, subject to paragraphs 90 and 91 and to the substitution of the Table set out in paragraph 93 for the Table set out in paragraph 62. Computation of freeboard.

(2) No addition shall be made under paragraph 62(a) in respect of a flush deck steamer.

90. When the total effective length of superstructures is less than 1.0 L the deduction shall be the percentage of the deduction for a superstructure of length 1.0 L, obtained from the following Table: Deduction for detached superstructures.

Total Effective Length of superstructures											
	0	.1L	.2L	.3L	.4L	.5L	.6L	.7L	.8L	.9L	1.0 L
	Per cent	Per cent	Per cent	Per cent	Per cent	Per cent	Per cent	Per cent	Per cent	Per cent	Per cent
All types ...	0	7	14	21	31	41	52	63	75.3	87.7	100

**LAWS OF TRINIDAD AND TOBAGO**

MINISTRY OF THE ATTORNEY GENERAL AND LEGAL AFFAIRS

www.legalaffairs.gov.tt

610

**Chap. 50:10**

*Shipping*

**[Subsidiary]**

*Shipping (Load Line) Regulations*

Deduction for excess sheer.

91. (1) Where the sheer is greater than the standard, the correction for excess sheer as determined under paragraph 52 shall be deducted from the freeboard for all tankers.

(2) Paragraph 54 shall not apply except that the maximum deduction for excess sheer shall be 1½ inches at 100 feet length of ship and shall increase at the rate of 1½ inches for each additional 100 feet in the length of the ship.

Winter North Atlantic freeboard.

92. The maximum Winter North Atlantic freeboard shall be the Winter freeboard plus an addition at the rate of 1 inch per 100 feet in length.

Freeboard Table for tankers.

93. (1) The freeboard Table for Tankers shall be as follows:

L Feet	Freeboard Inches	L Feet	Freeboard Inches
190	21.5	400	62.5
200	23.1	410	64.9
210	24.7	420	67.4
220	26.3	430	69.9
230	28.0	440	72.5
240	29.7	450	75.1
250	31.5	460	77.7
260	33.3	470	80.2
270	35.2	480	82.7
280	37.1	490	85.1
290	39.1	500	87.5
300	41.1	510	89.8
310	43.1	520	92.1
320	45.1	530	94.3
330	47.1	540	96.5
340	49.2	550	98.6
350	51.3	560	100.7
360	53.5	570	102.7
370	55.7	580	104.6
380	57.9	590	106.5
390	60.2	600	108.4

(2) The freeboards for ships above 600 feet shall be determined by the Minister.

UNOFFICIAL VERSION

UPDATED TO 31ST DECEMBER 2016

**PART VII**

**FREEBOARDS FOR SHIPS OF SPECIAL TYPE**

94. (1) In the case of steamers of special type over 300 feet in length possessing constructional features similar to those of a tanker which, in the opinion of the Minister, afford extra invulnerability the sea, a reduction in the freeboard computed for steamers under Part III may be granted.

Provisions for steamers of special type against.

(2) The amount of such reduction shall be determined by the Minister with reference to the freeboard assigned to tankers, having regard to the extent to which the steamer complies with the Conditions of Assignment and with the requirements of Part VI of this Schedule and the degree of subdivision provided in the ship, but the freeboard assigned to such ship shall in no case be less than the freeboard which would be assigned to her if she were a tanker.

**NINTH SCHEDULE**

**FORM OF DRAFT AND FREEBOARD NOTICE  
TO BE POSTED UP**

**NOTICE**

Pursuant of section 303(2) of the Shipping Act, Chap. 50:10

SHIP .....  
PORT OF REGISTRY .....  
GROSS TONNAGE\* .....

- (1) Summer freeboard .....millimetres  
corresponding to a mean draught † of .....millimetres  
(equal to ..... feet ..... inches).
- (2) Winter freeboard .....millimetres  
corresponding to a mean draught † of .....millimetres  
(equal to ..... feet ..... inches).

LAWS OF TRINIDAD AND TOBAGO

NINTH SCHEDULE—(Continued)

- (3) Tropical freeboard .....millimetres  
corresponding to a mean draught† of .....millimetres  
(equal to ..... feet ..... inches).
- (4) Winter North Atlantic freeboard .....millimetres  
corresponding to a mean draught† of .....millimetres  
(equal to ..... feet ..... inches).
- (5) Allowance for fresh water for all freeboards other than timber  
freeboards .....millimetres.
- (6) Timber summer freeboard .....millimetres  
corresponding to a mean draught† of .....millimetres  
(equal to ..... feet ..... inches).
- (7) Timber winter freeboard .....millimetres  
corresponding to a mean draught† of .....millimetres  
(equal to ..... feet ..... inches).
- (8) Timber tropical freeboard .....millimetres  
corresponding to a mean draught† of .....millimetres  
(equal to ..... feet ..... inches).
- (9) Timber Winter North Atlantic freeboard .....millimetres  
corresponding to a mean draught† of .....millimetres  
(equal to ..... feet ..... inches).
- (10) Allowance for fresh water for timber freeboards .....  
..... millimetres.

The particulars to be given above of freeboards and allowances for fresh water are to be taken from the load line certificate currently in force in respect of the ship. Paragraphs referring to freeboards which the certificate shows have not been assigned to the ship must be deleted.

\*In the case of a ship having alternative gross tonnages, both must be given.

- †1. The mean draught to be given above is the mean of the draughts which would be shown on the scales of measurements on the stem and on the stern post of the ship if it were so loaded that the upper edge of the load line on each side of the ship appropriate to the particular freeboard were on the surface of the water.
2. Where the draught is shown on the scales of measurement on the stem and on the stern post of the ship in feet the mean draught must be given in both millimetres and feet and inches using an equivalent of 25.4 millimetres to one inch.

---

**LAWS OF TRINIDAD AND TOBAGO**

MINISTRY OF THE ATTORNEY GENERAL AND LEGAL AFFAIRS

www.legalaffairs.gov.tt

614

**Chap. 50:10**

*Shipping*

**[Subsidiary]**

*Shipping (Load Line) Regulations*

**PARTICULARS OF LOADING**

1	2	3	4	5	6	7	8	9
Date	Place	Actual Draught			Mean Freeboard		Signature of Master and an Officer	
		Forward	Aft	Mean	Actual ( <i>see</i> notes 1 and 2 below)	Corrected ( <i>see</i> note 3 below)	Master	An Officer

**NOTES:**

1. The actual mean freeboard (Column 6) is the mean of the freeboards on each side of the ship at the time when the ship is loaded and ready to leave.

2. If the actual mean freeboard is less than the appropriate minimum salt water freeboard as shown on the load line certificate there must be entered in Column 7 the corrected freeboard arrived at after making any allowances for density of water, rubbish to be discharged overboard and fuel, water and stores to be consumed on any stretch of river or inland water, being allowances duly entered in the ship's official log-book.

3. If the actual mean freeboard is greater than the appropriate salt water freeboard, Column 7 need not be filled in.

UNOFFICIAL VERSION

UPDATED TO 31ST DECEMBER 2016

**TENTH SCHEDULE**

Regulation 13.

**STABILITY DECLARATION**

(COMPLIANCE WITH THE SHIPPING (LOAD LINE) REGULATIONS, 1992)

Ship's Name	Date Keel Laid	Type					File No.
Official No.	Type of Freeboard Assigned*						
	A	B	B-100	B-60	B.Timber	Less than Min. F'bd.	
Mld. Dimensions Summer Draught, Freeboard	Owner		Builder		Assigning Authority		
	Method of Calculation			Examined by	Date		
	Direct	Computer Prog.†					
Hydrostatic Data							
Capacities and centres of Gravity for all Spaces							
Cross Curves							
Inclining Test	Condition of Ship for Test			Place Date	Surveyor in Attendance		
	TEST REPORT AND RESULT			Examined by	Date		
	If test was dispensed with, state why						
STABILITY INFORMATION	Is Schedule 7 complied with						
	Is Schedule 4, Part 1 para. 2(2) complied with						
	Are Schedules 4, 1(d) and 5 Part 1, para 5(b) complied with						
	Examined by				Date		

\*Delete that which is not applicable.

†State name and code number of Programme.

General Comments:

*(continued overleaf)*

To be Completed at Headquarters

The Stability, and Stability Information was approved and stamped on ..... the Assigning Authority was informed on .....

Signed ..... Date .....

**LAWS OF TRINIDAD AND TOBAGO**

MINISTRY OF THE ATTORNEY GENERAL AND LEGAL AFFAIRS

www.legalaffairs.gov.tt

616

**Chap. 50:10**

*Shipping*

[Subsidiary]

*Shipping (Load Line) Regulations*

INFORMATION FOR STABILITY RECORDS

Name				Owner						File No.			
Builder				Type			Class			Passengers		Crew	
Dimensions				Tonnage		Gross Net				Deadweight			
Condition	Displacement	Draught	Trim	KG	KB	F.S.	GM corr	L.C.B.	L.C.F.	CB	T.P.C.	M.T.I.C.	
Lightship													
Load													
Ballast													
Angle of Heel due to flooding							Alterations Affecting Stability						
Angle of Heel due to Passenger/Cargo Movement							Type				Date		
Angle of Heel due to Turning													
Angle of Heel due to Wind Pressure													
Projected Area													
Projected Area V.C.G.													
Sheer		Length of Superstructures, etc. *Indicates Erection Allowed in Stability Curves						Permanent Ballast					
Aft	Forward	Poop	Bridge	Forecastle	Trunk								

Deck Cargo		
L x B x H	Tons (Incl. % Absorbtion)	Density

Completed by .....

UNOFFICIAL VERSION

UPDATED TO 31ST DECEMBER 2016



REPUBLIC OF TRINIDAD AND TOBAGO  
DRAUGHT OF WATER AND FREEBOARD

Form FRE 15

NOTICE

(Pursuant to section 303(2) of the Shipping Act)

SHIP ..... PORT OF REGISTRY .....

OFFICIAL NUMBER ..... GROSS TONNAGE .....  
(Where a ship has alternative gross tonnages, both must be given)

- (1) Summer freeboard\* ..... millimetres corresponding to a mean draught† of ..... millimetres (equal to ..... feet ..... inches).
- (2) Winter freeboard\* ..... millimetres corresponding to a mean draught† of ..... millimetres (equal to ..... feet ..... inches).
- (3) Tropical freeboard\* ..... millimetres corresponding to a mean draught† of ..... millimetres (equal to ..... feet ..... inches).
- (4) Winter North Atlantic freeboard\* ..... millimetres corresponding to a mean draught† of ..... millimetres (equal to ..... feet ..... inches).
- (5) Allowance for fresh water for all freeboards other than timber freeboards\* ..... millimetres.
- (6) Timber Summer freeboard\* ..... millimetres corresponding to a mean draught† of ..... millimetres (equal to ..... feet ..... inches).
- (7) Timber Winter freeboard\* ..... millimetres corresponding to a mean draught† of ..... millimetres (equal to ..... feet ..... inches).
- (8) Timber Tropical freeboard\* ..... millimetres corresponding to a mean draught† of ..... millimetres (equal to ..... feet ..... inches).
- (9) Timber Winter North Atlantic freeboard\* ..... millimetres corresponding to a mean draught† of ..... millimetres (equal to ..... feet ..... inches).
- (10) Allowance for fresh water for timber freeboard\* ..... millimetres.

\*Particulars to be given above of freeboards and allowance for fresh water are to be taken from the load line certificate currently in force in respect of the ship. Paragraphs referring to freeboards which the certificate shows have not been assigned to the ship must be deleted.

†The mean draught to be given above is the mean of the draughts which would be shown on the scales of measurement on the stem and on the stern post of the ship if it were so loaded that the upper edge of the load line on each side of the ship appropriate the particular freeboard were on the surface of the water. Where the draught is shown on the scales of measurement on the stem and on the stern post of the ship in feet the mean draught must be given both in millimetres and feet and inches using an equivalent of 25.4 millimetres to one inch.

LAWS OF TRINIDAD AND TOBAGO

MINISTRY OF THE ATTORNEY GENERAL AND LEGAL AFFAIRS

www.legalaffairs.gov.tt

618

Chap. 50:10

Shipping

[Subsidiary]

Shipping (Load Line) Regulations

PARTICULARS OF LOADING								
1	2	3	4	5	6	7	8	9
Date	Place	Actual Draught			Mean Freeboard		Signature of Master and an Officer	
		Forward	Aft	Mean	Actual ( <i>see</i> notes 1 and 2 below)	Corrected ( <i>see</i> note 3 below)	Master	An Officer

NOTES:

1. The actual mean freeboard (Column 6) is the mean of the freeboards on each side of the ship at the time when the ship is loaded and ready to leave.
  2. If the actual mean freeboard is less than the appropriate minimum salt water freeboard as shown on the load line certificate there must be entered in Column 7 the corrected freeboard arrived at after making any allowances for density of water, rubbish to be discharged overboard and fuel, water and stores to be consumed on any stretch of river or inland water, being allowances duly entered in the ship's Official Log Book.
  3. If the actual mean freeboard is greater than the appropriate salt water freeboard, Column 7 need not be filled in. This note should be posted in some conspicuous place on board the ship, where it can be seen by all members of the crew, before the ship leaves any dock, wharf, harbour or other place for the purpose of proceeding to sea and is to be kept so posted until after the ship arrives at any other dock, wharf, harbour or place.
- The date and time of recording the above particulars on each occasion must be entered in the Official Log Book. This form should not be handed in with the Official Log Book and Agreement at the termination of the Agreement. It can be used until completed, when a further copy should be obtained.

UNOFFICIAL VERSION

UPDATED TO 31ST DECEMBER 2016

**SHIPPING (LOAD LINES) (EXEMPTION) ORDER**

23/1993.

*made under section 286(2)*

**1.** This Order may be cited as the Shipping (Load Lines) (Exemption) Order. Citation.

**2.** In this Order— Interpretation.

“Act” means the Shipping Act;

“pilot boat” means a boat regularly employed by the Pilots Association of Trinidad and Tobago for the purposes of conveying pilots to and from ships during pilotage operations;

“sailing ship” means a ship designed to carry sail, whether as the sole means of propulsion or as a supplementary means.

**3.** (1) Ships under 24 metres in length engaged solely in the coasting trade, being ships of the following classes, shall be exempt from the provisions of Part XII of the Act while not carrying cargo— Ships to be exempted.

- (a) tugs and salvage ships;
- (b) ships engaged in the surveying of ports and harbours or the approach thereto;
- (c) hopper barges and dredgers;
- (d) pilot boats;
- (e) Trinidad and Tobago Government ships operated for non-commercial purposes;
- (f) sailing ships;
- (g) ships in respect of which passenger ship certificates are in force specifying limits beyond which the ship must not ply, and which operate solely within those limits;
- (h) ships carrying not more than twelve passengers on voyages during the course of which they are at no time more than fifteen miles from the point of departure or more than three miles from land.

**LAWS OF TRINIDAD AND TOBAGO**

MINISTRY OF THE ATTORNEY GENERAL AND LEGAL AFFAIRS

[www.legalaffairs.gov.tt](http://www.legalaffairs.gov.tt)

620

**Chap. 50:10**

*Shipping*

**[Subsidiary]**

*Shipping (Load Lines) (Exemption) Order*

---

(2) Ships under subsection (1)(g) shall also be exempt from the Provision of Part XII of the Act while carrying cargo in accordance with the terms, if any, of the ship's passenger ship certificate expressly authorising the carriage of cargo.

---

UNOFFICIAL VERSION

UPDATED TO 31ST DECEMBER 2016

**SHIPPING (LOAD LINES) (DECK CARGO)  
REGULATIONS**

ARRANGEMENT OF REGULATIONS

**REGULATION**

1. Citation.

**PART I  
GENERAL**

2. Interpretation.

**PART II  
GENERAL REQUIREMENTS APPLIANCE**

3. Application.
4. Sitting, distribution and stowage of deck cargo.
5. Securing of deck cargo.
6. Access.

**PART III  
ADDITIONAL REQUIREMENTS APPLICABLE TO  
TIMBER DECK CARGO**

7. Application.
8. Circumstances in which regulations 8 to 12 apply.
9. Maximum height of timber deck cargo.
10. Access.
11. Stowing and securing of timber deck cargo.
12. Uprights.
13. Circumstances in which regulations 13 to 15 apply.
14. Stowage of timber deck cargo in relation to superstructures.
15. Securing of timber deck cargo.

**SCHEDULE.**

[Subsidiary]

24/1993.

**SHIPPING (LOAD LINES) (DECK CARGO)  
REGULATIONS**

*made under section 294*

Citation. **1.** These Regulations may be cited as the Shipping (Load Lines) (Deck Cargo) Regulations.

**PART I**

**GENERAL**

Interpretation. **2.** In these Regulations—

“deck cargo” means cargo carried in any uncovered space on the deck of a ship;

“load line”, “Timber load line”, “superstructure”, “standard height” in relation to a superstructure, “watertight” and “weathertight” have the meanings respectively assigned to them by the Shipping (Load Line) Regulations;

Sub. Leg.

“timber deck cargo” means deck cargo consisting of timber;

“weather deck” means the uppermost complete deck exposed to weather and sea, a deck which is stepped being taken to consist for this purpose of the lowest line of the deck and the continuation of that line parallel to the upperpart of the deck.

**PART II**

**GENERAL REQUIREMENTS APPLICABLE TO ALL  
DECK CARGO**

Application. **3.** The requirements set out in this Part shall, except as otherwise provided in Part III, apply in respect of all deck cargo.

Sitting,  
distribution and  
stowage of deck  
cargo.

**4.** Deck cargo shall be so distributed and stowed—

(a) as to avoid excessive loading having regard to the strength of the deck and integral supporting structure of the ship;

- (b) as to ensure that the ship will retain adequate stability at all stages of the voyage having regard in particular to—
  - (i) the vertical distribution of the deck cargo;
  - (ii) wind moments which may normally be expected on the voyage;
  - (iii) losses of weight in the ship, including in particular those due to the consumption of fuel and stores; and
  - (iv) possible increases of weight of the ship or deck cargo, including in particular those due to the absorption of water and to icing;
- (c) as not to impair the weathertight or watertight integrity of any part of the ship or its fittings or appliances, and as to ensure the proper protection of ventilators and air pipes;
- (d) as to ensure that its height above the deck or any other part of the ship on which it stands will not interfere with the navigation or working of the ship;
- (e) as to ensure that it will not interfere with or obstruct access to the ship's steering arrangements, including emergency steering arrangements;
- (f) as to ensure that it will not interfere with or obstruct safe and efficient access by the crew to or between their quarters and any machinery space or other part of the ship used in the working of the ship, and will not in particular obstruct any opening giving access to those positions or impede its being readily secured weathertight.

**5.** Deck cargo shall be so secured as to ensure, as far as practicable, that there will be no movement of that cargo relative

Securing of deck cargo.

**LAWS OF TRINIDAD AND TOBAGO**

MINISTRY OF THE ATTORNEY GENERAL AND LEGAL AFFAIRS

www.legalaffairs.gov.tt

624

**Chap. 50:10**

*Shipping*

[Subsidiary]

*Shipping (Load Lines) (Deck Cargo) Regulations*

to the ship in the worst sea and weather conditions which may normally be expected on the voyage, and lashings and all fittings used for their attachment shall be of adequate strength for that purpose.

Access.

**6.** (1) Except where access for the crew between their quarters and the machinery spaces and other parts of the ship used in the working of the ship is provided by means of a passage suitable for the purpose situated on or under the deck carrying the deck cargo, such access shall be provided by means of a walkway which complies with the requirements of subregulation (2).

(2) The walkway shall be not less than one metre in width, and shall be fitted over the deck cargo and effectively secured so as to provide safe and efficient access for the crew between the positions mentioned in subregulation (1) and shall be fitted on each side with a set of efficient guard rails or guard wires not less than one metre in height and consisting of not less than three courses of rails or wires supported by stanchions securely fitted to the walkway at intervals not exceeding 1.5 metres and no opening in the guard rails or guard wires below the lowest course shall exceed two hundred and thirty millimetres in height and no opening above that course shall exceed three hundred and eighty millimetres in height.

**PART III**

**ADDITIONAL REQUIREMENTS APPLICABLE TO  
TIMBER DECK CARGO**

Application.

**7.** The requirements set out in regulations 8 to 15 shall apply in respect of timber deck cargo in the circumstances specified in the Regulations; and the requirements set out in Part II shall also apply in respect of such cargo except insofar as compliance therewith would be inconsistent with compliance with the requirements of regulations 8 to 15.

UNOFFICIAL VERSION

UPDATED TO 31ST DECEMBER 2016

**8.** The requirements of regulations 8 to 12 apply in respect of timber deck cargo carried by a ship which—

Circumstances in which regulations 8 to 12 apply.

- (a) is not marked with timber load lines; or
- (b) is so marked, but is loaded to a depth less than that indicated by the load line which, if timber load lines were not marked, would be appropriate in the circumstances.

**9.** Timber deck cargo carried by a ship within any area specified in column 1 of the Schedule as a Winter Seasonal Area in relation to that ship, during the period specified in relation to that area in column 2 of the Schedule as the Winter period for the ship, shall be so stowed that at no point throughout its length does that height of the timber deck cargo above the level of the weather deck at side exceed one-third of the extreme breadth of the ship.

Maximum height of timber deck cargo.

**10.** Where timber deck cargo occupies the whole or substantially the whole of the uncovered space on the deck of a ship, means of access for the crew between their quarters and the machinery spaces and other parts of the ship used in the working of the ship shall be provided in the form of a walkway fitted over the timber deck cargo and complying with the requirements applicable to a walkway under regulation 6(2) and such walkway shall be provided notwithstanding that a passage on or under the deck as described in regulation 6(1) is also provided.

Access.

**11.** Timber deck cargo shall be compactly stowed and secured throughout its length by a system of overall lashings of adequate strength so as to ensure, as far as practicable, that there will be no movement of that cargo relative to the ship in the worst sea and weather conditions which may normally be expected on the voyage. Efficient arrangements for the release of lashings and fittings shall be provided and be so situated as to be readily accessible at all times.

Stowing and securing of timber deck cargo.

LAWS OF TRINIDAD AND TOBAGO

MINISTRY OF THE ATTORNEY GENERAL AND LEGAL AFFAIRS

www.legalaffairs.gov.tt

626

Chap. 50:10

Shipping

[Subsidiary]

Shipping (Load Lines) (Deck Cargo) Regulations

Uprights.

**12.** Where the nature of the timber is such that uprights are necessary in order to comply with regulation 11, uprights shall be fitted which are of sufficient strength for the purpose. They shall be secured in position by angles or metal sockets of sufficient strength for the purpose or by equivalent means and shall be so spaced as to provide efficient support taking into account the nature and length of the timber, so however that the space between any two uprights fore and aft shall not exceed three metres.

Circumstances in which regulations 13 to 15 apply.

**13.** The requirements of regulations 13 to 15 apply in respect of timber deck cargo carried by a ship which is marked with timber load lines and is loaded to a depth greater than that indicated by the load line which, if timber load lines were not marked, would be appropriate in the circumstances; and the requirements of regulations 8 to 12 shall also apply in such a case except insofar as compliance therewith would be inconsistent with compliance with the requirements of regulations 13 to 15.

Stowage of timber deck cargo in relation to super structures.

**14.** (1) Timber deck cargo stowed in any well between superstructures shall be stowed as solidly as possible so as to extend over the entire available length of the well to a height not less than the standard height of a superstructure other than a raised quarterdeck.

(2) Timber deck cargo stowed in a position having a limiting superstructure at the forward end but no such superstructure at the after end shall be stowed so as to extend over the entire available length between the superstructure and the after end of the aftermost hatchway, to the height and in the manner specified in subregulation (1).

Securing of timber deck cargo.

**15.** (1) Timber deck cargo shall be efficiently secured throughout its length by independent overall lashings spaced not more than three metres apart save as otherwise provided in subregulation (3).

UNOFFICIAL VERSION

UPDATED TO 31ST DECEMBER 2016

(2) Eye plates for the lashings referred to in subregulation (1), shall be efficiently attached to the sheer strake or to the deck stringer plate at intervals of not more than three metres.

(3) The distance from an end bulkhead of a superstructure to the first eye plate shall be not more than two metres.

(4) Where there is no bulkhead, eye plates and lashings shall be provided at distances of 0.6 metres and 1.5 metres from the ends of the timber deck cargo.

(5) Lashings shall be of not less than nineteen millimetres close link chain or of flexible wire rope of equivalent strength, fitted with sliphooks and turnbuckles so positioned as to be accessible at all times.

(6) Wire rope lashings shall have a length of long link chain sufficient to permit the length of lashings to be regulated.

(7) When timber is in lengths less than 3.6 metres the spacing of the lashings shall be reduced or suitable provision made to suit the length of timber.

LAWS OF TRINIDAD AND TOBAGO

MINISTRY OF THE ATTORNEY GENERAL AND LEGAL AFFAIRS

www.legalaffairs.gov.tt

628

Chap. 50:10

Shipping

[Subsidiary]

Shipping (Load Lines) (Deck Cargo) Regulations

(Regulation 9)

SCHEDULE

COLUMN 1

COLUMN 2

WINTER SEASONAL ZONES OR AREAS  
FOR ALL SHIPS

WINTER PERIOD

*North Atlantic Winter Seasonal Zone I*

16th October to 15th April

1. The area lying within the meridian of longitude 50° 00' West from the coast of Greenland to latitude 45° 00' North, thence the parallel of latitude 45° 00' North to longitude 15° 00' West, thence the meridian of longitude 15° 00' West to latitude 60° 00' North, thence the parallel of latitude 60° 00' North to the Greenwich Meridian, thence this meridian northwards.

*North Atlantic Winter Seasonal Zone II*

1st November to 31st March

2. The area lying within the meridian of longitude 68° 30' West from the coast of the United States to latitude 40° 00' North, thence the rhumb line to the point latitude 36° 00' North longitude 73° 00' West, thence the parallel of latitude 36° 00' North to longitude 25° 00' West, and thence the rhumb line to Cape Torinana.

Excluded from this Zone area the areas numbered 1 and 3 and the Baltic Sea bounded by the parallel of latitude of the Skaw in the Skagerrak.

The Shetland Islands are to be considered as being on the boundary line between the area numbered 1 and this area.

*North Atlantic Winter Seasonal Area*

For ships over 100 metres in length:  
16th December to 15th February. For  
ships of 100 metres or less in length:  
1st November to 31st March

3. The area lying within the meridian of longitude 68° 30' West from the coast of the United States to latitude 40° 00' North, thence the rhumb line to the southernmost intersection of the meridian of longitude 61° 00' West with the coast of Canada and thence the East coasts of Canada and the United States.

*North Pacific Winter Seasonal Zone*

16th October to 15th April

4. The area having as its southern boundary the parallel of latitude 50° 00' North from the East coast of the U.S.S.R. to the West coast of Sakhalin, thence the West coast of Sakhalin to the southern extremity of Cape Kril'on, thence the rhumb line to Wakkanai, Hokkaido, Japan, thence the

UNOFFICIAL VERSION

UPDATED TO 31ST DECEMBER 2016

East and South coasts of Hokkaido to longitude 145° 00' East, thence the meridian of longitude 145° 00' East to latitude 35° 00' North, thence the parallel of latitude 35° 00' North to longitude 150° 00' West and thence the rhumb line to the southern extremity of Dall Island, Alaska.

*Southern Winter Seasonal Zone*

16th April to 15th October

5. The area having as its northern boundary the rhumb line from the East coast of the American continent at Cape Tres Puntas to the point latitude 34° 00' South, longitude 50° 00' West, thence the parallel of latitude 34° 00' South to longitude 17° 00' East, thence the rhumb line to the point latitude 35° 10' South, longitude 20° 00' East, thence the rhumb line to the point latitude 34° 00' South, longitude 28° 00' East, thence the rhumb line to the point latitude 35° 00' South, longitude 118° 00' East, and thence the rhumb line to Cape Grim on the North-West coast of Tasmania, thence along the North and East coasts of Tasmania to the southernmost point of Bruny island, thence the rhumb line to Black Rock Point on Stewart Island, thence the rhumb line to the point latitude 47° 00' South, longitude 170° 00' East, thence the rhumb line to the point latitude 33° 00' South, longitude 170° 00' West and thence the parallel of latitude 33° 00' South, longitude 79° 00' West, thence the rhumb line to the point 41° 00' South, longitude 75° 00' West, thence the rhumb line to Punta Corona lighthouse on Chiloe Island, latitude 41° 47' South, longitude 73° 53' West, thence along the North, East and South coasts of Chiloe Island to the point latitude 43° 20' South, longitude 74° 20' West to the parallel of latitude 45° 45' South, including the inner zone of Chiloe channels from the meridian 74° 20' West to the East.

Valparaiso is to be considered as being on the boundary line of this area.

ADDITIONAL WINTER SEASONAL AREAS FOR SHIPS OF 100 METRES OR LESS IN LENGTH

*Baltic Sea*

1st November to 31st March

6. The Baltic Sea bounded by the parallel of latitude of the Skaw in the Skagerrak.

*Area of Black Sea*

1st December to 28/29th February

7. The area of the Black Sea lying North of latitude 44° 00' North.

LAWS OF TRINIDAD AND TOBAGO

MINISTRY OF THE ATTORNEY GENERAL AND LEGAL AFFAIRS

www.legalaffairs.gov.tt

630

Chap. 50:10

Shipping

[Subsidiary]

Shipping (Load Lines) (Deck Cargo) Regulations

*Area of Mediterranean*

16th December to 15th March

8. The area of the Mediterranean bounded on the North and West by the coasts of France and Spain and the meridian of longitude 3° 00' East from the coast of Spain to latitude 40° 00' North on the South by the parallel of latitude 40° 00' North from longitude 3° 00' East to the West coast of Sardinia; on the East by the West and North coasts of Sardinia from latitude 40° 00' North to longitude 9° 00', thence by the meridian of longitude 9° 00' East to the South coast of Corsica, thence by the West and North coasts of Corsica to longitude 9° 00' East and thence by the rhumb line to Cape Sicie.

*Area of Sea of Japan*

1st December to 28/29th February

9. The area of the sea of Japan lying between the parallel of latitude 50° 00' North and the rhumb line from the East coast of Korea at latitude 38° 00' North to the West coast of Hokkaido, Japan, at latitude 43° 12' North.

*Special Winter Seasonal Area in North Atlantic*

1st November to 31st March

10. The area bounded on the North and West by the East coast of the United States; on the East by the meridian of longitude 68° 30' West from the coast of the United States to latitude 40° 00' North and thence by the rhumb line to the point latitude 36° 00' North, longitude 73° 00' West, on the South by the parallel of latitude 36° 00' North.

*Ports on boundary lines*

For the purposes of the application of the provisions of this Schedule to—

11. (1) a ship at a port which stands on, or is required under the foregoing provisions of this Schedule to be considered as being on, the boundary line between two zones or areas specified therein or between a zone and an area so specified, the port shall be deemed to be within the zone or area into which the ship is about to proceed or from which she has arrived, as the case may be.

(2) a ship at a port which stands on, or is required as aforesaid to be considered as being on, the boundary line of a zone or area not being a port falling within subparagraph (1) the port shall be deemed to be within that zone or area only if the ship is proceeding to or has arrived from that zone or area, as the case may be.

UNOFFICIAL VERSION

UPDATED TO 31ST DECEMBER 2016

**SHIPPING (CERTIFICATION OF SEAMEN)  
(DECK RATINGS) REGULATIONS**

ARRANGEMENT OF REGULATIONS

**REGULATION**

1. Citation and Repeal.
2. Definitions.
3. Classification of deck ratings and classes of certificates.
4. Certificates equivalent.
5. Seaman Class 4.
6. Seaman Class 3.
7. Seaman Class 2.
8. Seaman Class 1 (AB).
9. Examinations and appointments of examiners.
10. Application for examination and issue of Certificate of Competency.
11. Qualifying sea service.
12. Reduction of qualifying sea service.
13. Navigational Watch Rating endorsement.
14. Application for Certificates of Competency or Classification.
15. Record of certificates.
16. Loss of certificates.
17. Fees.

**FIRST SCHEDULE.**

**SECOND SCHEDULE.**

**THIRD SCHEDULE.**

**FOURTH SCHEDULE.**

**FIFTH SCHEDULE.**

**SIXTH SCHEDULE.**

**SEVENTH SCHEDULE.**

**EIGHTH SCHEDULE.**

[Subsidiary]

142/1993.

**SHIPPING (CERTIFICATION OF SEAMEN)  
(DECK RATINGS) REGULATIONS**

*made under section 87*

Citation and  
Repeal.

**1.** (1) These Regulations may be cited as the Shipping (Certification of Seamen) (Deck Ratings) Regulations.

(2) The Merchant Shipping (Certificates of Competency as an A.B.) (Trinidad and Tobago) Regulations, 1960, are hereby repealed.

Definitions.

**2.** In these Regulations—

“major ship” means a ship having in the case of a sailing ship a gross tonnage of forty tons or more and in the case of any other ship a gross tonnage of one hundred tons or more;

“minor ship” means a ship, not being a ship having a gross tonnage of less than fifteen tons, having in the case of a sailing ship a gross tonnage of less than forty tons and in the case of any other ship a gross tonnage of less than one hundred tons;

“mixed service” means service partly in a deck rating and partly in a general purpose rating;

“responsible authority” means in relation to a school or course the person in charge of that school or course as the case may be;

“satisfactorily” means to the satisfaction of the responsible authority;

“service in a deck rating” means service in a deck rating in a ship other than a ship having a general purpose or integrated crew;

“service in a general purpose rating” means service in a general purpose rating in a ship having a general purpose or integrated crew;

“Steering Certificate” means a Steering Certificate in the form or substantially in the form set out in the Eighth Schedule;

Eighth  
Schedule.

Sub. Leg.

“valid medical fitness certificate” means a certificate issued in accordance with the Shipping (Medical Examinations) Regulations.

- 3. (1)** The Director may—
- (a) on receipt of the prescribed fees; and
  - (b) on being satisfied that the requirements of these Regulations are met,

Classification of deck ratings and classes of certificates.

issue to an applicant a Certificate of Competency or a Certificate of Classification as appropriate.

(2) Certificates of Competency shall be issued in the following classes and may be subject to any limitation as to area of operation and description of ship endorsed thereon:

Seaman Class 1 (AB)  
Seaman Class 2

(3) Certificates of Classification shall be issued in the following classes:

Seaman Class 3  
Seaman Class 4

(4) Certificates other than Seaman Class 4 may be endorsed with the Navigational Watch Rating Endorsement in accordance with regulation 13.

(5) Certificates of Competency and Classification shall be in the form set out in the First and Second Schedules respectively.

First Schedule.  
Second Schedule.

**4.** A certificate of Competency as an A.B. granted under the Merchant Shipping (Certificates of Competency as A.B.) (Trinidad and Tobago) Regulations, 1960, shall be treated as equivalent to a Certificate of Competency Seaman Class 1 issued under these Regulations.

Certificates equivalent.

**5.** A deck rating may be classified as a Seaman Class 4 where—

Seaman Class 4.

- (a) he has attained the age of sixteen years;
- (b) he has successfully completed an approved pre-sea training course; and
- (c) he is medically fit.

Seaman  
Class 3.

**6.** (1) A deck rating may be classified as a Seaman Class 3 where—

- (a) he has attained the age of sixteen years;
- (b) he is certified as being able to steer;
- (c) he is medically fit; and
- (d) he either—
  - (i) has successfully completed an approved pre-sea training course and can prove four months satisfactory sea service in a deck capacity; or
  - (ii) can prove six months satisfactory qualifying sea service in a deck capacity before the coming into force of these Regulations.

Seaman  
Class 2.

**7.** (1) Except as provided in subregulation (2), a Certificate of Competency as a Seaman Class 2 shall not be issued to any person unless—

- (a) he has attained the age of eighteen years;
- (b) he has qualifying sea service of—
  - (i) twelve months in a deck capacity; or
  - (ii) eighteen months in a general purpose capacity; or
  - (iii) between twelve and eighteen months mixed service such that the component periods of service in a deck capacity and in a general purpose capacity respectively, expressed as percentages of the periods described in relation thereto in paragraphs (i) and (ii), total one hundred per cent;
- (c) he has passed the examination in the subjects specified in the syllabus set out in the Third Schedule;
- (d) he has a Steering Certificate showing that apart from periods of instruction he has taken turns at

Third  
Schedule.

the wheel in steering major ships for periods totalling not less than ten hours; and

(e) he is medically fit.

(2) A Certificate of Competency as a Seaman Class 2 may be issued to a person where—

(a) he can prove at least twenty-four months satisfactory qualifying sea service in a deck capacity before the coming into force of these Regulations and is the holder of the certificate specified in subregulation (1)(d); and

(b) he is medically fit.

**8.** (1) Except as provided in subregulation (2), a Certificate of Competency as a Seaman Class 1 shall not be granted to any person unless—

Seaman  
Class 1 (AB).

(a) he has attained the age of eighteen years;

(b) he has qualifying sea service of—

(i) twelve months in a deck capacity; or

(ii) eighteen months in a general purpose capacity; or

(iii) between twelve and eighteen months mixed service such that the component periods of service in a deck capacity and in a general purpose capacity respectively, expressed as percentages of the periods described in relation thereto in paragraphs (i) and (ii), total one hundred per cent;

(c) he has performed two years qualifying sea service in a deck or general purpose capacity in addition to the qualifying sea service required under subregulation 1(b);

(d) he has passed an examination in the subjects specified in the syllabus set out in the Third Schedule;

(e) he is the holder of a Certificate of Proficiency in survival craft or a Certificate of Efficiency as

LAWS OF TRINIDAD AND TOBAGO

MINISTRY OF THE ATTORNEY GENERAL AND LEGAL AFFAIRS

www.legalaffairs.gov.tt

636

Chap. 50:10

Shipping

[Subsidiary]

Shipping (Certification of Seamen) (Deck Ratings) Regulations

lifeboatman issued or recognised in accordance with the Shipping (Certificates of Proficiency in Survival Craft) Regulations, 1988;

- (f) he has a Steering Certificate showing that apart from periods of instruction, he has taken turns at the wheel in steering major ships for periods totalling not less than ten hours; and
- (g) he is medically fit.

(2) A Certificate of Competency as a Seaman Class 1 (AB) may be issued to a person where—

- (a) he can prove at least three years qualifying sea service in a deck capacity; and
- (b) he was on or before the coming into force of these Regulations serving in the capacity of AB or in an equivalent or superior deck capacity, for a period of not less than two years, in a ship for which an agreement with the crew is required under the Act; and
- (c) he is medically fit.

Examination and appointments of examiners.

**9.** (1) Examinations for the certification of Seaman Classes 1 and 2 as required under regulations 7 and 8 shall be conducted by Examiners appointed for this purpose by the Minister.

(2) The syllabus for the examination is as specified in the Third Schedule.

Application for examination and issue of Certificate of Competency.

**10.** (1) Unless otherwise exempted by the Director, an applicant for examination shall be a national of Trinidad and Tobago or a national of a Caricom State.

(2) Application for examination shall be made to the Maritime Services Division on the form prescribed in the Fourth Schedule and shall be accompanied by—

Fourth Schedule.

- (a) the appropriate fee prescribed in the Seventh Schedule;
- (b) proof of satisfactory attendance at an approved basic sea survival course;

Seventh Schedule.

UNOFFICIAL VERSION

UPDATED TO 31ST DECEMBER 2016

- (c) proof of nationality and date and place of birth satisfactory to the Director;
- (d) a valid medical fitness certificate;
- (e) a Steering Certificate showing that apart from periods of instruction he has taken turns at the wheel in steering major ships for periods totalling not less than ten hours;
- (f) satisfactory proof of the sea service required in regulation 7(1)(b) as evidenced by Certificates of Discharge and such other certificates signed by the masters of ships in which the applicant has served as may be necessary to establish to the satisfaction of the Director that the applicant has performed the necessary qualifying service;
- (g) where remission of sea service is being claimed under regulation 12, certificates given by the responsible authority stating that the appropriate course has been satisfactorily completed and the dates of commencement and completion of the course.

(3) Every application for examination duly completed shall be lodged with the Director who shall, if satisfied that the applicant is eligible to take the examination, notify the applicant in due course of the arrangements made for his examination, or, if not so satisfied, inform the applicant in writing that his application is refused and the reasons for the refusal.

(4) On completion of every examination the examiner shall inform the applicant of the result thereof and shall record the result on his application and return the form to the Director for the issue of an appropriate Certificate of Competency, where the applicant has successfully completed the examination.

**11.** (1) Qualifying sea service shall be service performed in ships which proceed to sea and are actively engaged in commercial trading but shall not include service in—

Qualifying sea service.

- (a) fishing vessels;
- (b) ships trading primarily in the Gulf of Paria.

(2) Every period of qualifying sea service shall include a proportion of sea-going service in a major ship amounting to not less than twenty-five per cent of the qualifying sea service.

(3) In calculating the length of the periods of qualifying sea service for the purpose of regulations 6, 7, 8 and 9—

- (a) a period of service in a minor ship shall count as one-half of the period actually so served;
- (b) service in a ship having a gross tonnage of less than fifteen tons shall be disregarded;
- (c) every day by which a period of actual service in a ship exceeds the number of months comprised in that period, and every day of such service comprised in a period of actual service of less than one month, shall be treated as one-thirtieth of a month of actual service;
- (d) the length of every period of actual service in a ship shall be calculated separately from the date of its commencement to the date of its termination.

(4) Qualifying sea service shall be performed within a period of ten years immediately preceding the date upon which the examination is taken or a certificate applied for, subject to the discretion of the Director.

(5) Every period of qualifying sea service being claimed must be supported by certificates of discharge and such other certificates signed by the masters of ships in which the applicant has served as may be necessary to establish to the satisfaction of the Director that the applicant has performed the necessary qualifying sea service.

(6) Where a candidate can show to the satisfaction of the Director that it is not possible to produce the certificates referred to in subregulation (5) then the Director may accept such other documentary evidence of sea service as he deems fit.

(7) Notwithstanding subregulations (1)(b) and (2), where the sea service is performed in major ships trading primarily in the Gulf of Paria or in minor ships trading in the waters of Trinidad and Tobago, the Director in his discretion may accept such service as qualifying sea service for the issue of a certificate endorsed for service in a major or minor ship and as to the area of operation as appropriate.

**12.** (1) Subject to the provisions of subregulation (3) a person producing a certificate given by the responsible authority showing that he has satisfactorily completed a course of training at an approved nautical training school shall be entitled to a reduction—

Reduction of  
qualifying sea  
service.

- (a) in the case of a pre-sea training course, in the period of qualifying sea service required under regulations 7(1)(b) and 8(1)(b) of up to two weeks;
- (b) in the case of an Able Seaman training course, in the period of qualifying sea service required under regulation 8(1)(c) of one month for each period of four weeks attendance and training on that course, up to a maximum of three months, less any reduction made pursuant to subregulation (1)(a).

(2) A person who has served at sea in an engine room capacity and has satisfactorily completed an approved conversion course providing training in the duties of a deck capacity for persons who have served in an engine room capacity shall, on producing satisfactory evidence of such service and a certificate given by the responsible authority that he has satisfactorily completed the conversion course, be entitled to a reduction in the period of qualifying service required under regulation 8(1)(c) of—

- (a) one week for every complete week's attendance and training on the conversion course for a maximum of four weeks; and
- (b) fifty per cent of the total length of his sea service in an engine room capacity for a maximum of six months.

LAWS OF TRINIDAD AND TOBAGO

MINISTRY OF THE ATTORNEY GENERAL AND LEGAL AFFAIRS

www.legalaffairs.gov.tt

640

Chap. 50:10

Shipping

[Subsidiary]

Shipping (Certification of Seamen) (Deck Ratings) Regulations

(3) No person shall be entitled by virtue of the provisions of subregulation (1) to reductions of qualifying service exceeding a total of six months.

Navigational  
Watch Rating  
endorsement.

Fifth  
Schedule.

**13.** (1) On the issue of a Certificate of Competency or Classification in a deck rating, or subsequently, the Director may, if satisfied that the person to whom it is issued meets the qualifications specified in the Fifth Schedule, cause the certificate to be endorsed “Navigational Watch Rating”.

(2) The endorsement in subregulation (1) may be subject to a limitation where the seaman is not qualified in the use of gyro compass or automatic pilot equipment.

(3) A person who complies with the requirements of paragraph 2(1)(b) or (c) of the Fifth Schedule shall, on application for an endorsement, produce the records of navigational watch rating experience, in the form set out in the Appendix to the Fifth Schedule, as may be necessary to establish to the satisfaction of the Director that the applicant has met the necessary requirements.

Application for  
Certificates of  
competency or  
Classification.

**14.** (1) A person who—

- (a) has successfully completed the examination specified in the Third Schedule and subsequently qualifies for the issue of a Seaman Class 1 Certificate of Competency; or
- (b) qualifies for the issue of a Certificate of Competency in accordance with regulation 7(2) or 8(2),

may apply to the Maritime Services Division for the issue of an appropriate Certificate of Competency in the form prescribed in the Sixth Schedule.

Sixth  
Schedule.

(2) Any person who qualifies for the issue of a Certificate of Classification under regulation 5 or 6 may apply to the Maritime Services Division on the form prescribed in the Sixth Schedule for the issue of the appropriate certificate.

UNOFFICIAL VERSION

UPDATED TO 31ST DECEMBER 2016

(3) Every application duly completed shall be lodged with the Director who shall, if satisfied that the applicant is entitled to the grant of a Certificate of Competency or Classification, cause such a certificate to be issued to the applicant, or, if not so satisfied, inform the applicant in writing that his application is refused and the reasons for the refusal.

**15.** A record of all Certificates of Competency or Classification as a deck rating issued under these Regulations and of the suspension, cancellation or alteration of, and any other matters affecting any such certificate shall be kept, in such manner as the Minister may require, by the Director or by such other person as the Minister may direct. Record of certificates.

**16.** (1) Where a person entitled to a Certificate of Competency or Classification as a deck rating proves to the satisfaction of the Director that he has, without fault on his part, lost or been deprived of a certificate already issued to him, the Director shall, and where he is not so satisfied may, on receipt of any fee payable, cause a copy of the certificate to which the said person appears to be entitled to be issued to him. Loss of certificates.

(2) Any copy referred to in subsection (1) shall, before it is issued, be certified by the Director or, by such person as the Minister may have directed to keep the record referred to in regulation 15.

**17.** The fees specified in the Seventh Schedule shall be payable in respect of the matters specified in relation thereto in that Schedule. Fees.

Regulation 3(5).

**FIRST SCHEDULE**

REPUBLIC OF TRINIDAD AND TOBAGO

**FORM OF CERTIFICATE OF COMPETENCY AS  
A DECK RATING**

*The Shipping Act, Chap. 50:10*

PHOTOGRAPH

No.

Granted under the provisions of the Shipping (Certification of Seamen) (Deck Ratings) Regulations, 1993 made under section 87 of the Shipping Act, 1987.

Name in Full	Date of Birth	Place of Birth	Discharge Book No.

This is to certify that the above-named has been found duly qualified in accordance with the above-mentioned regulations to hold this Certificate of Competency as a Deck Rating.

\*Seaman Class 1 (AB)

\*Seaman Class 2

ENDORSEMENT (if any)

Dated this ..... day of ..... 20.....

.....  
*Director of Maritime Services*

.....  
*Official Stamp*

*Signature of Seaman* .....

.....  
\*Delete whichever is inapplicable.

UNOFFICIAL VERSION

UPDATED TO 31ST DECEMBER 2016

**SECOND SCHEDULE**

Regulation 3(5).

REPUBLIC OF TRINIDAD AND TOBAGO

**FORM OF CERTIFICATE OF CLASSIFICATION AS  
A DECK RATING**

*The Shipping Act, Chap. 50:10*

PHOTOGRAPH
------------

No.
-----

Granted under the provisions of the Shipping (Certification of Seamen) (Deck Ratings) Regulations, 1993 made under section 87 of the Shipping Act, 1987.

Name in Full	Date of Birth	Place of Birth	Discharge Book No.

This is to certify that the above-named has been found duly qualified in accordance with the above-mentioned regulations to hold this Certificate of Classification as a Deck Rating.

\*Seaman Class 3

\*Seaman Class 4

ENDORSEMENT (if any)

Dated this ..... day of ..... 20.....

.....  
*Director of Maritime Services*

.....  
*Official Stamp*

*Signature of Seaman* .....

\*Delete whichever is inapplicable.

**LAWS OF TRINIDAD AND TOBAGO**

MINISTRY OF THE ATTORNEY GENERAL AND LEGAL AFFAIRS

www.legalaffairs.gov.tt

644

**Chap. 50:10**

*Shipping*

**[Subsidiary]**

*Shipping (Certification of Seamen) (Deck Ratings) Regulations*

Regulation 9(2).

**THIRD SCHEDULE**

**SYLLABUS FOR THE EXAMINATION FOR  
A CERTIFICATE OF COMPETENCY  
AS SEAMAN DECK RATING**

*Section A—Shipboard Safety (General)*

1. Use of life-saving appliances.
2. Pyrotechnic distress signals.
3. Shipboard emergency signals and duties.
4. Use of internal communications and alarm systems.
5. Basic first aid.
6. Use of fire fighting appliances.

*Section B—Personal Safety and Survival*

7. Safe working practices.
8. Cleanliness and hygiene.
9. Basic sea survival.

*Section C—Nautical Knowledge*

10. The meaning of common ship-board and nautical terms.
11. The names and functions of various parts of the ship, for example, deck, compartments, bulkheads, ballast tanks, bilges, strum boxes, sounding pipes, air pipes, etc.
12. Knowledge of the compass card in points and degrees, ability to steer and to understand helm orders, use of magnetic and gyro compasses.
13. Ability to keep a proper lookout by sight and hearing and to report the approximate bearing of a sound signal, light, or other object, in degrees or points.

UNOFFICIAL VERSION

UPDATED TO 31ST DECEMBER 2016

14. Ability to understand orders and make himself understood in matters relevant to the seaman's duties.

15. Autopilot and the change-over from automatic to hand steering and vice versa.

16. Basic awareness of the types of log in common use on board ship.

17. Sounding machines and other bridge equipment.

18. Marking of the anchor cable.

*Section D—Pollution Prevention*

19. Basic knowledge of duties and responsibilities regarding the prevention of the pollution of the seas and harbours.

*Section E—Practical Work*

Tested as far as possible by practical demonstration.

20. Knots, hitches and bends in common use example, reef knot, timber hitch, clove hitch, rolling hitch, figure of eight, wall and crown, bowline and bowline on the bight, sheet bend—double and single, sheepshank, round turn and two half hitches, marlinespike hitch.

To whip a rope's end using plain or palm and needle whipping, to put a seizing on rope and wire, to put a stopper on a rope or wire hawser and derrick lift.

21. Splicing plaited and multi-strand manila and synthetic fibre rope, eye splice, short splice and back splice, splicing wire rope, eye splicing using a locking tuck, care in use of rope and wire.

22. Slings a stage, rigging a bosun's chair and pilot ladder.

Rigging and safe use of pilot hoists.

Rigging a derrick, driving a winch, general precautions to be taken before and during the operation of a winch whether used for working cargo or for warping.

23. Using deck cranes.

24. The use and operation of a windlass in anchor work and in warping, safe handling of moorings with particular reference to synthetic fibre ropes and self tensioning winches, precautions to be taken in the stowage of chain cable and securing the anchors for sea.

**LAWS OF TRINIDAD AND TOBAGO**

MINISTRY OF THE ATTORNEY GENERAL AND LEGAL AFFAIRS

www.legalaffairs.gov.tt

646

**Chap. 50:10**

*Shipping*

**[Subsidiary]**

*Shipping (Certification of Seamen) (Deck Ratings) Regulations*

25. A knowledge of the gear used in cargo work and an understanding of its uses, general maintenance with particular reference to wires, blocks and shackles, securing of cargo.

26. The safe handling of hatch covers including mechanical hatch covers, battening down and securing hatches and tank lids.

*Section F—Lifeboats and Liferafts*

27. Where no Certificate of Proficiency in survival craft is held, a candidate will be required to satisfy the examiner that—

- (a) he understands the general principles of boat management and can carry out orders relating to lifeboat launching and operation and the handling of a boat under sail;
- (b) he is familiar with a lifeboat and its equipment and the starting and running of the engines of a power boat;
- (c) he is familiar with the various methods of launching liferafts, the precautions to be taken before and during launching, methods of boarding and survival procedure.

---

UNOFFICIAL VERSION

UPDATED TO 31ST DECEMBER 2016

**FOURTH SCHEDULE** Regulation 10(2).

REPUBLIC OF TRINIDAD AND TOBAGO

**FORM OF APPLICATION FOR EXAMINATION FOR  
A CERTIFICATE OF COMPETENCY  
AS A DECK RATING**

*(Application should be made to the Maritime Services Division at least  
three weeks before the examination date)*

SECTION A—PARTICULARS OF APPLICANT

Name in Full: Surname ..... Other Names .....

Address .....

.....

*Discharge Book No.* *Date of Birth* *Place of Birth*

Rank/Rating .....

Nationality .....

Other Marine Qualifications Held  
(if any)

.....

.....

.....

.....

.....

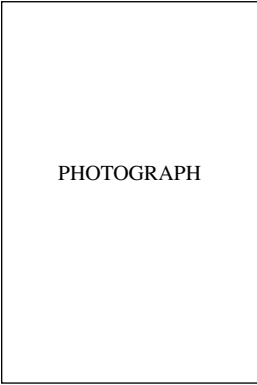

SECTION B—PREVIOUS CERTIFICATES

Have you attempted this examination before?

Yes / No/ If yes, give date .....

LAWS OF TRINIDAD AND TOBAGO

MINISTRY OF THE ATTORNEY GENERAL AND LEGAL AFFAIRS

www.legalaffairs.gov.tt

648

Chap. 50:10

Shipping

[Subsidiary]

Shipping (Certification of Seamen) (Deck Ratings) Regulations

Notes to applicant

1. If “Yes” complete only sections A, B and E in full and—
  - (a) complete section C regarding medical fitness certificate and, where applicable, Certificate of Proficiency in Survival Craft;
  - (b) show in section D only the sea service completed since your previous attempt.
2. If “No” then sections A, B, C, D and E must be completed.
3. In all cases the appropriate fee must be paid and a valid medical fitness certificate produced.

SECTION C—SUPPORTING DOCUMENTS

The following documents are submitted with this application:

	<b>(Official use only) Examiner’s Remarks</b>
1. Certificate of attendance at a basic sea survival course	//
2. Birth Certificate or other proof of age	//
3. Passport or other proof of Nationality	//
4. Medical Fitness Certificate	//
5. Certificate of attendance at an approved maritime safety training course (applicable only where remission of sea service is being claimed)	//
6. Discharge Book, Certificates of Discharge or other documentary evidence of sea service	//
7. Steering Certificate	//
8. Two passport size photographs	//
9. Certificate of Proficiency in Survival Craft	//

UNOFFICIAL VERSION

UPDATED TO 31ST DECEMBER 2016



**LAWS OF TRINIDAD AND TOBAGO**

MINISTRY OF THE ATTORNEY GENERAL AND LEGAL AFFAIRS

www.legalaffairs.gov.tt

650

**Chap. 50:10**

*Shipping*

**[Subsidiary]**

*Shipping (Certification of Seamen) (Deck Ratings) Regulations*

**SECTION E—DECLARATION OF APPLICANT**

(Any person making a false declaration is guilty of an offence and is liable to a fine and imprisonment under the Shipping Act, Chap. 50:10).

**DECLARATION:** I hereby declare that the information given in this application is to the best of my knowledge true and complete.

Signature of Applicant .....

Date .....

**THE FOLLOWING SECTIONS ARE FOR OFFICIAL USE ONLY**

**SECTION F—FEES**

I hereby certify that the examination fee of \$ ..... has been received.

Signature .....

Title .....

(Cashier, etc.)

Date .....



*Official Stamp*

Maritime Services Division

**SECTION G—SUMMARY AND EVALUATION OF SEA SERVICE**

The sea service, based on the statement of service given in section D, with supporting documents, is as follows:

Total qualifying sea service in major ships [Reg. 11(2)] .....

Total qualifying sea service in minor ships [Reg. 11(3)(a)] .....

Reduction of sea service (Reg. 12) .....

Other service (e.g., Gulf of Paria service) .....

**REMARKS:**



*Official Stamp*

Signed ..... Examiner

Name .....

Date .....

Maritime Services Division

UNOFFICIAL VERSION

UPDATED TO 31ST DECEMBER 2016

SECTION H—RESULT OF EXAMINATION

I have today examined ..... for the Certificate of  
(Name of Candidate)

Competency as a Deck Rating, with the following result: PASS/FAIL

The Certificate, when issued, should bear the following endorsement:

ENDORSEMENT:



Official Stamp

Signature of Examiner .....

Name of Examiner .....

Date .....

Maritime Services Division

SECTION I—AUTHORITY TO ISSUE CERTIFICATE

(To be completed by the Examiner, detached and given to successful candidate)

This is to certify that ..... passed the examination for  
(Name of Candidate)

the Certificate of Competency as a Deck Rating held on .....  
and may be issued with the Certificate as a Seaman Class 1 (A.B.)\*/Seaman Class 2.

\*Delete whichever is inapplicable.

The Certificate when issued, should bear the following endorsement.

ENDORSEMENT:



Official Stamp

Signature of Examiner .....

Name of Examiner .....

Date .....

Maritime Services Division

Note to Candidate:

To obtain your Certificate of Competency as a Deck Rating, this authority,  
together with proof of identity and the appropriate fee for the issue of the Certificate,  
should be produced to the office of the Maritime Services Division.

Signed ..... (Candidate)

Date .....

Maritime Services Division

**LAWS OF TRINIDAD AND TOBAGO**

MINISTRY OF THE ATTORNEY GENERAL AND LEGAL AFFAIRS

www.legalaffairs.gov.tt

652

**Chap. 50:10**

*Shipping*

**[Subsidiary]**

*Shipping (Certification of Seamen) (Deck Ratings) Regulations*

Regulation 13.

**FIFTH SCHEDULE**

**NAVIGATIONAL WATCH RATINGS**

General.

1. (1) Ratings who meet the qualifications specified in this Schedule may form part of a navigational watch on seagoing ships of 200 GT or more other than fishing vessels or pleasure craft.

(2) Other ratings may participate in navigational watchkeeping duties as part of their training under the supervision of a qualified officer or rating.

Requirements.

2. (1) To qualify for a Navigational Watch Rating endorsement a rating must—

- (a) be the holder of a valid Certificate of Competency of Class 1, 2 or Certificate of Classification Class 3; and
- (b) have experience or training which includes—
  - (i) not less than six months seagoing experience associated, in particular, with navigational watchkeeping duties, service exclusively in the Gulf of Paria being counted at half rate;
  - (ii) basic principles of fire fighting, first aid, personal survival techniques, health hazards and personal safety—obtained at an approved training establishment;
  - (iii) the ability to understand and carry out orders, and to make himself understood by the officer of the watch in matters relevant to his duties;
  - (iv) subject to paragraph 4, the ability to steer and comply with helm orders, and knowledge of magnetic and gyro compasses sufficient for the performance of these duties;
  - (v) the ability to keep a proper look-out by sight and hearing and to report the approximate bearing of a light or other object or of a sound signal, in degrees and points;
  - (vi) subject to paragraph 4, familiarity with the change-over from automatic pilot to hand steering and vice versa;
  - (vii) knowledge of the internal communications and alarm systems;
  - (viii) knowledge of pyrotechnic distress signals;
  - (ix) knowledge of his emergency duties;
  - (x) knowledge of nautical terms and their meanings appropriate to his duties;
  - (xi) basic knowledge of duties and responsibilities regarding the prevention of pollution of the seas and harbours; or

UNOFFICIAL VERSION

UPDATED TO 31ST DECEMBER 2016

(c) have served in the deck department in a navigational watchkeeping capacity for at least one year within the five years preceding the coming into operation of these Regulations.

(2) The experience and knowledge required in paragraph (b)(iii) to (xi) may be acquired through the performance of duties associated with navigational watchkeeping, subject to their having been carried out under the direct supervision of the master, officer in charge of the navigational watch, or a qualified navigational watchkeeping rating.

3. A record of experience as a navigational watch rating, in the form set out in the Appendix, may be issued to a rating where—

Record of navigational watch rating experience.

- (a) the master of a ship in which a rating has served is satisfied that the rating meets any part of the requirements of paragraph 2(1)(b) and the record shall be signed by the master and by the rating; or
- (b) it is established that the rating meets the requirements of paragraph 2(1)(c) and the record shall be signed by the rating and by the employer or master issuing the record.

4. A rating who has been unable to gain experience of gyro compasses or automatic pilots, but who otherwise satisfies the requirements of paragraph 2(1)(b), may qualify for a Navigational Watch Rating Endorsement where it is limited as follows:

Limitations.

“Not qualified in the use of gyro compass/automatic pilot”, as appropriate.

When such a rating gains this experience a new certificate without the limiting endorsement may be issued and the original destroyed. In the meantime the rating concerned may only form part of a navigational watch requiring knowledge of the equipment in which his experience or training is deficient under the direct supervision of the master, officer in charge of the watch, or a qualified navigational watchkeeping rating.

5. It is also recommended, in accordance with the terms of Resolution 8 adopted by the 1978 International Conference on Training and Certification of Seafarers, that ratings forming part of a navigational watch be trained in—

Recommended training.

- (a) the use and operation of bridge equipment appropriate to their duties; and
- (b) the basic requirements for prevention of pollution of the marine environment.

This training is not a requirement for the issue of a Navigational Watch Rating Endorsement.

LAWS OF TRINIDAD AND TOBAGO

MINISTRY OF THE ATTORNEY GENERAL AND LEGAL AFFAIRS

www.legalaffairs.gov.tt

654

Chap. 50:10

Shipping

[Subsidiary]

Shipping (Certification of Seamen) (Deck Ratings) Regulations

APPENDIX

RECORD OF NAVIGATIONAL WATCH RATING EXPERIENCE

Name of Rating .....

(Block Capitals)

Discharge Book No. ....

Signature of Rating.....

This is to certify that the above-named rating—

- (a) has served in the deck department in a watchkeeping capacity for at least one year within the five years immediately prior to the coming into force of these Regulations; or
(b) has been engaged with navigational watchkeeping duties for a period of ... days/months, and—
(i) is able to understand and carry out orders, and to make himself understood by the officer of the watch in matters relevant to his duties;
(ii) is able to steer and comply with helm orders, and has sufficient knowledge of the magnetic compass for the performance of watchkeeping;
(iii) has sufficient knowledge of the gyro compass for the performance of watchkeeping;
(iv) is familiar with the change over from automatic pilot to hand steering and vice versa;
(v) is able to keep a proper lookout by sight and hearing and to report the approximate bearing of a light or other object of a sound signal in degrees and points;
(vi) has knowledge of the internal communications and alarm systems;
(vii) has knowledge of pyrotechnic distress signals;
(viii) has knowledge of his emergency duties;
(ix) has knowledge of nautical terms and meanings appropriate to his duties; and
(x) has basic knowledge of duties and responsibilities regarding the prevention of pollution of the seas and harbours.

UNOFFICIAL VERSION

UPDATED TO 31ST DECEMBER 2016

*Shipping*

**Chap. 50:10**

**655**

*Shipping (Certification of Seamen) (Deck Ratings) Regulations*

**[Subsidiary]**

Signed .....

Name (Block capitals) .....

*Employer / Master\**

Date ..... Ship or Company Stamp.

\*Delete whichever is inapplicable.

**SIXTH SCHEDULE**

Regulation 14.

**FORM OF APPLICATION FOR A CERTIFICATE OF  
COMPETENCY OR CLASSIFICATION AS  
A DECK RATING**

(Application should be made to the Maritime Services Division)

**SECTION A—PARTICULARS OF APPLICANT**

Name in Full: Surname ..... Other Names .....

Address .....

.....

.....

*Discharge Book No.      Date of Birth      Place of Birth*

Rank/Rating .....

Nationality .....

Other Marine Qualifications Held  
(if any)

.....

.....

.....

.....

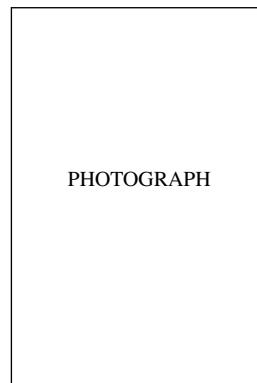

LAWS OF TRINIDAD AND TOBAGO

MINISTRY OF THE ATTORNEY GENERAL AND LEGAL AFFAIRS

www.legalaffairs.gov.tt

656

Chap. 50:10

Shipping

[Subsidiary]

Shipping (Certification of Seamen) (Deck Ratings) Regulations

SECTION B—PREVIOUS CERTIFICATES

Have you previously been issued with a Seaman Class 2 Certificate?

Yes // No // If yes, give date of issue .....

Notes to applicant

1. If “Yes” —

- (a) complete only sections A, B and E in full;
(b) complete section C regarding medical fitness certificate and Certificate of Proficiency in Survival Craft; and
(c) show in section D only the sea service completed since being issued with a Certificate Seaman Class 2.

2. If “No” then sections A, B, C, D and E must be completed.

3. In all cases the appropriate fee must be paid and a valid medical fitness certificate produced.

SECTION C—SUPPORTING DOCUMENTS

The following documents are submitted with this application:

Table with 2 columns: Document description and Remarks. Includes items like Certificate of attendance at a basic sea survival course, Birth Certificate, Passport, Medical Fitness Certificate, etc.

UNOFFICIAL VERSION

UPDATED TO 31ST DECEMBER 2016



**LAWS OF TRINIDAD AND TOBAGO**

MINISTRY OF THE ATTORNEY GENERAL AND LEGAL AFFAIRS

www.legalaffairs.gov.tt

658

**Chap. 50:10**

*Shipping*

**[Subsidiary]**

*Shipping (Certification of Seamen) (Deck Ratings) Regulations*

SECTION E—DECLARATION OF APPLICANT

(Any person making a false declaration is guilty of an offence and is liable to a fine and imprisonment under the Shipping Act, Chap. 50:10).

DECLARATION: I hereby declare that the information given in this application is to the best of my knowledge true and complete.

Signature of Applicant .....  
Date .....

**THE FOLLOWING SECTIONS ARE FOR OFFICIAL USE ONLY**

SECTION F—SUMMARY AND EVALUATION OF SEA SERVICE

The sea service, based on the statement of service given in section D, with supporting documents, is as follows:

- Total qualifying sea service in major ships [Reg. 11(2)] .....
- Total qualifying sea service in minor ships [Reg. 11(3)(a)] .....
- Remission of sea service (Reg. 12) .....
- Other service (e.g., Gulf of Paria service)

REMARKS:



Signed .....  
Name .....  
Date .....

Maritime Services Division

UNOFFICIAL VERSION

UPDATED TO 31ST DECEMBER 2016

SECTION G—AUTHORITY TO ISSUE CERTIFICATE

This is to certify that ..... may be issued with  
(Name of Applicant)

\*a Certificate of Classification as a Seaman Class 4

\*a Certificate of Classification as a Seaman Class 3

\*a Certificate of Competency as a Seaman Class 1

\_\_\_\_\_  
\*Delete whichever is inapplicable.

The Certificate when issued, should bear the following endorsement:

ENDORSEMENT:



Signature of Examiner .....

Name of Examiner .....

Date .....

Maritime Services Division

**SEVENTH SCHEDULE**

Regulation 17.

**FEES**

<i>Service</i>	<i>Fees</i>
	\$
1. For the examination for a Certificate of Competency as a Seaman ...	60.00
2. For the issue of—	
(a) a Certificate of Competency ... ..	40.00
(b) a Certificate of Classification ... ..	40.00
(c) a Navigational Watch Rating endorsement ... ..	30.00
3. The replacement of a certificate which has been lost or of an unendorsed certificate by one which is endorsed ... ..	40.00

**LAWS OF TRINIDAD AND TOBAGO**

MINISTRY OF THE ATTORNEY GENERAL AND LEGAL AFFAIRS

www.legalaffairs.gov.tt

660

**Chap. 50:10**

*Shipping*

**[Subsidiary]**

*Shipping (Certification of Seamen) (Deck Ratings) Regulations*

Regulation 2.

**EIGHTH SCHEDULE**

THE REPUBLIC OF TRINIDAD AND TOBAGO

**FORM OF STEERING CERTIFICATE**

**THE SHIPPING (CERTIFICATION OF SEAMEN)  
(DECK RATINGS) REGULATIONS, 1993**

Surname ..... Other Names .....

Discharge Book No. .... Rating .....

..... Signature of Seaman .....

This is to certify that the above-named seaman served as .....

from ..... to .....

\*being a ship

in the ..... , not being a fishing boat, having

being a sailing ship

\*of 100

a gross tonnage ..... tons or more and during that time took turns at the wheel in

of 40

steering the ship apart from periods of instruction, for periods amounting in the aggregate to ..... hours

*(in words)*

Date ..... Master .....

N.B.—Regulations 7(1)(d) and 8(1)(f) of these Regulations provide that an applicant for a Certificate of Competency as Deck Rating Class 1 or Class 2 must, apart from periods of instruction, have taken turns at the wheel in steering a ship, not being a fishing boat, having a gross tonnage of one hundred gross tons or more, in the case of a sailing ship a gross tonnage of forty tons or more, for periods totalling not less than ten hours.

Regulation 10(2)(e) provides that the above requirement must be complied with before a seaman can take the qualifying examination prescribed by regulations 7(1)(c) or 8(1)(d) and the First Schedule. This is the examination for which successful candidates receive a Class 2 or Class 1 Certificate.

\*Delete line which is inapplicable.

UNOFFICIAL VERSION

UPDATED TO 31ST DECEMBER 2016

---

**SHIPPING (PROVISIONS AND WATER)  
REGULATIONS**

ARRANGEMENT OF REGULATIONS

**REGULATION**

1. Citation.
2. Interpretation.
3. Application.
4. Duty to provide adequate provisions and water.
5. Duty to inspect provisions and water.
6. Offences and penalties.
7. Offences caused by act or default.
8. Inspection and detention of a Trinidad and Tobago ship.
9. Inspection, detention and other measures in respect of foreign ships.
10. Compensation and enforcement of detention.

---

[Subsidiary]

144/1993.

**SHIPPING (PROVISIONS AND WATER)  
REGULATIONS**

*made under section 142*

Citation.           **1.** These Regulations may be cited as the Shipping (Provisions and Water) Regulations.

Interpretation.   **2.** In these Regulations—  
“owner” includes a demise or bareboat charterer and a managing owner;  
“fishing vessel” means a vessel used or intended to be used for catching fish for gain;  
“length” in relation to a ship means the greater of the following distances:  
    (a) the distance between the foreside of the stem and the axis of the rudder stock; or  
    (b) a distance measured from the foreside of the stem, being ninety-six per cent of the distance between that point and the aft side of the stern, the said points and measurements being taken respectively at and along a waterline at eighty-five per cent of the least moulded depth of the ship, the waterline, being taken to be parallel to the designed waterline in the case of a ship having a rake of keel;  
“offshore installation” means any installation which is maintained, or intended to be established, for underwater exploitation or exploration;  
“submersible craft” means any description of manned mobile submersible craft which is designed to maintain some or all of its occupants at or near atmospheric pressure.

Application.       **3.** (1) Subject to subregulation (2)—  
    (a) these Regulations, other than regulation 9, apply to seagoing Trinidad and Tobago ships; and  
    (b) regulations 1, 2, 3, 9 and 10 apply to non-Trinidad and Tobago seagoing ships, except fishing vessels, when in a port in Trinidad and Tobago.

- (2) These Regulations do not apply to—
- (a) ships under twenty-four metres in length;
  - (b) pleasure craft;
  - (c) submersible craft;
  - (d) offshore installations whilst on or within five hundred metres of their working stations.

(3) The Minister may grant exemptions from all or any of these Regulations as specified in the exemption for classes of cases or individual cases on such terms, if any, as specified.

(4) The Minister may, on giving reasonable notice, alter or cancel any exemption granted under subregulation (3).

**4.** The owner and master of every ship shall ensure that provisions and water are provided on their ship which—

Duty to provide adequate provisions and water.

- (a) are suitable in respect of quantity, nutritive value, quality and variety having regard to the size of the crew and the character and nature of the voyage;
- (b) do not contain anything which is likely to cause sickness or injury to health or which renders any provision or water unpalatable; and
- (c) are otherwise fit for human consumption.

**5.** The master or a person authorised by him, together with a member of the crew employed in catering on the ship, shall inspect the provisions and water, at least once a week, for the purpose of checking whether the provisions and water comply with regulation 4(a) to (c) and the results of such inspections shall be recorded in the Official Log Book of the ship.

Duty to inspect provisions and water.

**6.** (1) An owner who contravenes regulation 4 is guilty of an offence and liable to a fine of one thousand dollars.

Offences and penalties.

(2) A master who contravenes regulation 4 or 5 is guilty of an offence and liable to a fine of one thousand dollars.

LAWS OF TRINIDAD AND TOBAGO

MINISTRY OF THE ATTORNEY GENERAL AND LEGAL AFFAIRS

www.legalaffairs.gov.tt

664

Chap. 50:10

Shipping

[Subsidiary]

Shipping (Provisions and Water) Regulations

(3) It shall be a defence for a person charged in respect of a contravention of any of these Regulations, including a person charged under regulation 7, to show that he took all reasonable precautions and exercised all due diligence to avoid the commission of the offence.

Offences caused by act or default.

7. Subject to regulation 6(3), where an offence under any of these Regulations is committed, or would have been committed by a person due to the act or default of another person, that other person is guilty of an offence and may be charged with and convicted of the offence, whether or not proceedings are taken against the first-mentioned person.

Inspection and detention of a Trinidad and Tobago ship.

8. A person duly authorised by the Minister may inspect any ship to which these Regulations apply and where he is satisfied that there has been a failure to comply with these Regulations the ship may be detained until the health and safety of all employees and other persons aboard ship are secured, but the ship shall not in the exercise of these powers be detained or delayed unreasonably.

Inspection, detention and other measures in respect of foreign ships.

9. (1) A person duly authorised by the Minister may inspect any ship which is not a Trinidad and Tobago ship when the ship is in a Trinidad and Tobago port, and where he is satisfied that the ship does not conform to the standards required of Trinidad and Tobago ships by these Regulations, he may—

- (a) send a report to the government of the country in which the ship is registered, and a copy thereof to the Director General of the International Labour Office; and
- (b) where conditions on board are clearly hazardous to safety or health—
  - (i) take such measures as are necessary to rectify those conditions; or
  - (ii) detain the ship,

save that the measures specified in paragraphs (a) and (b) may be taken only when the ship has called at a Trinidad and Tobago port in the normal course of business or for operational reasons.

UNOFFICIAL VERSION

UPDATED TO 31ST DECEMBER 2016

(2) Where the person duly authorised takes either of the measures specified in subregulation (1)(b), he shall forthwith notify the nearest maritime, consular or diplomatic representative of the State whose flag the ship is entitled to fly.

(3) The person duly authorised shall not, in exercise of his powers under this Regulation, detain or delay the ship unreasonably.

**10.** Sections 317(2) and 387(2) to (4) of the Act, shall have effect in relation to a ship detained under these Regulations subject to the following modifications:

Compensation and enforcement of detention.

- (a) in section 317(2) by deleting the words—
  - (i) “, by reason of the condition of the ship or the act or default of the owner,”;
  - (ii) “and survey”;
  - (iii) “or survey”;
  - (iv) “of an unseaworthy ship” and substituting the words “a ship”; and
- (b) in section 387(2) to (4) by deleting the words “this Act” wherever they occur and substituting the words “the Shipping (Provisions and Water) Regulations, 1993”.

---

**SHIPPING (PASSENGER FERRY)  
REGULATIONS**

ARRANGEMENT OF REGULATIONS

**REGULATION**

1. Citation.

**PART 1**

**GENERAL**

2. Application.
3. Interpretation.

**PART 2**

**CERTIFICATION**

4. Safety Certificate and insurance to be in force.

**PART 3**

**DUTIES OF OPERATOR AND CAPTAIN**

5. Operating permits.
6. Duties of operator.
7. Duties of master.
8. Operational records.
9. Medical equipment.
10. Documents to be carried.

**PART 4**

**SUPPLEMENTARY PROVISIONS**

11. Right of access to terminals.
12. Safety of passengers and property.
13. Duty to obey master.
14. Power to prevent operating.
15. Revocation, etc., of certificates, etc.
16. Obstruction of persons.
17. Enforcement of directions.
18. Exemption.
19. Penalties.

**SHIPPING (PASSENGER FERRY) REGULATIONS**

238/1994.

*made under sections 356 and 406*

1. These Regulations may be cited as the Shipping (Passenger Ferry) Regulations. Citation.

**PART I**

**GENERAL**

2. These Regulations apply to vessels which are used for the carriage of passengers for reward on scheduled routes between ports in Trinidad and Tobago. Application.

3. In these Regulations— Interpretation.

“Act” means the Shipping Act;

“authorised person” means—

- (a) the Director of Maritime Services;
- (b) a surveyor appointed as such under the Shipping Act;
- (c) any person authorised in writing by the Minister either generally or in relation to a particular case or class of cases;

“the Director” has the same meaning assigned to that word in section 2 of the Act;

“Maritime Services Division” means the Division of Maritime Services established under section 403 of the Act;

“master” has the same meaning assigned to that word in section 2 of the Act;

“Minister” means the Minister to whom responsibility for shipping is assigned;

“operator” in relation to a passenger ferry means the person for the time being having the management of the passenger ferry;

“passenger” has the same meaning as in section 2 of the Act;

“passenger ferry” means a passenger vessel employed on scheduled voyages between ports in Trinidad and Tobago;

**LAWS OF TRINIDAD AND TOBAGO**

MINISTRY OF THE ATTORNEY GENERAL AND LEGAL AFFAIRS

www.legalaffairs.gov.tt

668

**Chap. 50:10**

*Shipping*

[Subsidiary]

*Shipping (Passenger Ferry) Regulations*

“passenger ship” has the same meaning as in section 2 of the Act;  
“terminal” means an area which is designed, equipped, set apart or commonly used for affording facilities for the arrival or departure of passengers on a passenger ferry.

**PART 2**

**CERTIFICATION**

Safety  
Certificate and  
insurance to be  
in force.

**4.** A passenger ferry shall not be used unless there is in force respect thereof—

- (a) a Passenger Ship Safety Certificate recognised under section 243 of the Act;
- (b) a Load Line Certificate; and
- (c) a certificate providing evidence of financial responsibility against the risks of damage to third parties.

**PART 3**

**DUTIES OF OPERATOR AND CAPTAIN**

Operating  
permits.

**5.** (1) A passenger ferry shall not be used for reward or in connection with a trade or business, otherwise than under and in accordance with a permit (hereinafter referred to as an “operating permit”) granted to the operator of the passenger ferry under subregulation (2) and operating permits shall be granted with a view of securing the safe operation of the ferry.

(2) The Minister may grant or renew to any person applying therefor an operating permit for the operation of a passenger ferry of the types and in relation to the areas of operation specified in the operating permit for the purposes so specified.

(3) The operating permit may be granted subject to such conditions as the Minister thinks fit to impose with a view to securing the safe operation of passenger ferries and shall remain in force for such time as may be specified in the operating permit or until suspended or revoked by the Minister and may be renewed from time to time by the Minister for such further period as he thinks fit.

UNOFFICIAL VERSION

UPDATED TO 31ST DECEMBER 2016

(4) The Minister may vary an operating permit on application by the holder.

(5) The conditions to which the operating permit may be subject may include, without prejudice to the generality of the foregoing subregulation, conditions in respect of the following matters:

- (a) crew complement and qualifications;
- (b) type of ferry;
- (c) area of operation;
- (d) restrictions with regard to working hours and rest periods of crew;
- (e) safety arrangements at terminal areas;
- (f) the weather conditions in which the ferry may operate;
- (g) day or night operation;
- (h) life-saving equipment and procedures;
- (i) other equipment and procedures necessary for safety of operation;
- (j) radio and radar;
- (k) the keeping of records; and
- (l) medical equipment to be carried.

**6.** (1) The operator of a passenger ferry shall not permit the vessels to be used without first— Duties of operator.

- (a) ensuring that a minimum number of the crew corresponding to the complement necessary for the journey are adequately trained for their duties for that voyage; and
- (b) ensuring that the safety equipment required to be carried is in working order.

(2) Without prejudice to his other duties under these Regulations an operator shall at all times take all reasonable precautions at terminal areas so as to ensure the safety of persons and property in the ferry and at the terminal.

LAWS OF TRINIDAD AND TOBAGO

MINISTRY OF THE ATTORNEY GENERAL AND LEGAL AFFAIRS

www.legalaffairs.gov.tt

670

Chap. 50:10

Shipping

[Subsidiary]

Shipping (Passenger Ferry) Regulations

(3) An operator shall not permit any vessel to be used where he has reason to believe or suspect it is in an unsafe condition.

Duties of master.

7. The master, before the departure of the vessel—
- (a) shall take reasonable steps to ensure—
    - (i) that the craft is properly loaded and any cargo adequately secured in the craft; and
    - (ii) that the craft is in a fit state and that safety equipment required to be carried is in a fit condition and ready to be used; and
  - (b) shall satisfy himself that the journey can safely be made, taking into account the latest information available to him as to the weather.

Operational records.

8. (1) The master of every passenger ferry shall ensure that records are kept of the following matters relating to any voyage of the ferry:

- (a) weather conditions, such as wind, sea condition and visibility experienced;
- (b) any accidents or unusual occurrences on the journey; and
- (c) a summary of all communications relating to distress, urgency and safety traffic.

(2) The operator of every passenger ferry shall keep records of—

- (a) crew emergency and distress drills, including the names of persons present; and
- (b) the names of all crew aboard the ferry on any journey.

(3) The master or operator, as the case may be, shall within a reasonable time after being requested to do so by an authorised person, cause to be produced to that person the records referred to in subregulations (1) and (2) respectively.

(4) The records referred to in subregulations (1) and (2) shall be preserved by the operator for at least twelve months after any journey or drill to which they refer.

UNOFFICIAL VERSION

UPDATED TO 31ST DECEMBER 2016

(5) The records referred to in subregulation (1) shall be delivered to the operator of the passenger ferry to which the records relate by the master at the time he ceases to be the master, or when the operator requires their delivery.

(6) A person required to preserve any record by reason of his being the operator of a passenger ferry shall, where he ceases to be the operator of the ferry continue to preserve the record as if he had not ceased to be the operator, and in the event of his death the duty to preserve the record shall fall upon his personal representative.

**9.** A passenger ferry shall carry, when in use, first-aid equipment of good quality, sufficient in quantity having regard to the number of persons on board. Medical equipment.

**10.** (1) A passenger ferry shall, when in operation, carry the following documents or true copies thereof: Documents to be carried.

- (a) its Passenger Ship Safety Certificate;
- (b) its Certificate of Registration or Licence; and
- (c) its Load Line Certificate.

(2) The Passenger Ship Safety Certificate, Load Line Certificate or true copies thereof shall be posted in some conspicuous place in the vessel.

#### PART 4

#### SUPPLEMENTARY PROVISIONS

**11.** The Director and any authorised person shall have the right of access at all reasonable times to any terminals and any place where a passenger ferry is located for the purpose of inspecting any vessel or any document which they have power to demand under these Regulations and for the purpose of detaining any vessel under the provisions of these Regulations. Right of access to terminals.

**12.** A person shall not wilfully or negligently — Safety of passengers and property.

- (a) act in a manner likely to endanger a passenger ferry, or any person therein;

LAWS OF TRINIDAD AND TOBAGO

MINISTRY OF THE ATTORNEY GENERAL AND LEGAL AFFAIRS

www.legalaffairs.gov.tt

672

Chap. 50:10

Shipping

[Subsidiary]

Shipping (Passenger Ferry) Regulations

- (b) go or attempt to go on a journey on a passenger ferry without the consent of the master or other person authorised to give it.

Duty to obey master.

**13.** Every person in a passenger ferry shall obey all lawful commands which the master may give for the purpose of securing the safety of the vessel and of persons or property carried therein, or the safety, efficiency or regularity of navigation.

Power to prevent operating.

**14.** (1) Where it appears to the Director or an authorised person that any ferry is intended or likely to be operated—

- (a) in such circumstances that any provision of regulation 5 would be contravened in relation to the journey;
- (b) in such circumstances that the journey would be in contravention of any other provision of these Regulations and be a cause of danger to any person or property whether or not in the ferry; or
- (c) while in a condition unfit for operation whether or not the journey would otherwise be in contravention of any provision of these Regulations,

the Director or the authorised person may direct the operator or the master of the vessel that he is not to permit the vessel to make the particular journey or any other journey of such description as may be specified in the direction and the Director or the authorised person may take such steps as are necessary to detain the ferry.

(2) The Minister or the Director may revoke a direction made under subregulation (1).

(3) For the purposes of subregulation (1) the Director or any authorised person may enter upon and inspect any passenger ferry.

Revocation, etc., of certificates, etc.

**15.** (1) The Minister may, if he thinks fit, provisionally suspend any certificate, licence, approval, permission, exemption or other document issued, granted or having effect under the Act and these Regulations pending inquiry into or investigation of the case.

UNOFFICIAL VERSION

UPDATED TO 31ST DECEMBER 2016

(2) Without prejudice to regulation 5(2) the Minister may, on sufficient grounds being shown to his satisfaction after due inquiry, revoke, suspend or vary any such certificate, licence, approval, permission, exemption or other document.

(3) The holder or any person having the possession or custody of any certificate, licence, approval, permission, exemption or other document which has been revoked, suspended or varied under this regulation shall surrender it to the Minister within a reasonable time after being required to do so by him.

(4) The breach of any condition subject to which any certificate, licence, approval, permission, exemption or other document has been granted or issued, or which has effect under these Regulations shall render the document invalid during the continuance of the breach.

**16.** A person shall not wilfully obstruct or impede any authorised person acting in the exercise of his powers or the performance of his duties under these Regulations. Obstruction of persons.

**17.** Any person who fails to comply with any direction given to him by the Director or by any authorised person under these Regulations shall be deemed to have committed an offence. Enforcement of directions.

**18.** The Minister may exempt from any of the provisions of these Regulations any passenger ferry or persons or classes of passenger ferry or persons, either absolutely or subject to such conditions as he thinks fit. Exemption.

**19.** (1) Where any provision of these Regulations is contravened in relation to a passenger ferry, the operator of that ferry and the master thereof, shall, without prejudice to the liability of any other person under these Regulations for that contravention, be deemed, for the purposes of subregulations (3) to (5), to have committed an offence unless he proves that the contravention occurred without his consent or connivance and that he exercised all due diligence to prevent the contravention. Penalties.

(2) Where it is proved that an act or omission of any person which would otherwise have been a contravention by that

**LAWS OF TRINIDAD AND TOBAGO**

MINISTRY OF THE ATTORNEY GENERAL AND LEGAL AFFAIRS

www.legalaffairs.gov.tt

674

**Chap. 50:10**

*Shipping*

[Subsidiary]

*Shipping (Passenger Ferry) Regulations*

---

person of a provision of these Regulations was due to any cause not avoidable by the exercise of reasonable care by that person the act or omission shall be deemed not to be an offence.

(3) A person who contravenes any provision of these Regulations not being a provision referred to in subregulation (4) or (5), is guilty of an offence and is liable to a fine of two hundred and fifty dollars.

(4) A person who contravenes any provision of regulations 8, 10 and 15 is guilty of an offence and is liable to a fine of five hundred dollars.

(5) A person who contravenes any provision of regulations 4 to 7, 9, 12, 13 and 14 is guilty of an offence and is liable to a fine of one thousand dollars.

---

UNOFFICIAL VERSION

UPDATED TO 31ST DECEMBER 2016

**SHIPPING (SAFETY OF NAVIGATION)  
(CHAGUARAMAS BAY) REGULATIONS**

35/1995.

*made under section 406(i)*

**1.** These Regulations may be cited as the Shipping (Safety of Navigation) (Chaguaramas Bay) Regulations. Citation.

**2.** In these Regulations— Interpretation.

“master” includes every person having command or charge of any vessel, other than a pilot;

“owner” in relation to a vessel, means the person registered as the owner of the vessel or, in the absence of registration the person owning the ship or the bareboat charterer of the vessel;

“pilot” means a person who is granted a licence pursuant to the Pilotage Act;

Ch. 51:02.

“vessel” includes any ship or boat or any other description of vessel used or designed to be used in navigation.

**3.** No person, other than a pilot, shall anchor a vessel in the area defined in the Schedule. Restriction on anchoring. Schedule.

**4.** The owner or master of a vessel who contravenes regulation 3 is guilty of an offence and is liable to a fine of one thousand dollars. Penalty.

---

**SCHEDULE**

Regulation 3.

The area bounded by a line from a point on the Trinidad Coast in Chaguaramas Bay at the western end of the base of Pier No. 5; thence to a point on the easternmost part of Gasparillo Islet; thence to Reyna Pt. on the easternmost part of Gaspar Grande; thence to San Carlos Pt. on Point Gourde; thence due North to the beacon in position 10° 40' 21" North, 61° 38' 15" West; thence northward to the southern edge of the wharf; thence north-eastward to along the wharf and to a point 10° 40' 39" North, 61° 38' 05" West; thence to a point 10° 40' 41" North, 61° 37' 59" West; thence to a point 10° 40' 42" North, 61° 37' 59" West; thence to a point 10° 40' 40" North, 61° 38' 07" West; thence to a point 10° 49' 37" North, 61° 38' 16" West; thence to a point 10° 40' 37" North, 61° 38' 21" West; thence due North to the coast.

**SHIPPING (CERTIFICATION OF SEAMEN)  
(ENGINEERING RATINGS) REGULATIONS**

ARRANGEMENT OF REGULATIONS

**REGULATION**

1. Citation.
2. Definitions.
3. Classification of engineering ratings and category of certificates.
4. Engineering rating category 4.
5. Engineering rating category 3.
6. Engineering rating category 2.
7. Engineering rating category 1.
8. Examinations and appointment of examiners.
9. Application for examination and issue of certificate of competency.
10. Qualifying sea service.
11. Reduction of qualifying sea service.
12. Application for certificates of competency or classification.
13. Record of certificates.
14. Loss of certificates.
15. Fees.

**FIRST SCHEDULE.**

**SECOND SCHEDULE.**

**THIRD SCHEDULE.**

**FOURTH SCHEDULE.**

**FIFTH SCHEDULE.**

**SIXTH SCHEDULE.**

**SHIPPING (CERTIFICATION OF SEAMEN)  
(ENGINEERING RATINGS) REGULATIONS**

135/1995.

*made under section 87*

**1.** These Regulations may be cited as the Shipping (Certification of Seamen) (Engineering Ratings) Regulations. Citation.

**2.** In these Regulations— Definitions.

“Act” means the Shipping Act;

“approved” means approved by the Minister;

“Director” means the Director of Maritime Services as referred to in section 403(2)(a) of the Act;

“major ship” means a ship having in the case of a sailing ship a gross tonnage of forty tons or more and in the case of any other ship a gross tonnage of one hundred tons or more;

“Maritime Services Division” means the Division of Maritime Services established under section 403 of the Act;

“Minister” means the Minister to whom the responsibility for Shipping is assigned;

“mixed service” means service partly in a deck rating and partly in a general purpose rating;

“minor ship” means a ship, not being a ship having a gross tonnage of less than fifteen tons, having in the case of a sailing ship a gross tonnage of less than forty tons and in the case of any other ship a gross tonnage of less than one hundred tons;

“responsible authority” means in relation to a school or course the person in charge of that school or course as the case may be;

“satisfactorily” means to the satisfaction of the responsible authority;

“valid medical fitness certificate” means a certificate issued in accordance with the Shipping (Medical Examinations) Regulations; Sub. Leg.

“service in an engineering rating” means service in an engineering rating in a ship other than a ship having a general purpose or integrated crew;

LAWS OF TRINIDAD AND TOBAGO

MINISTRY OF THE ATTORNEY GENERAL AND LEGAL AFFAIRS

www.legalaffairs.gov.tt

678

Chap. 50:10

Shipping

[Subsidiary]

Shipping (Certification of Seamen) (Engineering Ratings) Regulations

“service in a general purpose rating” means service in a general purpose rating in a ship having a general purpose or integrated crew.

Classification of engineering ratings and category of certificates.

3. (1) The Director may—
- (a) on receipt of the prescribed fees; and
  - (b) on being satisfied that the requirements of these Regulations are met,

issue to an applicant a Certificate of Competency or a Certificate of Classification as appropriate.

(2) Certificates of Competency shall be issued in the following categories and may be subject to any limitation as to area of operation and description of ship endorsed thereon—

- (a) Engineering Rating Category 1; or
- (b) Engineering Rating Category 2.

(3) Certificates of Classification shall be issued in the following categories—

- (a) Engineering Rating Category 3; or
- (b) Engineering Rating Category 4.

(4) Certificates of Competency and Classification shall be in the form set out in the First and Second Schedules respectively.

First Schedule.  
Second Schedule.

Engineering rating category 4.

4. An engineering rating may be classified as an Engineering Rating Category 4 where the applicant—
- (a) has attained the age of sixteen years;
  - (b) has successfully completed an approved pre-sea training course; and
  - (c) is medically fit.

Engineering rating category 3.

5. (1) An engineering rating may be classified as an Engineering Rating Category 3 where—
- (a) the applicant has attained the age of sixteen years;
  - (b) the applicant is medically fit; and
  - (c) the applicant—
    - (i) has successfully completed an approved pre-sea training course and can prove four

UNOFFICIAL VERSION

UPDATED TO 31ST DECEMBER 2016

months satisfactory sea service in an engineering capacity; or

- (ii) can prove six months satisfactory qualifying sea service in an engineering capacity before the coming into force of these Regulations.

**6.** (1) Except as provided in subregulation (2), a Certificate of Competency as an Engineering Rating Category 2 shall not be issued to any person unless—

Engineering rating category 2.

- (a) he has attained the age of eighteen years;
- (b) he has qualifying sea service of—
  - (i) twelve months in an engineering capacity;
  - (ii) eighteen months in a general purpose capacity; or
  - (iii) between twelve and eighteen months mixed service such that the component periods of service in an engineering capacity and in a general purpose capacity respectively, expressed as percentages of the periods described in relation thereto in paragraphs (i) and (ii), total one hundred per cent;
- (c) he has passed the examination in the subjects specified in the syllabus set out in the Third Schedule; and
- (d) he is medically fit.

Third Schedule.

(2) A certificate of competency as an Engineering Rating Category 2 may be issued to a person where—

- (a) he can prove at least twenty-four months satisfactory qualifying sea service in an engineering capacity before the coming into force of these Regulations; and
- (b) he is medically fit.

**7.** (1) Except as provided in subregulation (2), a Certificate of Competency as an Engineering Rating Category 1 shall not be granted to any person unless—

Engineering rating category 1.

- (a) he has attained the age of eighteen years;

LAWS OF TRINIDAD AND TOBAGO

MINISTRY OF THE ATTORNEY GENERAL AND LEGAL AFFAIRS

www.legalaffairs.gov.tt

680

Chap. 50:10

Shipping

[Subsidiary]

Shipping (Certification of Seamen) (Engineering Ratings) Regulations

Third Schedule.

- (b) he has qualifying sea service of—
  - (i) twelve months in an engineering capacity; or
  - (ii) eighteen months in a general purpose capacity; or
  - (iii) between twelve and eighteen months mixed service such that the component periods of service in an engineering capacity and in a general purpose capacity respectively, expressed as percentages of the periods, described in relation thereto in paragraphs (i) and (ii), total one hundred per cent;
- (c) he has performed two years qualifying sea service in an engineering or general purpose capacity;
- (d) he has passed an examination in the subjects specified in the syllabus set out in the Third Schedule; and
- (e) he is medically fit.

(2) A Certificate of Competency as an Engineering Rating Category 1 may be issued to a person where—

- (a) he can prove at least three years qualifying sea service in an engineering capacity;
- (b) he was on or before the coming into force of these Regulations serving in the capacity of assistant to the Engineer Officer in charge of the watch or in an equivalent or superior engineering capacity, for a period of not less than two years, in a ship for which an agreement with the crew is required under the Act; and
- (c) he is medically fit.

Examinations and appointment of examiners.

**8.** (1) Examinations for the certification of Engineering Ratings Category 1 and 2 as required under regulations 6 and 7 shall be conducted by Examiners appointed for this purpose by the Minister.

UNOFFICIAL VERSION

UPDATED TO 31ST DECEMBER 2016

(2) The syllabus for the examination is as specified in the Third Schedule.

Third Schedule.

**9.** (1) Unless otherwise permitted by the Director an applicant for examination shall be a national of Trinidad and Tobago or a national of a Caricom State.

Application for examination and issue of certificate of competency.

(2) An application for Examination for a Certificate of Competency as an Engineering Rating shall be made to the Maritime Services Division on the form prescribed in the Fourth Schedule and shall be accompanied by—

Fourth Schedule.

- (a) the appropriate fee as prescribed in the Sixth Schedule;
- (b) proof of satisfactory attendance at an approved basic sea survival course;
- (c) proof of nationality and date and place of birth satisfactory to the Director;
- (d) a valid medical fitness certificate;
- (e) satisfactory proof of the sea service required in regulation 6(1)(b) as evidenced by Certificates of Discharge and such other certificates signed by the masters or chief engineers of ships in which the applicant has served as may be necessary to establish to the satisfaction of the Director that the applicant has performed the necessary qualifying service; and
- (f) where remission of sea service is being claimed under regulation 11, certificates given by the responsible authority stating that the appropriate course has been satisfactorily completed and the dates of commencement and completion of the course.

Sixth Schedule.

(3) Every application for examination duly completed shall be lodged with the Director who shall, if satisfied that the applicant is eligible to take the examination, notify the applicant in due course of the arrangements made for his examination, or, if not so satisfied, inform the applicant in writing that his application is refused and the reasons for the refusal.

(4) On completion of every examination the examiner shall inform the applicant of the result thereof and shall record the result on his form of application and return the form to the Director for the issue of an appropriate Certificate of Competency, where the applicant has successfully completed the examination.

Qualifying sea service.

**10.** (1) Qualifying sea service shall be service performed in ships which proceed to sea and are actively engaged in commercial trading but shall not include service in—

- (a) fishing vessels; and
- (b) ships trading primarily in the Gulf of Paria.

(2) Every period of qualifying sea service shall include a proportion of seagoing service in a major ship amounting to not less than twenty-five per cent of the qualifying sea service.

(3) In calculating the length of the periods of qualifying sea service for the purpose of regulations 5, 6, 7 and 8—

- (a) a period of service in a minor ship shall count as one-half of the period actually so served;
- (b) service in a ship having a gross tonnage of less than fifteen tons shall be disregarded;
- (c) every day by which a period of actual service in a ship exceeds the number of months comprised in that period, and every day of such service comprised in a period of actual service of less than one month, shall be treated as one-thirtieth of a month of actual service; and
- (d) the length of every period of actual service in a ship shall be calculated separately from the date of its commencement to the date of its termination.

(4) Qualifying sea service shall be performed within a period of ten years immediately preceding the date upon which the examination is taken or a certificate applied for, subject to the discretion of the Director.

(5) Every period of qualifying sea service being claimed must be supported by Certificates of Discharge and such other

certificates signed by the masters of ships in which the applicant has served as may be necessary to establish to the satisfaction of the Director that the applicant has performed the necessary qualifying sea service.

(6) Where a candidate can show to the satisfaction of the Director that it is not possible to produce the certificates referred to in subregulation (5) then the Director may accept such other documentary evidence of sea service as he deems fit.

(7) Notwithstanding subregulations (1)(b) and (2), where the sea service is performed in major ships trading primarily in the Gulf of Paria or in minor ships trading in the waters of Trinidad and Tobago, the Director in his absolute discretion may accept such service as qualifying sea service for the issue of a certificate endorsed for service in a major or minor ship and as to area of operation as appropriate.

**11.** (1) Subject to subregulation (3) a person producing a certificate given by the responsible authority showing that he has satisfactorily completed a course of training at an approved maritime training school shall be entitled to a reduction—

Reduction of  
qualifying sea  
service.

- (a) in the case of a pre-sea training course, in the period of qualifying sea service required under regulations 6(1)(b) and 7(1)(b) of up to two weeks; and
- (b) in the case of an Engineering Rating training course, in the period of qualifying sea service required under regulation 7(1)(c) of one month for each period of four weeks attendance and training on that course, up to a maximum of three months, less any reduction made pursuant to subregulation (1)(a).

(2) A person who has served at sea in a deck capacity and has satisfactorily completed an approved conversion course providing training in the duties of an engine room capacity for persons who have served in a deck capacity shall, on producing satisfactory evidence of such service and a certificate given by the responsible authority that he has satisfactorily completed the

conversion course, be entitled to a reduction in the period of qualifying service required under regulation 7(1)(c) of—

- (a) one week for every complete week's attendance and training on the conversion course subject to a maximum of four weeks; and
- (b) fifty per cent of the total length of his sea service in a deck capacity subject to a maximum of six months.

(3) No person shall be entitled by virtue of the provisions of subregulation (1) to a reduction or reductions of qualifying service exceeding a total of six months.

Application for certificates of competency or classification.

**12.** (1) A person who—

- (a) has successfully completed the examination specified in the Third Schedule and who subsequently qualifies for the issue of an Engineering Rating Category 1 Certificate of Competency; or
- (b) qualifies for the issue of a Certificate of Competency in accordance with regulation 6(2) or 7(2),

may apply to the Maritime Services Division for the issue of an appropriate certificate of competency on the form prescribed in the Fifth Schedule.

Fifth Schedule.

(2) Any person who qualifies for the issue of a Certificate of Classification under regulation 4 or 5 may apply to the Maritime Services Division on the form prescribed in the Fifth Schedule for the issue of the appropriate certificate.

(3) Every such application duly completed shall be lodged with the Director who shall, if satisfied that the applicant is entitled to the grant of a Certificate of Competency or Classification, cause such a certificate to be issued to the applicant, or, if not so satisfied, inform the applicant in writing that his application is refused and the reasons for the refusal.

Record of certificates.

**13.** A record of all Certificates of Competency or Classification as a deck rating issued under these Regulations and of the

suspension, cancellation or alteration of, and any other matters affecting, any such certificate shall be kept, in such manner as the Minister may require, by the Director of Maritime Services or by such other person as the Minister may direct.

**14.** (1) Where a person entitled to a Certificate of Competency or Classification as a deck rating proves to the satisfaction of the Director that he has, without fault on his part, lost or been deprived of a certificate already issued to him, the Director shall, and where he is not so satisfied may, on receipt of any fee payable, cause a copy of the certificate to which the said person appears to be entitled to be issued to him. Loss of certificates.

(2) A copy referred to in subsection (1) shall, before it is so issued, be certified as such by the Director of Maritime Services or, as the case may be, by such person as the Minister may have directed to keep the record referred to in regulation 13.

**15.** The fees specified in the Sixth Schedule shall be payable in respect of the matters specified in relation thereto in that Schedule. Fees. Sixth Schedule.

---

**LAWS OF TRINIDAD AND TOBAGO**

MINISTRY OF THE ATTORNEY GENERAL AND LEGAL AFFAIRS

www.legalaffairs.gov.tt

686

**Chap. 50:10**

*Shipping*

**[Subsidiary]**

*Shipping (Certification of Seamen) (Engineering Ratings) Regulations*

Regulation 3(4).

**FIRST SCHEDULE**

REPUBLIC OF TRINIDAD AND TOBAGO

**FORM OF CERTIFICATE OF COMPETENCY AS AN ENGINEERING RATING**

THE SHIPPING ACT, CH. 50:10

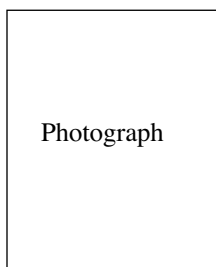

No.

Granted under the provisions of the Shipping (Certification of Seamen) (Engineering Ratings) Regulations made under section 87 of the Shipping Act (Ch. 50:10).

Name in Full	Date of Birth	Place of Birth	Discharge Book No.

This is to certify that the above-named has been found duly qualified in accordance with the above-mentioned regulations to hold this Certificate of Competency as an Engineering Rating.

- \*Engineering Rating Category 1
- \*Engineering Rating Category 2

ENDORSEMENT (if any)

Dated this .....day of....., 20.....

.....  
*Director of Maritime Services*

.....  
*Official Stamp*

Signature of Seaman.....

\*Delete whichever is inapplicable.

UNOFFICIAL VERSION

UPDATED TO 31ST DECEMBER 2016

SECOND SCHEDULE

Regulation  
3(4).

REPUBLIC OF TRINIDAD AND TOBAGO

FORM OF CERTIFICATE OF CLASSIFICATION AS AN ENGINEERING RATING

THE SHIPPING ACT, CH. 50:10

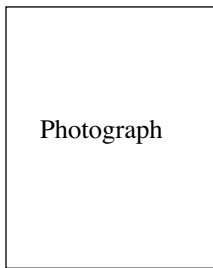

No.

Granted under the provisions of the Shipping (Certification of Seamen) (Engineering Ratings) Regulations made under section 87 of the Shipping Act (Ch. 50:10).

Name in Full	Date of Birth	Place of Birth	Discharge Book No.

This is to certify that the above-named has been found duly qualified in accordance with the above-mentioned regulations to hold this Certificate of Classification as an Engineering Rating.

\*Engineering Rating Category 3

\*Engineering Rating Category 4

ENDORSEMENT (if any)

Dated this .....day of....., 20.....

.....  
*Director of Maritime Services*

.....  
*Official Stamp*

Signature of Seaman.....

\*Delete whichever is inapplicable.

UNOFFICIAL VERSION

L.R.O.

UPDATED TO 31ST DECEMBER 2016

**LAWS OF TRINIDAD AND TOBAGO**

MINISTRY OF THE ATTORNEY GENERAL AND LEGAL AFFAIRS

www.legalaffairs.gov.tt

688

**Chap. 50:10**

*Shipping*

**[Subsidiary]**

*Shipping (Certification of Seamen) (Engineering Ratings) Regulations*

Regulation 8(2).

**THIRD SCHEDULE**

**SYLLABUS FOR THE EXAMINATION FOR A CERTIFICATE OF  
COMPETENCY AS AN ENGINEERING DECK RATING**

**SECTION A— SHIPBOARD SAFETY (GENERAL)**

1. Use of Life-Saving Appliances.
2. Pyrotechnic distress signals.
3. Shipboard emergency signals and duties.
4. Use of internal communications and alarm systems.
5. Basic first aid.
6. Use of fire fighting appliances.

**SECTION B—PERSONAL SAFETY AND SURVIVAL**

7. Safe working practices.
8. Cleanliness and hygiene.
9. Basic sea survival.

**SECTION C—NAUTICAL KNOWLEDGE**

10. The meaning of common ship-board, nautical and engineering terms.
11. The names and functions of various parts of the ship, for example, deck compartments, bulkheads, ballast tanks, bilges, strum boxes, sounding pipes, air pipes.
12. Knowledge of the layout of the deck and associated machinery.
13. Knowledge of the layout of the bridge and associated equipment and instruments.
14. Knowledge related to hygienic practices on board vessel.

UNOFFICIAL VERSION

UPDATED TO 31ST DECEMBER 2016

15. Ability to understand orders and make himself understood in matters relevant to the engine room ratings duties.

SECTION D— POLLUTION PREVENTION

16. Basic knowledge of duties and responsibilities regarding prevention of pollution of the seas and harbours.

SECTION E— PRACTICAL WORK

17. Dismantling and examination of the following:

- (a) non-return valves;
- (b) screw lift valves;
- (c) safety shut-off valves;
- (d) boiler down valves;
- (e) blow down valves;
- (f) boiler stop valves; and
- (g) feed check valves.

18. Dismantling and examination of the following:

- (a) strum boxes;
- (b) heat exchangers;
- (c) filters;
- (d) salinometer cocks;
- (e) boiler water level gauges;
- (f) pressure gauges;
- (g) tank level gauges; and
- (h) other types of gauges.

19. Starting and stopping pumps generally, air compressors, refrigeration machinery and maintenance of centrifuges.

20. Examination of electric switchboard instrumentation, circuit breakers and fuses.

21. Preparation of simple cable connections.

## SECTION F—ENGINEERING KNOWLEDGE AND ASSOCIATED STUDIES INCLUDING WATCH-KEEPING DUTIES, SIMPLE MECHANICAL AND ELECTRICAL SYSTEMS

22. Knowledge of engine room watchkeeping procedures and the ability to carry out a routine watch appropriate to his duties including, monitoring and recording relevant temperatures and pressures.
23. Knowledge of the appropriate action to be taken when temperatures and/or pressures deviate greatly from the norm in main machinery.
24. The use of the engine room log.
25. Knowledge of terms used in machinery spaces and names of machinery and equipment relative to his duties.
26. Knowledge of simple mechanical and related systems including bilge, pumping systems, ballast systems and the cofferdam.
27. Knowledge of routine maintenance by inspection, checks and cleaning of the following systems:
  - (a) lubricating oil and filtration;
  - (b) fuel oil and filtration; and
  - (c) diesel engine cooling.
28. Knowledge of compressed air starting systems and related systems.
29. Knowledge of the rudder arrangement and link with the steering gear system.
30. Knowledge of a typical shafting arrangement including the stern tube, tunnel bearings, thrust block and engine, etc.
31. Knowledge of safety procedure including—
  - (a) use of the appropriate internal communication systems;
  - (b) escape routes from machinery spaces;
  - (c) engine room alarm systems and ability to distinguish between the various alarms with special reference to fire extinguishing gas alarms;
  - (d) familiarity with the location and use of fire fighting equipment in the machinery spaces; and
  - (e) dangers and precautions to be taken to avoid electric shock on a.c. and d.c. supplies.

FOURTH SCHEDULE

Regulation 9(1).

REPUBLIC OF TRINIDAD AND TOBAGO

FORM OF APPLICATION FOR EXAMINATION FOR A CERTIFICATE OF  
COMPETENCY AS AN ENGINEERING RATING

(Application should be made to the Maritime Services Division at least three weeks before  
the examination date).

SECTION A—PARTICULARS OF APPLICANT

Name in full: Surname..... Other names.....

Address.....

Discharge Date and Place  
Book No..... of Birth.....

Rank/Rating.....

Nationality.....

Other Marine Qualifications held  
(if any)

.....  
.....  
.....  
.....  
.....

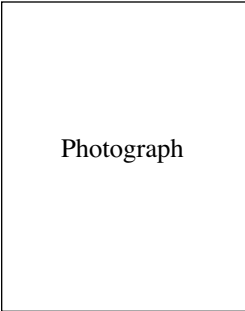

LAWS OF TRINIDAD AND TOBAGO

MINISTRY OF THE ATTORNEY GENERAL AND LEGAL AFFAIRS

www.legalaffairs.gov.tt

692

Chap. 50:10

Shipping

[Subsidiary]

Shipping (Certification of Seamen) (Engineering Ratings) Regulations

SECTION B—PREVIOUS CERTIFICATES

Have you attempted this examination before?

Yes  No  If yes, give date .....

Notes to applicant

- 1. If "Yes" complete only sections A, B and E in full and—
(a) complete section C regarding medical fitness certificate and, where applicable, an Engine Room Watch Rating Endorsement;
(b) show in section D only the sea service completed since your previous attempt.
2. If "No" then sections A, B, C, D and E must be completed.
3. In all cases the appropriate fee must be paid and a valid medical fitness certificate produced.

SECTION C—SUPPORTING DOCUMENTS

The following documents are submitted with this application:

(Official use only)
Examiner's Remarks

- 1. Certificate of attendance at a basic sea survival course
2. Birth Certificate or other proof of age
3. Passport or other proof of nationality
4. Medical fitness certificate
5. Certificate of attendance at an approved maritime safety training course (Applicable only where remission of sea service is being claimed)
6. Discharge book, certificates of discharge or other documentary evidence of sea service
7. Engine Room Watch Rating Endorsement
8. Two passport size photographs

UNOFFICIAL VERSION

UPDATED TO 31ST DECEMBER 2016



**LAWS OF TRINIDAD AND TOBAGO**

MINISTRY OF THE ATTORNEY GENERAL AND LEGAL AFFAIRS

www.legalaffairs.gov.tt

694

**Chap. 50:10**

*Shipping*

**[Subsidiary]**

*Shipping (Certification of Seamen) (Engineering Ratings) Regulations*

**SECTION E—DECLARATION OF APPLICANTS**

[Any person making a false declaration is guilty of an offence and is liable to a fine and imprisonment under the Shipping Act (Ch. 50:10)].

DECLARATION: I hereby declare that the information given in this application is to the best of my knowledge, true and complete.

Signature of Applicant .....

Date .....

---

---

**The following sections are for official use only**

**SECTION F—FEES**

I hereby certify that the examination fee of \$ ..... has been received.



Signature .....

Title .....

*Cashier, etc.*

Date .....

Maritime Services Division

---

---

UNOFFICIAL VERSION

UPDATED TO 31ST DECEMBER 2016

SECTION G—SUMMARY AND EVALUATION OF SEA SERVICE

The sea service, based on the statement of service given in section D, with supporting documents, is as follows:

Total qualifying sea service in major ships [(Reg. 10(2))] .....

Total qualifying sea service in minor ship [(Reg. 10 (3)(a))] .....

Reduction of sea service (Reg. 11) .....

Remarks:

---



Signed ..... Examiner

Name .....

Date .....

Maritime Services Division

SECTION H—RESULT OF EXAMINATION

I have today examined ..... for the Certificate of Competency  
*(Name of Candidate)*  
as an Engineering Rating, with the following result: PASS/FAIL

The Certificate, when issued, should bear the following endorsement:

Endorsement:

---



Signed ..... Examiner

Name .....

Date .....

(Exn. 2) (1995)

Maritime Services Division

**LAWS OF TRINIDAD AND TOBAGO**

MINISTRY OF THE ATTORNEY GENERAL AND LEGAL AFFAIRS

www.legalaffairs.gov.tt

696

**Chap. 50:10**

*Shipping*

**[Subsidiary]**

*Shipping (Certification of Seamen) (Engineering Ratings) Regulations*

**SECTION I—AUTHORITY TO ISSUE CERTIFICATE**

(To be completed by the Examiner, detached and given to successful candidate)

This is to certify that ..... passed the examination for  
*(Name of Candidate)*

the Certificate of Competency as an Engineer Rating held on ..... and may be issued with the Certificate as an Engineering Rating Category 1 \*/Engineering Rating Category 2.

\*Delete whichever is inapplicable.

The Certificate when issued, should bear the following endorsement.

Endorsement:



Signature of Examiner .....

Name of Examiner .....

Date .....

Maritime Services Division

NOTE to Candidate:

To obtain your Certificate of Competency as an Engineering Rating, this authority, together with proof of identity and the appropriate fee for the issue of the Certificate, should be produced to the office of the Maritime Services Division.

Signed ..... (Candidate)

Date .....  
(Exn. 20) (1995)

\_\_\_\_\_

UNOFFICIAL VERSION

UPDATED TO 31ST DECEMBER 2016

**FIFTH SCHEDULE**

Regulation 14.

**FORM OF APPLICATION FOR A CERTIFICATE OF COMPETENCY OR  
CLASSIFICATION AS AN ENGINEERING RATING**

(Application should be made to the Maritime Services Division)

---

---

SECTION A—PARTICULARS OF APPLICANT

Name in full: Surname..... Other names.....

Address.....

Discharge Date and Place  
Book No. .... of Birth.....

Rank/Rating.....

Nationality.....

Other Marine Qualifications held  
(if any)

.....  
.....  
.....  
.....  
.....

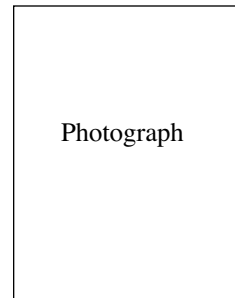

LAWS OF TRINIDAD AND TOBAGO

MINISTRY OF THE ATTORNEY GENERAL AND LEGAL AFFAIRS

www.legalaffairs.gov.tt

698

Chap. 50:10

Shipping

[Subsidiary]

Shipping (Certification of Seamen) (Engineering Ratings) Regulations

SECTION B—PREVIOUS CERTIFICATES

Have you previously been issued with an Engineering Rating Category 2 Certificate

Yes

No

If yes, give date of issue .....

Notes to applicant

- 1. If "Yes" complete only sections A, B and E in full and— (a) complete section C regarding medical fitness certificate; engine room watch rating endorsement and rating nominated as assistant to the engineer officer in charge of the watch endorsement. (b) show in section D only the sea service completed since being issued with a certificate engineering rating category 2.

2. If "No" then section A, B, C, D and E must be completed.

3. In all cases the appropriate fee must be paid and a valid medical fitness certificate produced.

SECTION C—SUPPORTING DOCUMENTS

The following documents are submitted with this application:

(Official use only) Remarks

- 1. Certificate of attendance at a basic sea survival course
- 2. Birth Certificate or other proof of age
- 3. Passport or other proof of nationality
- 4. Medical fitness certificate
- 5. Certificate of attendance at an approved maritime safety training course (Applicable only where remission of sea service is being claimed)
- 6. Discharge book, certificates of discharge or other documentary evidence of sea service
- 7. Engine room watch rating endorsement
- 8. Two passport size photographs
- 9. Rating nominated as assistant to the engineer officer in charge of the watch

UNOFFICIAL VERSION

UPDATED TO 31ST DECEMBER 2016



**LAWS OF TRINIDAD AND TOBAGO**

MINISTRY OF THE ATTORNEY GENERAL AND LEGAL AFFAIRS

www.legalaffairs.gov.tt

700

**Chap. 50:10**

*Shipping*

**[Subsidiary]**

*Shipping (Certification of Seamen) (Engineering Ratings) Regulations*

**SECTION E—DECLARATION OF APPLICANT**

(Any person making a false declaration is guilty of an offence and is liable to a fine and imprisonment under the Shipping Act, (Ch. 50:10).

DECLARATION: I hereby declare that the information given in this application is to the best of my knowledge true and complete.

Signature of Applicant .....

Date .....

---

---

**The following sections are for official use only**

**SECTION F—SUMMARY AND EVALUATION OF SEA SERVICE**

The sea service, based on the statement of service given in section D, with supporting documents, is as follows:

Total qualifying sea service in major ships [Reg. 10(2)] .....

Total qualifying sea service in minor ships [Reg. 10 (3)(a)] .....

Reduction of sea service (Reg. 11) .....

Other service (e.g., Gulf of Paria service) .....

---

Remarks:



Maritime Services Division

UNOFFICIAL VERSION

UPDATED TO 31ST DECEMBER 2016

SECTION G—AUTHORITY TO ISSUE CERTIFICATE

Signed .....

Name .....

Date .....

This is to certify that ..... may be issued with  
(Name of applicant)

\*a Certificate of Classification as an Engineering Rating Category 4

\*a Certificate of Classification as an Engineering Rating Category 3

\*a Certificate of Competency as an Engineering Rating Category 1

The Certificate when issued, should bear the following endorsement:.

Endorsement:



Maritime Services Division

Signature of Examiner .....

Name of Examiner .....

Date.....

\*delete whichever is inapplicable.

\_\_\_\_\_

**LAWS OF TRINIDAD AND TOBAGO**

MINISTRY OF THE ATTORNEY GENERAL AND LEGAL AFFAIRS

www.legalaffairs.gov.tt

702

**Chap. 50:10**

*Shipping*

**[Subsidiary]**

*Shipping (Certification of Seamen) (Engineering Ratings) Regulations*

**SIXTH SCHEDULE**

Regulation 15.

**FEES**

<i>Service</i>	<i>Fees</i> \$
1. For the examination for a certificate of competency as an Engineering Rating	60.00
2. For the issue of—	
(a) a Certificate of Competency	40.00
(b) a Certificate of Classification	40.00
3. For the replacement of a certificate which has been lost or of an unendorsed certificate by one which is endorsed	40.00

---

UNOFFICIAL VERSION

UPDATED TO 31ST DECEMBER 2016

**SHIPPING (CREW ACCOMMODATION)  
REGULATIONS**

ARRANGEMENT OF REGULATIONS

REGULATION

1. Citation.

**PART I**

**REQUIREMENTS TO BE COMPLIED WITH BY SHIPS  
REGISTERED IN TRINIDAD AND TOBAGO ON OR  
AFTER THE DATE ON WHICH THESE REGULATIONS  
COME INTO OPERATION**

2. Interpretation.
3. Application.
4. Extension to unregistered Trinidad and Tobago ships.
5. Plans.
6. General.
7. Divisions between the crew accommodation and other parts of the ship.
8. Interior bulkheads.
9. Overhead decks.
10. Floor decks.
11. Access and escape arrangements.
12. Pipes, etc.
13. Awnings.
14. Heating.
15. Lighting.
16. Ventilation.
17. Sidescuttles and windows.
18. Drainage.
19. Interior finishes.
20. Marking.
21. Sleeping Rooms.
22. Beds.
23. Furniture and fittings in sleeping rooms.
24. Mess rooms.
25. Furniture and fittings in mess room.

**LAWS OF TRINIDAD AND TOBAGO**

MINISTRY OF THE ATTORNEY GENERAL AND LEGAL AFFAIRS

www.legalaffairs.gov.tt

704

**Chap. 50:10**

*Shipping*

[Subsidiary]

*Shipping (Crew Accommodation) Regulations*

ARRANGEMENT OF REGULATIONS—*Continued*

**REGULATION**

26. Recreation spaces.
27. Offices.
28. Sanitary accommodation.
29. Supply of drinking water.
30. Supply of fresh water.
31. Facilities for washing and drying clothes and for hanging oilskins and working clothes.
32. Galleys.
33. Dry provision storerooms.
34. Cold storerooms and refrigerating equipment.
35. Hospitals.
36. Medical cabinet.
37. Protection from mosquitoes.
38. Maintenance and inspection of crew accommodation.

**PART II**

**REQUIREMENTS TO BE COMPLIED WITH BY SHIPS REGISTERED IN TRINIDAD AND TOBAGO BEFORE THE DATE ON WHICH THESE REGULATIONS COME INTO OPERATION**

39. Interpretation.
40. Application.
41. Exemptions.
42. Duration of exemption.

**FIRST SCHEDULE.**

**SECOND SCHEDULE.**

**THIRD SCHEDULE.**

**FOURTH SCHEDULE.**

**FIFTH SCHEDULE.**

**SIXTH SCHEDULE.**

---

UNOFFICIAL VERSION

UPDATED TO 31ST DECEMBER 2016

**SHIPPING (CREW ACCOMMODATION)  
REGULATIONS**

94/1996.

*made under section 147*

1. These Regulations may be cited as the Shipping (Crew Accommodation) Regulations. Citation.

**PART I**

**REQUIREMENTS TO BE COMPLIED WITH BY SHIPS  
REGISTERED IN TRINIDAD AND TOBAGO ON OR  
AFTER THE DATE ON WHICH THESE REGULATIONS  
COME INTO OPERATION**

2. In this Part—

Interpretation.

“Act” means the Shipping Act;

“Caribbean trade ship” includes every ship employed in trading within the Caribbean Trading Area;

“Caribbean Trading Area” means an Area bounded by a line from a point on the East coast of the United States of America in latitude 35°00' North, to a point 5°00' South, 33°00' West; thence to a point 10°00' South, 33°00' West; thence to a point on the coast of Brazil in latitude 10°00' South; thence northward along the coast of Continental America to a point in latitude 35°00' North, on the East coast of the United States of America;

“controlled drugs” are preparations subject to the prescription requirements of any misuse of Drugs Regulations made under the Act;

“fishing vessel” includes a fishery research vessel but does not include a fishery protection vessel;

“Minister” means the Minister to whom the responsibility for shipping is assigned;

“passenger” does not include the spouse or child of a member of the crew travelling with him;

“passenger ship” means a ship carrying more than twelve passengers;

“private bathroom” means a bathroom provided for the exclusive use of one person;

“semi-private bathroom” means a bathroom provided for the exclusive use of two persons;

“suitable”, in relation to material, means approved by the Minister as suitable for the purpose for which it is used;

“surveyor of ships” means a person appointed as a surveyor under the Act;

“tons” means gross tons and the gross tonnage of a ship having alternative gross tonnages shall be taken to be the larger of those tonnages;

“unlimited trade ship” includes every ship employed in trading or going between some place or places in Trinidad and Tobago and some place or places situated beyond the limits of the Caribbean Trading Area.

Application.  
First and  
Fifth Schedules.

**3.** (1) Subject to regulation 4, this Part and the First and Fifth Schedules inclusive shall apply to—

(a) every ship registered outside Trinidad and Tobago the keel of which is laid or which is at a similar stage of construction on or after the date on which these regulations come into operation;

(b) any ship registered outside Trinidad and Tobago before the date on which these Regulations come into operation which is re-registered in Trinidad and Tobago on or after that date; and

(c) every ship to which regulation 40 would otherwise apply, but which has been reconstructed or substantially altered.

(2) This Part and the First to Fifth Schedules shall not apply to—

(a) a ship to which Part II applies;

(b) fishing vessels;

(c) vessels primarily used for sport or recreation; and

(d) Government ships operated for non-commercial purposes.

**4.** (1) Section 147 of the Act and this Part shall apply to every Trinidad and Tobago ship which is not registered in Trinidad and Tobago or elsewhere of the following description, that is to say, every ship which—

Extension to unregistered Trinidad and Tobago ships.

- (a) is wholly owned by a person resident in or by a body corporate having its principal place of business in Trinidad and Tobago; and
- (b) is required to be registered under the Act but is not so registered in Trinidad and Tobago or elsewhere,

and to masters and seamen employed in her.

(2) This Part shall apply to every such unregistered ship as and to the extent that they would apply to her if she were a ship which had been registered for the first time under Part III of the Act, on the date on which her construction was completed and regulation 3 shall be construed accordingly.

**5.** (1) Every person to whose order a ship to which this Part applies is being constructed shall submit the following plans to a surveyor of ships:

Plans.

- (a) before construction is begun, a plan of the ship on a scale not smaller than—
  - (i) 1 in 100 in the case of a ship of less than 150 metres in length; and
  - (ii) 1 in 200 in the case of any other ship showing clearly the proposed arrangements of the crew accommodation in the ship and its proposed position in relation to the ship's other spaces;
- (b) before construction of any part of the crew accommodation is begun—
  - (i) plans of the proposed crew accommodation on a scale not smaller than 1 in 50 showing clearly and in detail the purpose for which each space in the crew accommodation is to be appropriated and the proposed disposition of the furnishings, fittings and obstructions in it; and

LAWS OF TRINIDAD AND TOBAGO

MINISTRY OF THE ATTORNEY GENERAL AND LEGAL AFFAIRS

www.legalaffairs.gov.tt

708

Chap. 50:10

Shipping

[Subsidiary]

Shipping (Crew Accommodation) Regulations

- (ii) plans showing clearly the proposed arrangements for supplying water to the crew accommodation, for covering the floors, and for heating, lighting, ventilating, insulating and draining the crew accommodation.

(2) The owner of every ship to which this Part applies shall, before any reconstruction or alteration of the ship's crew accommodation is carried out, submit to a surveyor of ships the plans specified in subregulation (1) relating to the crew accommodation as reconstructed or altered as the case may be.

(3) Where the crew accommodation is reconstructed or altered at a place outside Trinidad and Tobago in consequence of any emergency or any accident to the ship, such plans shall be submitted to a surveyor of ships as soon as practicable.

General.

**6.** (1) All parts of the crew accommodation except store rooms shall—

- (a) wherever practicable be situated amidships or aft;
- (b) in no case shall any part of the crew accommodation, except a storeroom, be situated forward of the collision bulkhead; and
- (c) be situated wholly above the Summer Load Line, if any, marked on the ship in accordance with the provisions of regulations made under section 280 of the Act.

(2) The crew accommodation shall be so situated, constructed and arranged as to exclude as far as is reasonably practicable—

- (a) from the crew accommodation, noise coming from other parts of the ship; and
- (b) from any part of the crew accommodation, noise coming from other parts of it.

(3) Sleeping rooms forming part of the crew accommodation of a passenger ship shall not be situated immediately beneath a working passageway.

UNOFFICIAL VERSION

UPDATED TO 31ST DECEMBER 2016

(4) In every ship any bulkhead, casing or deck separating a sleeping room from—

- (a) a machinery space;
- (b) a mess room;
- (c) a recreation room;
- (d) a room in which films or television are shown;
- (e) a games room; or
- (f) a public room,

shall be acoustically insulated in a way which will prevent the occupants of that sleeping room from being disturbed by excessive noise from that space or room.

(5) In the crew accommodation—

- (a) all structures, furniture and fittings, and the means of access to and egress from the crew accommodation, shall be so situated, constructed and arranged as to minimise any risk of injury to the crew;
- (b) to afford protection to the crew in rough sea conditions—
  - (i) handrails shall be provided in passageways and stairways where necessary and shall be of robust construction and strongly secured to bulkheads;
  - (ii) fixed furniture shall be strongly secured;
  - (iii) means shall be provided to secure portable furniture;
  - (iv) doors, including those to cupboards and other items of furniture shall be so secured as not to open accidentally;
  - (v) drawers shall be so designed as not to slide open and fall out accidentally; and
  - (vi) tables, shelves, stowage racks and other similar fittings shall be fitted with retaining lips or bars or with non-slip surfaces so that objects placed on them will not slide off.

**LAWS OF TRINIDAD AND TOBAGO**

MINISTRY OF THE ATTORNEY GENERAL AND LEGAL AFFAIRS

www.legalaffairs.gov.tt

710

**Chap. 50:10**

*Shipping*

**[Subsidiary]**

*Shipping (Crew Accommodation) Regulations*

(6) All parts of the crew accommodation, except cold storerooms, shall have a clear headroom of at least 1.98 metres at every point where full and free movement is necessary.

(7) The Minister may permit reduction in headroom in any space or part of any space, in such accommodation where he is satisfied that it is reasonable so to do and also that such reduction will not result in discomfort to the crew.

(8) Subject to regulation 35(30), no part of the accommodation provided pursuant to this Part shall be shared with passengers or used by or for the benefit of passengers.

(9) Where oil or gaseous fuel is used in any ship, the arrangements for its storage, distribution and utilisation shall be such as to minimise the risk of fire or explosion within the crew accommodation which the use of that fuel may entail.

(10) Inside panelling in the crew accommodation shall be constructed of a suitable material.

(11) The crew accommodation shall be so situated, constructed and arranged as to ensure the exclusion from the crew accommodation of effluvia originating in other spaces in the ship.

Divisions  
between the  
crew  
accommodation  
and other parts  
of the ship.

**7. (1)** Bulkheads which enclose any part of the crew accommodation and are exposed to the weather shall be properly constructed of steel or other suitable material, and shall be of watertight construction.

(2) Any openings in them shall be provided with means of weathertight closure.

(3) The means of weathertight closure provided for any entrance shall be a hinged door.

(4) Bulkheads which enclose any part of the crew accommodation and are exposed to the weather, and any parts of the sides of the ship which form walls of the crew accommodation, shall be so insulated as to prevent overheating or condensation unless the crew accommodation is so protected by its situation and ventilation that overheating and condensation are unlikely to occur.

UNOFFICIAL VERSION

UPDATED TO 31ST DECEMBER 2016

(5) Every bulkhead, casing or deck separating any part of the crew accommodation from any space including a cold storeroom, which is subject to abnormal heat or cold shall be so insulated as to prevent condensation or discomfort to the crew.

(6) Every bulkhead which separates any part of the crew accommodation, other than recreation deck space from a space used as—

- (a) a machinery space;
- (b) a bunker;
- (c) a room for storing fire-extinguishing gases;
- (d) a chain locker;
- (e) a cofferdam;
- (f) a cargo space;
- (g) a store room;
- (h) a lamp room or paint room; and
- (i) a battery locker,

shall be of gastight construction, and shall be of watertight construction where necessary to protect the crew accommodation.

(7) There shall be no opening in any of the bulkheads referred to in subregulation (6) subject to the following:

- (a) where sanitary accommodation or changing rooms provided for the exclusive use of engine room officers and ratings are sited adjacent to the propelling machinery space there may be an opening in the propelling machinery space bulkhead to the sanitary accommodation or changing rooms and an opening from the sanitary accommodation or changing rooms to a passageway forming part of the crew accommodation if a hinged, steel, self-closing gastight door is fitted to one of such openings;
- (b) where no other arrangement is practicable, there may be an opening in a bulkhead separating a passageway in the crew accommodation from a machinery space if that opening is provided with a hinged, steel, self-closing gastight door;

- (c) in ships of under 500 tons there may, where no other arrangement is practicable, be an opening in a bulkhead separating a passageway in the crew accommodation from an engine or deck storeroom if that opening is provided with a hinged, steel, self-closing gastight door; and
- (d) where no other arrangement is practicable, there may be an opening in a bulkhead separating a passageway in the crew accommodation from any of the spaces specified in subregulation (6)(d) and (e) or from a storeroom other than an engine or deck storeroom if that opening is sealed in a way which is effective having regard to the use of the space.

(8) No batteries of a type which emit gases shall be stored in the crew accommodation and there shall be no opening from the crew accommodation into a space where such batteries are stored.

(9) Precautions shall be taken to ensure that fumes from batteries cannot be discharged into the crew accommodation.

(10) Any part of the crew accommodation which adjoins a tank in which oil may be carried shall be separated from that tank either—

- (a) by a gastight steel division additional to the division which retains the oil; or
- (b) by a division of all-welded steel construction capable of withstanding a head of water at least 1.52 metres greater than the maximum service head.

(11) No manhole or other opening to a fuel tank shall be situated in the crew accommodation.

Interior  
bulkheads.

**8. (1)** All bulkheads within the crew accommodation shall be properly constructed of steel or other suitable material.

(2) Subject to subregulation (3)—

(a) every bulkhead which separates any part of the crew accommodation from—

- (i) sanitary accommodation;
- (ii) a laundry;
- (iii) a drying room;
- (iv) a galley;
- (v) a cold store room; or
- (vi) a dry provision store room,

shall be of gastight construction;

(b) every bulkhead which separates any part of the crew accommodation from any of the spaces specified in paragraph (a)(i) to (v) inclusive above shall be watertight to a height of not less than 230 millimetres, except in the case of doorways situated in bulkheads when the bulkheads shall be watertight to a height of not less than 100 millimetres.

(3) The requirements of subregulation (2) shall not apply to bulkheads separating—

- (a) a space appropriated for a particular use from another space appropriated for the same use;
- (b) a laundry from a drying room;
- (c) a private bathroom from the sleeping room of the person for whose use it is provided if there is direct access from the sleeping room to the private bathroom.

(4) Subject to the provisions of regulation 28(13) there shall be no openings in any bulkhead separating any sanitary accommodation, laundry or drying room from any part of the crew accommodation except a passageway, recreation deck space or other sanitary accommodation, laundry or drying room nor in a bulkhead separating a galley from a sleeping room.

LAWS OF TRINIDAD AND TOBAGO

MINISTRY OF THE ATTORNEY GENERAL AND LEGAL AFFAIRS

www.legalaffairs.gov.tt

714

Chap. 50:10

Shipping

[Subsidiary]

Shipping (Crew Accommodation) Regulations

Overhead decks. **9.** (1) In every ship of which the hull is constructed of metal every deck which forms the crown of any part of the crew accommodation (in this regulation called an “overhead deck”), and which is exposed to the weather shall be made of metal and shall either—

(a) be covered on its upper side with—

(i) wood not less than 57 millimetres thick, properly laid and caulked; or

First Schedule.

(ii) a material complying with the requirements specified in the First Schedule and properly laid; or

(b) be insulated on its underside with a material complying with the requirements specified in the Second Schedule.

Second Schedule.

(2) In every ship of which the hull is not constructed of metal the overhead decks shall be constructed of wood not less than 63 millimetres thick properly laid and caulked or of other suitable material having properties of watertightness and insulation equivalent to such a wooden deck.

Floor decks.

**10.** (1) Every deck which forms the floor of any part of the crew accommodation (in this regulation called a “floor deck”) shall be properly constructed.

(2) Where the floor deck is directly over an oil tank or permanent coal bunker, it shall be oil tight or gastight respectively.

(3) Every floor deck shall have a surface which provides a good foothold and can be easily kept clean.

(4) Any floor covering shall be impervious to water and, where the deck is directly over an oil tank, impervious to oil.

(5) Every floor deck made of wood shall be at least 63 millimetres thick and shall be properly laid and caulked.

First Schedule.

(6) Subject to subregulation (4), every floor deck made of metal, except floor decks in sanitary accommodation, galleys, laundries and storerooms, shall be covered with a material which complies with the requirements specified in the First Schedule.

UNOFFICIAL VERSION

UPDATED TO 31ST DECEMBER 2016

(7) The material of every floor deck shall be properly laid and the joins where the floor meets the walls shall be rounded in such a way as to avoid crevices.

(8) On every floor deck in crew accommodation, where a fitted carpet is laid such carpet shall be laid on a deck covering complying with the requirements of the First Schedule and shall be such that it will not readily ignite.

(9) Every floor deck in sanitary accommodation, galleys and laundries shall be covered with terrazzo tiles or other hard material which is impervious to liquids and provides a good foothold.

(10) The covering shall be properly laid and the joins where the floor meets the walls shall be rounded in such a way as to avoid crevices.

**11.** (1) Every entrance into the crew accommodation from the open deck shall be so situated and constructed as to be protected against the weather and sea to the greatest extent practicable.

Access and  
escape  
arrangements.

(2) The entrances shall be so situated that the crew accommodation is accessible, at all times and in all weathers.

(3) At least one means of access, either direct or via not more than two rooms forming part of a suite, to any sleeping room, day room, mess room, recreation room, study, office, sanitary accommodation or galley, shall be from an enclosed passageway.

(4) Two entirely separate escape routes shall be provided for each compartment, each route leading from the compartment to a suitably sited opening which may be a normally used entrance, on to a weather deck.

(5) The escape routes, which shall not pass through propelling machinery spaces, galleys or other spaces where the risk or injury from fire, steam or other similar cause is comparatively high, shall be so arranged as to provide a ready and unimpeded means of escape from each compartment to the ship's boats, lifeboats or liferafts.

(6) Where escape routes are by way of stairways or ladderways, those stairways or ladderways shall be constructed of steel.

(7) In subregulation (4) “compartment” means all living and working spaces within the watertight or fire-resisting boundaries on any one level which are served by inter-communicating passageways.

Pipes, etc.

**12.** (1) Except where no other arrangement is reasonably practicable, steam supply and exhaust pipes for steering gear, winches and similar equipment shall not pass through the crew accommodation.

(2) Where any such pipes do pass through the crew accommodation they shall pass through passageways only, shall be properly encased, and in the case of supply pipes—

- (a) shall be constructed of solid drawn steel or other suitable material;
- (b) shall be of a scantling sufficient to withstand the maximum pressure from the ship’s boiler system;
- (c) shall have all connections made by faced flanges properly jointed; and
- (d) shall be fitted with adequate drainage arrangements.

(3) Steam pipes, hot water pipes and calorifiers in the crew accommodation shall be efficiently lagged wherever necessary for the protection of the crew against injury or discomfort.

(4) Cold water pipes in the crew accommodation shall be lagged where necessary for the prevention of condensation.

(5) Where any parts of chain pipes and ventilator trunks to cargo spaces or tanks pass through the crew accommodation, they shall be made of steel or other suitable material and be gastight.

(6) Pipes used for crew accommodation services shall be of adequate dimension having regard to their particular purpose and, in addition, soil pipes and waste pipes shall be so constructed as to minimise the risk of obstruction and to facilitate cleaning.

(7) Soil pipes shall not pass overhead in mess rooms, sleeping rooms, dry provision storerooms, galleys or the hospital, except where it is impracticable to place them elsewhere.

(8) No soil or waste-pipe shall pass through drinking water tanks or other fresh water tanks.

(9) Hawse pipes shall not pass through the crew accommodation.

**13.** Every ship for the time being regularly engaged on voyages to or within the Tropics or the Persian Gulf shall be provided with— Awnings.

- (a) awnings suitable to cover such area of any deck space provided pursuant to regulation 26(5) for the recreation of the crew as well, when covered with the awnings, provide a shaded area of adequate extent having regard to the number of persons in the crew and to any shade provided on that deck space by overhanging decks; and
- (b) stanchions or other suitable supports for those awnings.

**14.** (1) Except in ships employed solely within the Tropics or the Persian Gulf, all sleeping rooms, mess rooms, day rooms, recreation rooms, rooms for sanitary accommodation and hospitals shall be provided with a permanently installed heating system, in this regulation called “the main heating system”, capable of ensuring that when— Heating.

- (a) the ventilation system provided for the room or accommodation is working so as to supply at least 25 cubic metres of fresh air per hour for each person whom the room or accommodation is designed to accommodate at any one time; and
- (b) the temperature of the ambient air is—1°C,

the temperature in that room or accommodation can be maintained at 21°C.

LAWS OF TRINIDAD AND TOBAGO

MINISTRY OF THE ATTORNEY GENERAL AND LEGAL AFFAIRS

www.legalaffairs.gov.tt

718

Chap. 50:10

Shipping

[Subsidiary]

Shipping (Crew Accommodation) Regulations

(2) The main heating system shall be operated by steam, hot water, or electricity, or shall be a system supplying warm air.

(3) Means of turning on or off or varying the heat emitted by a radiator or other heating device without using a tool or key shall, wherever reasonably practicable, be provided in the space in which that radiator or other device is fitted.

(4) All heating equipment shall be so constructed that its operation is not affected by the use or non-use of propelling machinery, steering gear, deck machinery calorifiers or cooking appliances.

(5) Heating by means of the main heating system need not be provided when the vessel is in port if such parts of the crew accommodation as are then in use are provided with a safe and efficient temporary means of heating capable of ensuring the standard required by subregulation (1).

(6) Heating equipment shall be so constructed and installed, and if necessary shielded, as to avoid risk of fire or of danger or discomfort to the crew.

Lighting.

**15.** (1) In passenger ships all parts of the crew accommodation, except galleys, pantries, laundries, drying rooms, lockers, private and semi-private bathrooms and storerooms, shall wherever reasonably practicable be adequately lit by natural light.

(2) In ships other than passenger ships all parts of the crew accommodation, except galleys, pantries, laundries, drying rooms, lockers, private and semi-private bathrooms and storerooms, shall be adequately lit by natural light.

(3) Sanitary accommodation and passageways shall wherever reasonably practicable be adequately lit by natural light.

(4) For the purposes of subregulations (1), (2) and (3), “adequately lit” means lit by natural light which is bright enough in daytime in clear weather to enable a person with normal sight to read an ordinary newspaper in those parts of the room or other space which are available for free movement.

UNOFFICIAL VERSION

UPDATED TO 31ST DECEMBER 2016

(5) An electric lighting system shall be installed which is capable of supplying adequate light in all parts of the crew accommodation.

(6) Electric lights shall be so arranged as to give maximum benefit to the crew and shall include an electric reading lamp for each bed, fitted with a controlling switch at the head of the bed.

(7) An efficient alternative lighting system or an alternative supply of electrical power to the system mentioned in subregulation (5) shall be available for use when required in the crew accommodation.

(8) Any reading light provided in accordance with subregulation (5) shall—

- (a) in a sleeping room be fitted with a lamp capable of emitting at least 200 lumens; and
- (b) in a hospital ward be fitted with a lamp capable of emitting at least 400 lumens.

(9) The electric lighting in any of the following spaces:

- (a) sleeping rooms;
- (b) day rooms;
- (c) recreation rooms;
- (d) rooms for watching films and television;
- (e) hobbies and games rooms;
- (f) mess rooms;
- (g) hospital wards;
- (h) offices;
- (i) studies;
- (j) sanitary accommodation;
- (k) laundries;
- (l) drying rooms;
- (m) drying provision storerooms;
- (n) cold storerooms;
- (o) galleys;
- (p) passageways;
- (q) companionways; and
- (r) covered deck recreation spaces,

LAWS OF TRINIDAD AND TOBAGO

MINISTRY OF THE ATTORNEY GENERAL AND LEGAL AFFAIRS

www.legalaffairs.gov.tt

720

Chap. 50:10

Shipping

[Subsidiary]

Shipping (Crew Accommodation) Regulations

shall be adequate for the purposes of this regulation if—

- (i) when the lamps, paintwork and other surface finishes are new, the illuminance in the horizontal plane when measured at the points specified in respect of that space in the Third Schedule is steady and is maintained, subject to a tolerance of 10 per cent, at the value prescribed in that Schedule in respect of those points; and
- (ii) it complies with any other requirements specified in the Third Schedule in respect of that space.

Third  
Schedule.

Ventilation.

**16.** (1) Every enclosed space in the crew accommodation, except a cold storeroom, shall be provided with a ventilation system capable of maintaining the air in that space in a sufficiently pure condition for the health and comfort of the crew in all conditions of weather and climate which the ship is likely to encounter during the voyages on which she is intended to be engaged, and capable of being controlled as necessary for that purpose.

(2) The ventilation system shall be additional to any sidescuttles, skylights, companionways, doors or other openings not intended solely for ventilation, and shall be so arranged as to keep noise levels to a minimum and not to cause undue vibration.

(3) Without prejudice to the generality of subregulations (1) and (2)—

- (a) in all unlimited trade ships of 1,000 tons or over except those regularly employed in latitudes north of latitude 50° North or South of latitude 45° South; and
- (b) in all ships of under 1,000 tons regularly engaged in voyages solely within the area of the Tropics or the Persian Gulf,

the ventilation system provided for every enclosed space in the crew accommodation except a cold storeroom or a galley shall be an airconditioning system, (in this Part called “an air-conditioning

UNOFFICIAL VERSION

UPDATED TO 31ST DECEMBER 2016

system” vc) complying with the following requirements:

- (i) it shall be of sufficient capacity to maintain a temperature of 29°C (dry bulb) and 50 per cent relative humidity when the ambient conditions are 32°C (dry bulb) and 78 per cent relative humidity;
- (ii) the minimum number of conditioned air changes shall be eight per hour in any mess room or recreation room and six per hour in any other space;
- (iii) when recirculation is employed, the minimum amount of fresh air supplied shall be 25 cubic metres per hour for each person for whom accommodation is provided, or the total capacity of the sanitary and any other accommodation exhaust fans excluding the galley, whichever is the greater; and
- (iv) the system shall have its own cooling machinery and shall not be connected to any refrigerating machinery provided in the ship for other purposes.

(4) In ships provided with an air-conditioning system, sanitary accommodation, laundries, drying rooms, changing rooms and pantries shall be provided with mechanical exhaust ventilation complying with the requirements specified in the Fourth Schedule.

Fourth  
Schedule.

(5) Without prejudice to the generality of subregulation (1), in all ships except those of under 500 tons which are regularly employed in latitudes North of latitude 50° North or South of latitude 45° South, every enclosed space in the crew accommodation, except a cold storeroom, shall, where it is not ventilated by an air-conditioning system, be provided with a trunked mechanical ventilation system, complying with the requirements of the Fourth Schedule.

(6) In ships regularly employed in latitudes North of latitude 50° North or South of latitude 45° South, the number of fresh air changes per hour specified in that Schedule may be reduced by one-third.

(7) A supply of power adequate to operate an air-conditioning system or trunked mechanical ventilation system shall be provided.

(8) Any such system fitted shall be in operation at all times when any members of the crew are on board and the circumstances are such that ventilation by means of such system is required.

(9) The spare gear specified in the Fourth Schedule shall be properly packed for storage and be carried for any air-conditioning system or trunked mechanical ventilation system fitted in compliance with this regulation.

(10) In every ship, every enclosed space in the crew accommodation which is not ventilated either by an air-conditioning system or by a trunked mechanical ventilation system shall be provided with a natural system or inlet and exhaust ventilation complying with the following requirement:

- (a) every inlet ventilator which is situated in the open air shall be of a cowl or other equally efficient type of ventilator and shall be so placed that, so far as is practicable, it is not screened from the wind in any direction;
- (b) no inlet ventilator shall be situated over a doorway, stairway or exhaust opening;
- (c) the sectional area of all parts of the inlet and exhaust system serving each space, except parts serving a drying room or locker only, shall be at least 0.012 square metres in all or at least 0.004 square metres per person for as many persons as are likely to use the space at any one time, whichever shall be the greater; and
- (d) the effective area of the inlet and exhaust system shall be adjustable from fully open down to a minimum area of 0.002 square metres per person for as many persons as are likely to use the space at any one time.

**17.** (1) Subject to subregulation (2), any sidescuttles for windows in a sleeping room, day room, mess room, recreation room or hospital ward without which the standard of lighting required for that room by regulation 15(1) or (2) would not be attained, shall—

Sidescuttles and windows.

- (a) unless the room is served by an air-conditioning system complying with regulation 16, be of the opening type;
- (b) where the room is served by such an air-conditioning system then only 50% of such sidescuttles or windows need be of the opening type.

(2) No sidescuttle or window shall be of the opening type, if it is required by any other regulations under the Act to be of the non-opening type.

(3) Where, by reason of the requirements of subregulation (2) it is not possible in respect of any room to comply fully with subregulation (1), then—

- (a) where that room is one in respect of which the requirements of regulation 16 as to the type of ventilation system to be provided would have been adequately fulfilled by the provision of a natural system of inlet and exhaust ventilation then, notwithstanding those requirements, that room shall be provided with a trunked mechanical ventilation system; and
- (b) where that room is one in respect of which the requirements of regulation 16 as to the type of ventilation system to be provided would have been adequately fulfilled by the provision of a trunked mechanical ventilation system then, notwithstanding those requirements, that room shall be provided with an air-conditioning system.

(4) In every ship of 3,000 tons or over every sidescuttle shall be at least 300 millimetres in diameter.

**18.** (1) The crew accommodation shall be efficiently drained.

Drainage.

(2) Drainage pipes and channels shall be provided wherever necessary to clear water shipped from the sea.

(3) In order to preclude effluvia from the crew accommodation, the soil and other waste water drainage system shall be so arranged and fitted with such water seals, air vents and storm valves as are necessary to prevent siphonage or blow-back.

(4) Each space in the sanitary accommodation, except private bathrooms, and each laundry shall be served by one or more scuppers which do not serve any space other than sanitary accommodation or another laundry.

(5) The scuppers shall be at least 50 millimetres in diameter, and shall be placed wherever water is likely to collect on the floor.

(6) There shall be no drainage into sanitary accommodation from any source outside the accommodation except other sanitary accommodation.

Interior finishes.

**19.** (1) The interior walls and ceilings of all parts of the crew accommodation shall be painted or covered with a suitable material.

(2) Paint shall be white or light in colour.

(3) Paints, varnishes and other surface materials which have a nitro-cellulose or other highly flammable base shall not be used in the crew accommodation.

(4) Un-upholstered parts of furniture and fittings shall be made of polished hardwood or of a smooth, rust-proof material, impervious to dirt and moisture, which is not likely to warp, crack or become corroded.

(5) Wooden parts of the furniture and fittings and any panelling or other wooden surfaces in the crew accommodation shall be finished externally with paint or varnish or by some other suitable means.

(6) All paints, varnish and other surface finishes in the crew accommodation shall be such that they can easily be kept clean.

(7) The interior of the crew accommodation and all furniture and fittings in it shall be so made, fitted and arranged as not to be likely to harbour dirt or vermin.

**20.** (1) Every sleeping room in the crew accommodation shall be marked on the inside with the marking specified in Part 1 of the Fifth Schedule.

Marking.

Fifth  
Schedule.

(2) Every space in the crew accommodation, except sleeping rooms, be marked either inside the space or on or over the door leading into it with whichever of the markings specified in Part 2 of the Fifth Schedule is appropriate.

(3) All markings shall—

- (a) be made in clear characters at a readily visible position on the ship's structure; and
- (b) be cut into the structure or marked in some other equally permanent way.

(4) No space in the crew accommodation shall be marked either inside or outside with any marking additional to the marking required by this regulation which could cause confusion by implying that the space is appropriated for use other than in accordance with the marking required by this regulation.

**21.** (1) Unless the circumstances are such that no members of the crew are required to sleep on board, sleeping rooms shall be provided for the crew.

Sleeping  
Rooms.

(2) Each of the following groups of persons shall be provided with sleeping rooms separate from those provided for the other group:

- (a) officers;
- (b) petty officers;
- (c) cadets;
- (d) ratings of the deck department other than petty officers;
- (e) ratings of the engine room department other than petty officers; and
- (f) ratings of the catering department other than petty officers.

(3) In relation to ships in which general purpose ratings are employed, subparagraphs (d) and (e) shall not apply and ratings of those two groups shall be counted as one group.

(4) The maximum number of persons accommodated in sleeping rooms shall be as follows:

- (a) one officer per room;
- (b) whenever practicable, one cadet per room, but not more than two per room;
- (c) wherever practicable one petty officer per room, but not more than two per room;
- (d) other rating—
  - (i) in ships other than passenger ships, not more than two persons per room;
  - (ii) in passenger ships, not more than four persons per room.

(5) When more than one person is accommodated in a sleeping room they shall be members of the same watch.

(6) An individual sleeping room shall be provided for each adult member of the crew, where the size of the ship, the activity in which it is to be engaged and its layout make this practicable.

(7) In ships other than passenger ships—

- (a) the minimum floor area provided for a single berth sleeping room for ratings shall be as follows:
  - (i) in ships of under 3,000 tons, 3.75 square metres;
  - (ii) in ships of 3,000 tons or over but under 10,000 tons, 4.25 square metres;
  - (iii) in ships of 10,000 tons or over, 4.75 square metres;
- (b) the minimum floor area provided per person in a two berth sleeping room for ratings shall be as follows:
  - (i) in ships of under 3,000 tons, 2.75 square metres;
  - (ii) in ships of 3,000 tons or over but less than 10,000 tons 3.25 square metres;
  - (iii) in ships of 10,000 tons or over, 3.75 square metres.

- (8) In passenger ships—
- (a) the minimum floor area provided in a single berth sleeping room for ratings shall be 3.75 square metres;
  - (b) the minimum floor area provided per person in a two, three or four berth sleeping room for ratings shall be as follows:
    - (i) in ships of under 3,000 tons, 2.35 square metres;
    - (ii) in ships of 3,000 tons or over, 3.00 square metres.
- (9) Where practicable in ships of 3,000 tons or over, a day room adjoining his sleeping room shall be provided for—
- (a) the Chief Officer; or
  - (b) the Chief Engineer.
- (10) In sleeping rooms for officers and cadets for whom no separate day room is provided the minimum floor area provided shall be as follows:
- (a) in the case of a sleeping room where two cadets are accommodated—
    - (i) in ships of under 3,000 tons, 10.0 square metres;
    - (ii) in ships of 3,000 tons or over, 12.0 square metres;
  - (b) in any other case—
    - (i) in ships of under 3,000 tons, 6.50 square metres;
    - (ii) in ships of 3,000 tons or over, 7.50 square metres.
- (11) In sleeping rooms for officers and cadets for whom a separate day room is provided the minimum floor area provided shall be—
- (a) in the case of a sleeping room where two cadets are accommodated, the minimum floor area required for ratings in subregulation (7)(b); and
  - (b) in any other case, the minimum floor area required for ratings in subregulation (7)(a).

LAWS OF TRINIDAD AND TOBAGO

MINISTRY OF THE ATTORNEY GENERAL AND LEGAL AFFAIRS

www.legalaffairs.gov.tt

728

Chap. 50:10

Shipping

[Subsidiary]

Shipping (Crew Accommodation) Regulations

(12) In determining the floor area of a room for the purpose of this regulation, spaces occupied by berths, lockers, seats or chests of drawers and other furniture shall be included in the measurement of the floor area but spaces which by reason of their small size or irregular shape cannot accommodate furniture and do not contribute to the area available for free movement shall not be so included.

(13) The sleeping room of the First or only Radio Officer shall be situated as near as practicable to the radio room.

Beds.

**22.** (1) Every sleeping room shall be fitted with a bed for each person accommodated in the room.

(2) The framework of each bed, and its lee boards or lee rails, if any, shall be constructed of metal or some other material which is hard, smooth and unlikely to become corroded.

(3) If the bed is constructed of tubular frames, the frames shall be completely sealed.

(4) There shall be unobstructed access to at least one side of each bed, and in particular where the adjacent sides of two beds in the room are parallel to each other or, when projected, make an angle of less than 90° with each other, the distance between those sides at any point shall not be less than 760 millimetres if the beds are in single tier and not less than 910 millimetres if they are in double tier.

(5) Where beds abut upon each other, they shall be separated by rigid screens made of wood or other suitable opaque material.

(6) Beds shall not be arranged in tiers of more than two.

(7) Beds shall not be fitted fore-and-aft along the ship's side unless the size of the room is such that it is impracticable to fit them elsewhere.

(8) Where beds are fitted along the ship's side, they shall be in single tier, except in a room in which there is no sidescuttle or in which any sidescuttle fitted is fitted clear of the beds.

UNOFFICIAL VERSION

UPDATED TO 31ST DECEMBER 2016

(9) No bed shall be fitted—

- (a) within 100 millimetres of a ventilation trunk used for circulating hot air; or
- (b) within 50 millimetres of a bulkhead or the ship's side unless the bed is so fitted—
  - (i) as to fill any gap by the bed which might harbour dirt or vermin; and
  - (ii) as to enable the bedding to be kept clean and dry.

(10) The distance from the bottom of the mattress of every bed to the floor of the room shall be at least 305 millimetres.

(11) In every double tier bed—

- (a) the upper berth shall be at least 760 millimetres below the lower side of the deckhead beams, or the ceiling if fitted below those beams, or other obstruction;
- (b) where the height of the sleeping room in which the bed is fitted is 2.30 metres or more, the lower berth shall be at least 910 millimetres below the upper berth;
- (c) where the height of the sleeping room in which the bed is fitted is less than 2.30 metres the lower berth shall be at least 840 millimetres below the upper berth.

(12) For the purposes of this regulation any measurements of vertical distances from a berth shall be taken from the bottom of the mattress of that berth and the height of the room shall be its height measured from the top of the floor beams to the top of the crown beams.

(13) Subject to subregulation (14) the minimum inside dimension of beds shall be adequate to accommodate mattresses of a size not less than two metres by 840 millimetres.

(14) In ships of 3,000 tons or over the minimum inside dimensions of beds provided for petty officers and officers shall be adequate to accommodate mattresses of a size not less than two metres by one metre.

LAWS OF TRINIDAD AND TOBAGO

MINISTRY OF THE ATTORNEY GENERAL AND LEGAL AFFAIRS

www.legalaffairs.gov.tt

730

Chap. 50:10

Shipping

[Subsidiary]

Shipping (Crew Accommodation) Regulations

(15) Every bed shall be fitted with either—

- (a) a spring bottom or spring under-mattress and a top mattress of a material which will resist damp and is unlikely to harbour vermin; or
- (b) a suitable resilient mattress fitted on a suitably ventilated base.

(16) A bottom of wood, canvas or dust-proof material shall be fitted to the upper berth of every double tier bed.

(17) Lee boards or lee rails shall be fitted to the upper berth of every double tier bed.

(18) Where a double tier bed is fitted—

- (a) a suitable portable ladder shall be supplied for access to the upper berth;
- (b) the ladder shall be so constructed that it hooks on to the lee rail to prevent any slipping when in use; and
- (c) suitable provision shall be made for its safe stowage when not in use.

Furniture and fittings in sleeping rooms.

**23.** (1) Every sleeping room shall be so planned and equipped as to ensure reasonable comfort for the occupants and to facilitate tidiness.

(2) Sleeping rooms for ratings shall be provided with the following minimum equipment:

- (a) for each occupant of the room—
  - (i) a clothes locker or wardrobe which shall be at least 1.70 metres high and have an internal sectional area of at least 0.20 square metres;
  - (ii) the locker or wardrobe shall be fitted with a shelf not less than 230 millimetres and not more than 380 millimetres below its top, with a rod for clothes hangers and with a secure lock or hasp for a padlock;
  - (iii) a drawer having a capacity of at least 0.056 cubic metres;

UNOFFICIAL VERSION

UPDATED TO 31ST DECEMBER 2016

- (iv) a comfortable seat; and
- (v) at least one coat hook in addition to any coat hooks which may be fitted in a locker or wardrobe;
- (b) a table or desk or a sliding leaf or top fitted to a chest of drawers and suitable for writing at;
- (c) a mirror, a cabinet for toilet requisites, a razor socket and strip light fixed on or adjacent to such mirror and cabinet;
- (d) a book rack;
- (e) a curtain, blind or jalousie for each sidescuttle or window;
- (f) a curtain fitted to each berth, unless the room accommodates only one person;
- (g) in ships of under 25,000 tons, a carpet runner at the side of each bed or tier of beds as the case may be;
- (h) in ships of 5,000 tons or over other than passenger ships, a washbasin, unless a washbasin is fitted in a private or semi-private bathroom provided for the occupants of that sleeping room; and
- (i) a splash back plate or other means of protection for the wall above the washbasin, if any.

(3) Every sleeping room for a petty officer shall be provided with the following minimum equipment in addition to the equipment specified in subregulation (2):

- (a) a second drawer having a capacity of at least 0.056 cubic metres;
- (b) a rack suitable for holding—
  - (i) a tumbler; and
  - (ii) one drinking water bottle, except in a sleeping room in which a supply of drinking water is laid on.

(4) In every sleeping room in which more than one rating is accommodated, every drawer shall be fitted with a secure lock or hasp for a padlock.

(5) Subject to the provisions of subregulation (6) every sleeping room for an officer shall be provided with the following minimum equipment:

- (a) a wardrobe which shall be at least 1.68 metres high and have an internal sectional area of at least 0.30 square metres;
- (b) at least three drawers having a total capacity of 0.28 cubic metres;
- (c) a chair with arm rests;
- (d) at least two coat hooks in addition to any coat hook which may be fitted in the wardrobe;
- (e) a settee at least 1.83 metres long or where such a settee cannot be accommodated in the room without inconveniencing the occupant, a fully upholstered easy chair with closed arms;
- (f) a writing desk, fitted with drawers additional to those specified in paragraph (b);
- (g) a book case if the room accommodates a Chief Officer or Chief or Second Engineer in any ship, or a First Radio Officer in a passenger ship;
- (h) a book case or book rack if the room accommodates some other officer;
- (i) a curtain, blind or jalousie fitted to each sidescuttle or window;
- (j) a mirror suitable for toilet purposes;
- (k) a cabinet for toilet requisites, a razor socket and strip light fixed on or adjacent to such cabinet or to the mirror;
- (l) a rack suitable for holding—
  - (i) a tumbler; and
  - (ii) a drinking water bottle, except in a sleeping room in which a supply of drinking water is laid on;
- (m) in ships of 5,000 tons or over other than passenger ships, a washbasin, unless a washbasin is fitted in a private or semi-private bathroom provided for the occupant of that sleeping room;

(n) a splash back plate or other means of protection for the wall above the washbasin, if any.

(6) Any of the equipment referred to in subregulation (5)(e), (f), (g) and (h) may, instead of being provided in the officer's sleeping room, be provided in a day room appropriated for his exclusive use.

(7) Any of the equipment referred to in subregulation (2)(c), (3)(b) or (5)(k), (l) and (m) may, instead of being provided in a sleeping room accommodating one person, be provided in a private bathroom appropriated for his use.

(8) Sleeping rooms for cadets shall so far as is reasonably practicable be provided with the equipment required by subregulation (5) to be provided for officers, provided that any of the equipment referred to in subregulation (5)(e), (f), (g) and (h) may, instead of being provided in the cadet's sleeping room, be provided in a day room or study appropriated for the exclusive use of cadets.

(9) No locker intended to contain food shall be fitted in any sleeping room.

**24.** (1) Unless the circumstances are such that no members of the crew are required to mess on board, mess rooms shall be provided for the crew. Mess rooms.

(2) Each mess room shall be large enough to accommodate the greatest number of persons likely to use it at any one time.

(3) Mess rooms shall be separate from sleeping rooms.

(4) In ships of under 300 tons a mess room, if not combined with a galley, may be combined with sleeping accommodation if it is impracticable to provide a separate mess room.

(5) In every ship of 500 tons or over, each of the following groups of persons shall be provided with a mess room separate from that provided for any other group:

- (a) officers; and
- (b) ratings.

(6) Unless the officers are accommodated in widely separated parts of the ship the mess room provided pursuant to subregulations (3) and (4) for officers shall be a single mess room for the use of all officers.

(7) In every ship of 1,000 tons or over the mess rooms provided pursuant to subregulation (3) for the following groups of ratings:

- (a) petty officers of the deck department;
- (b) petty officers of the engine room department;
- (c) other ratings of the deck department; and
- (d) other ratings of the engine room department,

shall consist of—

- (i) four separate mess rooms, one for use by each group;
- (ii) a combined mess room to be shared by two groups and two separate mess rooms for use by the other two groups;
- (iii) two combined mess rooms, each to be shared by two groups; or
- (iv) a single mess room for use by all four groups.

(8) A combined mess room for use by two groups shall not be shared by petty officers of one department and other ratings of the other department, but may be shared by any other two groups.

(9) In every ship of 5,000 tons or over which either is an unlimited trade ship or is a Caribbean trade ship with a catering department of more than five persons, a separate mess room shall be provided for use by ratings of the catering department, except where the mess room provided for ratings of other departments is the single mess room referred to in subregulation (7)(iv).

(10) Where no separate mess room is provided for ratings of the catering department messing accommodation shall be provided for them in the mess rooms provided for ratings of other departments.

(11) Cadets shall be provided with a separate mess room or with mess accommodation in the officer's mess room.

(12) The floor area of every mess room shall be not less than 1 square metre per person for as many persons as are likely to use the room at any one time for messing.

**25.** (1) Every mess room shall be provided with sufficient tables to allow a table space of at least 510 millimetres per person, measured along the edge of a table, for as many persons as are likely to use the room at any one time.

Furniture and fittings in mess room.

(2) Each table shall be at least 610 millimetres wide if seats are provided on both sides of the table and at least 380 millimetres wide if seats are provided for only one side of the table.

(3) One seat per person shall be provided for as many persons as are likely to use the room at any one time.

(4) The seats shall consist of a single chair or, in the case of seats placed directly alongside a bulkhead or the ship's side, of single chairs or settees.

(5) Chairs shall be fitted with arm rests unless chairs with arm rests are available in a separate recreation room for the persons using the mess room.

(6) Settees shall be at least 380 millimetres wide and shall have upholstered or padded seats.

(7) Every mess room provided for persons who do not provide their own food shall be provided with adequate stowage space for mess utensils in a sideboard, dresser or in separate lockers.

(8) Every mess room provided for persons who do provide their own food shall be fitted with a storage locker for each person likely to use the room.

(9) Each such storage locker shall be—

- (a) large enough to contain one person's mess utensils and supply to food;
- (b) fitted with a secure lock or hasp for a padlock;
- (c) so fitted as to be clear of the floor by at least 300 millimetres; and
- (d) adequately ventilated.

(10) Lockers provided in pursuance of subregulations (7), (8) and (9) may be fitted either in the mess room or in a suitable place readily accessible from it.

(11) In ships of 500 tons or over the following equipment or its equivalent shall be fitted in, or in a suitable space adjacent to, every mess room and shall be readily accessible at all times by the crew using the mess room:

- (a) a dresser or sideboard, which may be the dresser or sideboard referred to in subregulation (7);
- (b) a refrigerator;
- (c) a hot press, except in ships of under 1,000 tons;
- (d) a sink;
- (e) a supply of cold drinking water;
- (f) a means of heating drinking water for hot beverages; and
- (g) an electric toaster.

(12) The equipment referred to in subregulation (11) shall be adequate in size for the number of persons using the mess room.

Recreation  
spaces.

**26.** (1) Recreation rooms, conveniently situated and appropriately furnished shall be provided for officers and for ratings.

(2) Where these are not provided separately from the mess room the latter shall be planned, furnished and equipped to give recreational facilities.

(3) Furnishings for recreation accommodation shall as a minimum include a bookcase and facilities for reading, writing and where practicable, for games.

(4) In every ship of 8,000 tons or over the following shall be provided for the crew:

- (a) facilities for watching films and television;
- (b) a separate hobbies and games room; and
- (c) where practicable, a swimming pool.

(5) In every ship, deck space permanently reserved for the use of the crew for recreational purposes shall be provided on an open deck.

(6) The space shall be adequate in area having regard to the number of persons in the crew and the size of the ship.

**27.** (1) In every ship of 3,000 tons or over two appropriately furnished rooms shall be provided solely for use as offices.

(2) One of those offices shall be appropriated for use by all the officers of the deck department and the other shall be appropriated for use by all the officers of the engine room department.

**28.** (1) The following private and semi-private bathrooms shall be provided for officers:

- (a) in ships of 5,000 tons or over but less than 15,000 tons at least five officers' sleeping rooms shall be provided with adjoining private bathrooms for the use of the officers occupying those sleeping rooms;
- (b) in ships of 15,000 tons or over every officer's sleeping room shall be provided with an adjoining private bathroom for the use of the officer occupying that sleeping room;
- (c) in addition, in ships of 10,000 tons or over but less than 15,000 tons, every officer's sleeping room which is not provided with an adjoining private bathroom shall have a semi-private bathroom appropriated to it which shall comply with the requirements of subregulation (3) as regards semi-private bathrooms for officers.

(2) In ships of 25,000 tons or over, other than passenger ships every rating's sleeping room which is not provided with a private bathroom shall have a semi-private bathroom appropriated to it which shall not be shared by petty officers and other ratings.

(3) Every semi-private bathroom shall be situated either in an inter-communicating compartment between the sleeping rooms of the two persons for whose use it is appropriated or if the bathroom is for ratings it may be situated opposite or approximately opposite the entrance or entrances to their sleeping room or rooms.

- (4) Every semi-private bathroom shall be—
- (a) fitted with a bath or shower, a water closet pedestal and other items specified in these Regulations; and
  - (b) unless a washbasin is provided in each sleeping room for which the bathroom is appropriated, fitted with a washbasin.
- (5) Every private bathroom shall be fitted with a bath or shower, a water closet pedestal, a washbasin and other items specified in these Regulations.
- (6) Sanitary accommodation shall be provided for the use of those members of the crew for whom no private or semi-private sanitary accommodation is provided and the accommodation provided shall consist of separate accommodation for each of the following groups:
- (a) officers and cadets;
  - (b) ratings; and
  - (c) female staff.
- (7) The following equipment shall be provided in the sanitary accommodation pursuant to subregulation (6) for every group of six persons or fewer:
- (a) one bath or shower;
  - (b) one washbasin;
  - (c) one mirror suitable for toilet purposes; and
  - (d) one water closet.
- (8) In determining the quantity of equipment to be provided pursuant to this subregulation, no account shall be taken of any equipment provided in sanitary accommodation in a permanent hospital.
- (9) The minimum number of water closets provided in ships—
- (a) 500 tons or over but under 800 tons, shall be three;
  - (b) 800 tons or over but under 3,000 tons, shall be four;
  - (c) 3,000 tons or over, shall be six,

and water closets additional to those required by the preceding subregulations shall be provided where necessary to make up the number.

(10) The water closets provided pursuant to subregulation (7) may be taken into account for the purpose of determining these numbers.

(11) Sanitary accommodation provided pursuant to subregulation (5) shall be situated close to the sleeping rooms of the persons for whose use it is provided.

(12) Baths and showers provided for one group of persons shall be situated in or adjacent to a room containing the washbasins provided for that group.

(13) Access to sanitary accommodation provided pursuant to subregulation (5) shall where reasonably practicable be from a passageway and shall not be from a mess room or sleeping room, except where sanitary accommodation is provided for the exclusive use of the occupants of not more than two sleeping rooms accommodating not more than four persons in all, where access to it may be directly from those sleeping rooms.

(14) Every washbasin, bath and shower tray shall be made of a suitable material with a smooth and impervious surface not likely to crack, flake or corrode.

(15) Every washbasin, bath and shower tray shall be fitted with an efficient and hygienic discharge system and in particular the wastepipe shall be fitted in a way which will minimise the risk of obstruction and facilitate cleaning.

(16) Every washbasin, bath and shower space shall be of suitable size.

(17) Screening to ensure privacy shall be provided for any bath or shower which is in the same room as any washbasin or other bath or shower unless the room is a private or semi-private bathroom.

(18) The screening shall be made of a robust and opaque material and shall be rigid on at least three sides of every bath or shower.

LAWS OF TRINIDAD AND TOBAGO

MINISTRY OF THE ATTORNEY GENERAL AND LEGAL AFFAIRS

www.legalaffairs.gov.tt

740

Chap. 50:10

Shipping

[Subsidiary]

Shipping (Crew Accommodation) Regulations

(19) Wherever reasonably practicable the space screened shall be large enough for a person to undress in it in comfort.

(20) Every bath and shower shall be provided with a handrail, grating or mat.

(21) Except in private or semi-private bathrooms the showers shall be provided with kerbs and individual drainage.

(22) Hot and cold fresh water shall be laid on to all washbasins, baths and showers.

(23) The hot water shall be at a constant temperature of at least 66°C and shall be heated by thermostatically controlled calorifiers of adequate capacity or by some equally safe and efficient means.

(24) Every shower shall be provided with an anti-scalding mixing valve which shall be set in such a way that the temperature of the shower water can be varied by the person using it to any temperature between the ambient temperature and a temperature of at least—

- (a) in the case of a thermostatically controlled mixing valve, 38°C but not more than 43°C; or
- (b) in the case of any other mixing valve, 35°C but not more than 40°C.

(25) Where there is an access to a water closet from an open deck, such access being additional to that required by regulation 11(2) the access to it shall, where practicable, be screened so as to ensure privacy.

(26) Where access to a water closet is from a passageway, other than a passageway leading only to water closets, a lobby shall—

- (a) where practicable be provided at the entrance to the water closet;
- (b) where that is not practicable, the water closet shall be provided with a self-closing door which is close-fitting and has no apertures.

(27) Subregulation (26) need not be complied with where adequate mechanical exhaust ventilation arrangements are provided in those spaces.

UNOFFICIAL VERSION

UPDATED TO 31ST DECEMBER 2016

(28) Every water closet pedestal shall be fitted in a closet separated from all other parts of the crew accommodation by bulkheads which comply with the requirements of regulation 8.

(29) A water closet need not be separated by bulkheads complying with the requirements of regulation 8 from—

- (a) another water closet;
- (b) a urinal; or
- (c) where the water closet is served by a trunked mechanical exhaust ventilation system which effectively removes the odours from it, from washing accommodation,

where it is separated from that other water closet, urinal or washing accommodation by a partition made of steel or other suitable material and open at the top and bottom.

(30) Subregulations (18) and (19) need not be complied with in respect of partitioning of a water closet pedestal in a private or semi-private bathroom.

(31) Every water closet shall be provided with exhaust ventilation direct to the open air or to another water closet which is itself ventilated directly to the open air.

(32) Every water closet shall be provided with the following:

- (a) a water closet pedestal of a single type with a pan of white vitreous china or other suitable material;
- (b) a hinged seat of a suitable hard smooth impervious material;
- (c) a trap with a metal inspection plate;
- (d) an efficient ventilator connected to the outlet;
- (e) an adequate flush of water which shall always be available and supplied through self-closing non-concussive supply valves with a portable seating of metal which is not likely to become corroded;
- (f) a connection to an approved vacuum discharge pipe system or a soil pipe of not less than 100 millimetres internal diameter, so constructed as to facilitate cleaning and minimise the risk of obstruction;

- (g) the pipe shall be adequately ventilated and shall have a direct overboard outfall fitted with a storm valve unless it is connected by an efficient and hygienic system to a collecting tank or sewage plant;
- (h) a device for holding toilet paper; and
- (i) a hand rail or grip.

(33) Where the water closets specified in subregulation (32) would be unsuitable for use by some members of the crew because of their distinctive national habits and customs then those water closets may be suitably adapted or other suitable closets shall be provided for those members of the crew so however, that the sanitary accommodation shall be equal or comparable to the standard otherwise required by this regulation.

(34) In ships of 1,600 tons or over, the following additional sanitary accommodation shall be provided:

- (a) a separate room containing a water closet and a washbasin easily accessible from the navigating bridge for the use of those working in that area;
- (b) a separate room containing a water closet and a washbasin within or near to the engine room control compartment or, in ships not fitted with such a compartment, within easy access of the propelling machinery space;
- (c) a separate room containing a water closet and a washbasin easily accessible from the galley for the use of those working in that area; and
- (d) except in ships in which single berth sleeping rooms and private or semi-private bathrooms are provided for the use of all engine room personnel, washing accommodation fitted with showers, washbasins and mirrors sufficient in number having regard to the number of such personnel not provided with single berth sleeping rooms and private or semi-private bathrooms and situated in a place outside but conveniently close to the propelling machinery space.

(35) Unless other adequate means of washing down the accommodation are provided, a salt water tap with a suitable hose connection shall be fitted in sanitary accommodation, other than private or semi-private bathrooms.

**29.** (1) Cold drinking water for purposes of drinking, cooking and dishwashing shall be laid on to taps in galleys, bars and pantries, and in the case of any mess room provided for members of the crew for whom no pantry is provided, to a tap in that mess room.

Supply of drinking water.

(2) The drinking water shall be supplied from tanks of suitable capacity taking account of the number of the crew and the maximum number of days that may elapse between successive replenishments of water.

(3) If the water supplied to the sanitary accommodation is of the standard required for drinking water the storage tanks may be combined.

(4) If they are combined the total capacity shall be suitably increased.

(5) The drinking water storage tanks, any manholes leading into them, and all pipes and other parts of the distribution system for the drinking water shall be so arranged and constructed as to allow efficient maintenance and prevent any risk of contamination.

(6) Where a distilling or evaporating plant is provided for the supply of drinking water, the storage capacity may be reduced from that specified in subregulation (2), but the tanks shall still be sufficient to provide at least two days' supply.

(7) Where gravity service tanks are fitted they shall be directly connected with the ship's main drinking water storage tanks.

(8) Where drinking water is produced by plant installed on board the water so produced shall be treated by an automatic means of disinfection acceptable to the Minister.

(9) Where drinking water is used for flushing water closets, supplying engine auxiliaries or for any other purpose than drinking, precautions shall be taken to ensure that the drinking water supply cannot be contaminated as a result of that use.

(10) In every ship of 1,000 tons or over a cooling tank or other suitable means of cooling a supply of drinking water shall be provided and the water so cooled shall be laid on so that it is readily available to the crew.

(11) In ships of 1,000 tons or over any primary pumping necessary for the supply of drinking water in crew accommodation shall be by mechanical power.

(12) Alternative pumping arrangements shall be provided to supply drinking water in the event of a breakdown of the primary pumping system.

(13) When an enclosed pressurised system is employed, the pumps provided for the alternative pumping system shall be power operated and all pumps required for primary and alternative pumping shall be fitted with automatic controls.

Supply of fresh water.

**30.** (1) The fresh water laid on to washbasins, baths and showers shall be supplied from tanks of suitable capacity taking account of the number of the crew and the maximum number of days that may elapse between successive replenishments of water.

(2) If a plant is installed on board for supply of fresh water the storage capacity may be reduced, but the tanks shall still be sufficient to provide at least two days supply.

(3) The washing water storage tanks, any manholes leading into them, and all pipes and other parts of the distribution system for the washing water shall be so arranged and constructed as to allow efficient maintenance and minimise any risk of contamination.

(4) Where gravity service tanks are fitted they shall be directly connected with the ship's main fresh water storage tanks.

(5) All plant installed on board for the production of fresh water shall be fitted with automatic means of disinfection acceptable to the Minister.

(6) In ships of 1,000 tons or over any primary pumping necessary for the supply of fresh water in crew accommodation shall be by mechanical power.

(7) Alternative pumping arrangements shall be provided to supply fresh water in the event of a breakdown of the primary pumping system.

(8) When an enclosed pressure system is employed, pumps provided for the alternative pumping system shall be power operated and all pumps required for primary and alternative pumping shall be fitted with automatic controls.

**31.** (1) In all ships, except where due to the nature of the service the crew are not accommodated overnight, facilities for washing, drying and ironing clothes shall be provided for officers ratings on a scale appropriate to the size of the crew and the normal duration of the voyage.

Facilities for washing and drying clothes and for hanging oilskins and working clothes.

(2) These facilities shall, wherever possible, be located within easy reach of their accommodation and arrangements shall be made to ensure separate availability of the facilities to officers and ratings.

(3) The facilities to be provided shall include—

- (a) suitable sinks and washing machines, which may be installed in washrooms if provision of a separate laundry facility is not reasonably practicable, with an adequate supply of hot and cold fresh water or means of heating water;
- (b) drying machines and adequately heated and ventilated drying rooms unless the drying machines are of a type which dry clothes completely; and
- (c) electric irons and ironing boards or their equivalent.

(4) Adequately ventilated compartments or lockers for use solely for hanging oilskins and other working clothes shall be provided in a place outside but conveniently near to the sleeping rooms.

(5) Separate compartments or lockers for officers and ratings.

(6) Where washing accommodation is provided in accordance with regulation 28(34)(d) such accommodation shall

be provided with a clothes locker for each member of the engine room department not provided with a single berth sleeping room and a private or semi-private bathroom.

(7) Clothes lockers so provided shall be considered as complying with the requirements of subregulation (4) in respect of lockers for working clothes.

Galleys.

**32.** (1) Except in ships in which no member of the crew will be required to mess on board, a galley suitably positioned clear of working areas and situated as close as practicable to the mess rooms shall be provided for the preparation of food for the crew.

(2) Every galley shall be provided with all equipment necessary to enable food in sufficient quantity to be properly and readily prepared for all persons whom the galley is intended to serve and served hot to them in the mess room in all weathers.

(3) All fixed equipment shall be so arranged that it and all the spaces round and behind it can easily be kept clean.

(4) Every galley shall be provided with facilities for washing up.

(5) Hot and cold fresh drinking water shall be laid on to any sink or other washing up facility in a galley.

(6) In ships of 3,000 tons or over there shall, in addition, be provided a washbasin supplied with hot and cold fresh water.

(7) No salt water tap shall be fitted in the galley nor in any place at which food may be prepared.

(8) All furniture and fittings in the galley shall be made of a material which is impervious to dirt and moisture.

(9) All metal parts of furniture and fittings shall be rustproof.

(10) The bottoms of all fitted furniture shall be either flush with the deck or fitted high enough to enable the deck space beneath to be easily kept clean.

(11) The ventilation in the galley shall be so arranged as to ensure an adequate supply of fresh air and the efficient discharge of fumes into the open air.

(12) Equipment additional to that required by regulation 16 shall be provided where necessary for that purpose.

(13) In particular every galley in a ship of 1,000 tons or over shall be provided with exhaust fans to draw off fumes from the cooking appliances and discharge them into the open air.

(14) The floor of every galley shall be provided with sufficient gutters and scuppers to ensure that it is efficiently drained.

(15) The scuppers, which shall be trapped, shall be led overboard or to an enclosed tank which has a mechanically operated suction pump.

(16) A connection suitable for a hose for washing down shall be provided at a height not less than 450 mm above the deck, on a fresh waterpipe in every galley.

**33.** (1) In every ship, except one in which each member of the crew provides his own food, one or more storerooms shall be provided for the storage of dry provisions for the crew. Dry provision storerooms.

(2) The rooms shall be fitted with sufficient shelves, cupboards and bins having regard to the maximum period likely to elapse between successive replenishments of stores and to the maximum number of persons for whom food is to be provided.

(3) Shelves, cupboards and bins shall be so constructed as to enable them to be effectively cleaned.

(4) Access to every dry provision storeroom shall be obtained from a passageway, galley, pantry or other dry provision storeroom.

(5) Every dry provision storeroom shall be so situated, constructed and ventilated as to minimise the risk of deterioration of the stores through heat, draught, condensation or infestation by insects or vermin. In particular a dry provision storeroom shall not—

- (a) be situated over a propelling machinery space, boiler room or any other space which is subject to abnormal heat; or
- (b) adjoin a galley, propelling machinery space or other space which is subject to abnormal heat,

unless the division between the storeroom and that space is adequately insulated.

(6) A dry provision storeroom shall be used exclusively for the storage of dry provisions.

Cold store rooms and refrigerating equipment.

**34.** (1) Subject to subregulation (2)—

- (a) in every unlimited trade ship of 1,000 tons or over cold storerooms shall be provided for the storage of perishable provisions;
- (b) in every unlimited trade ship of under 1,000 tons and in every Caribbean trade ship there shall be provided for the storage of perishable provisions for the crew either cold storerooms or adequate alternative cold storage facilities.

(2) Subregulation (1) shall not apply to ships in which each member of the crew provides his own food.

(3) Cold storerooms or other facilities provided shall be so constructed as to enable them to be effectively cleaned and shall be adequate in size having regard to the number of persons in the crew and the period likely to elapse between successive replenishments of stores.

(4) Access to every cold storeroom shall be from a passageway, galley or pantry or from another cold storeroom.

(5) Every cold storeroom shall be served by refrigerating machinery.

(6) The space in which that machinery is situated shall be separated from all other parts of the crew accommodation by bulkheads complying with the requirements of regulation 8.

(7) It shall be adequately ventilated by at least two ventilators to the open air one of which shall be fitted with an exhaust fan and shall have its inlet near the bottom of the space.

(8) Access to that space shall, where practicable, be by means of a hinged door from an open deck.

(9) If the door opens into any part of the crew accommodation, the door shall be of steel, gastight and self-closing.

(10) The refrigerating equipment shall be such that with the refrigerating machinery working not more than 12 hours a day a maximum temperature of  $-10^{\circ}\text{C}$  can be maintained in any cold storeroom intended to be used only for the storage of meat, and a maximum temperature of  $-18^{\circ}\text{C}$  can be maintained in any cold storeroom intended to be used for deep frozen foods.

(11) In any storeroom intended to be used for the storage of meat and deep frozen foods, the equipment shall be capable of maintaining a maximum temperature of  $18^{\circ}\text{C}$ , and a temperature of  $7^{\circ}\text{C}$  in any storeroom intended to be used for the storage of fresh vegetables.

(12) A red warning light outside every cold storeroom or group of cold storerooms shall be included in the lighting circuit of each such room or groups of rooms.

(13) Every cold storeroom shall be fitted with an internal means of sounding an external alarm and with a means of releasing the door fastenings from the inside.

(14) Refrigerating machinery making use of ammonia or methyl chloride as a refrigerant shall not be installed.

**35.** (1) Every ship with a crew of 15 or more persons which is intended to be at sea on any occasion for a continuous period of more than three days shall be provided with a permanent hospital for the crew. Hospitals.

(2) The hospital shall not at any time be used for any purpose other than the treatment of sick persons.

(3) In every other ship, except one in which all officers and ratings have single berth sleeping rooms, a suitable room shall be appropriated for use, in case of need, as a temporary hospital.

(4) When that room is in use as a temporary hospital it shall not be used for any purpose other than the treatment of sick persons.

(5) Every hospital, whether permanent or temporary, shall be so situated that it is as quiet and comfortable as possible and is readily accessible in all weathers—

(a) from the sleeping room of the member of the crew who is, and is employed as, a duly qualified doctor or a qualified nurse; or

**LAWS OF TRINIDAD AND TOBAGO**

MINISTRY OF THE ATTORNEY GENERAL AND LEGAL AFFAIRS

www.legalaffairs.gov.tt

750

**Chap. 50:10**

*Shipping*

[Subsidiary]

*Shipping (Crew Accommodation) Regulations*

(b) if no such doctor or nurse is carried, from the master's accommodation.

(6) The minimum width of the entrance to any permanent hospital shall where practicable be 760 millimetres.

(7) Every hospital, whether permanent or temporary, shall be so situated and arranged that a stretcher can be easily carried into it and placed alongside at least one single tier bed.

(8) Every permanent hospital shall be provided with at least one bed for every 50 or fraction of 50 members of the crew.

(9) At least one bed in every permanent hospital shall be a single tier bed, and shall wherever practicable be so placed that it is accessible from both sides and from the foot.

(10) If double tier beds are provided in a hospital the upper tier shall be either hinged or removable.

(11) The minimum inside dimensions of every bed in a permanent hospital shall be adequate to accommodate mattresses of a size two metres by 840 millimetres.

(12) In all other respects beds in permanent hospitals shall comply with the requirements set out in regulation 22.

(13) Any room in a permanent hospital in which a bed is placed (in this regulation called the "ward") shall, unless it is served by an air-conditioning system or a trunked mechanical ventilation system, be fitted with an electric fan.

(14) All side scuttles and windows in the ward, and all skylights therein which are exposed to the direct rays of the sun shall be provided with curtains or blinds.

(15) Every permanent hospital, even where served by an air-conditioning system or a trunked mechanical ventilation system, shall be provided in addition with a natural system of inlet and exhaust ventilation to the open air independent of any ventilators provided for other parts of the ship and complying with the requirements of regulation 16(10).

UNOFFICIAL VERSION

UPDATED TO 31ST DECEMBER 2016

(16) Any radiator in the ward shall be fitted as far away from the head of any bed as is practicable.

(17) Every permanent hospital shall be provided with a portable electrical lamp in addition to the lighting required by regulation 15.

(18) The lamp shall be capable of emitting 600 lumens.

(19) The following items of equipment shall be provided for each bed in the hospital ward, and shall be within reach of that bed:

- (a) a locker approximately 305 millimetres square by 610 millimeters high, fitted with a flat top and a shelf;
- (b) a water bottle;
- (c) a tumbler; and
- (d) an electric bell-push communicating with the sleeping room of the doctor, nurse or other person in charge of the patient.

(20) The following items of equipment shall be provided in every ward:

- (a) seats adequate in number having regard to the number of beds in the ward;
- (b) a clothes locker, additional to any lockers provided pursuant to subregulation (19)(a), complying with the requirements of regulation 23(2)(a)(i); and
- (c) a box cover to conceal a bedpan.

(21) A washbasin of a capacity of at least 7 litres and with hot and cold water laid on to it shall be fitted in every permanent hospital either in the ward or in a bathroom in washing accommodation in the hospital.

(22) In ships of 5,000 tons or over a bath at least 1.35 metres in internal length shall be fitted in washing accommodation in the hospital.

(23) Every washbasin or bath in a permanent hospital shall comply with the requirements of regulation 28 and where practicable, except in ships provided with a collecting tank or

LAWS OF TRINIDAD AND TOBAGO

MINISTRY OF THE ATTORNEY GENERAL AND LEGAL AFFAIRS

www.legalaffairs.gov.tt

752

Chap. 50:10

Shipping

[Subsidiary]

Shipping (Crew Accommodation) Regulations

sewage plant the discharge system shall be separate from any other discharge system in the ship.

(24) A scupper at least 50 millimetres in diameter shall be fitted in the lowest part of any room in a hospital in which a bath is fitted and in any room in which a basin is fitted unless that room is the ward.

(25) A water closet pedestal and the other items specified in regulation 28(32) shall be fitted in every permanent hospital either in a separate closet or in washing accommodation in the hospital.

(26) Access to the water closet or, if the water closet pedestal is fitted in washing accommodation, access to that washing accommodation shall be obtained either directly from the ward or from a lobby within the hospital.

(27) The door to that water closet or washing accommodation shall open outwards and any door catch fitted to it shall be capable of being opened from the outside.

(28) The water closet or other room in which the water closet pedestal is fitted shall, unless it is served by a trunked mechanical exhaust ventilation system which effectively removes the odours from it, be provided with a gastight self-closing door.

(29) All washbasins, baths, showers and water closets fitted in a hospital shall comply with the requirements of regulation 28(14), (15), (16), (28) and (32).

(30) In passenger ships, one hospital may be provided to serve both crew and passengers.

(31) In such a case separate male and, except where there are no female members of the crew, female wards and sanitary accommodation shall be provided for the exclusive use of the crew.

(32) The floor covering in every permanent hospital shall, so far as is practicable, be free from joins.

Medical cabinet.

**36.** (1) A cabinet or other suitable facility for storing medicines and other medical stores, which the ship is required by

UNOFFICIAL VERSION

UPDATED TO 31ST DECEMBER 2016

Regulations made under section 149 of the Act to carry for the crew shall be well ventilated and fitted in a place in the crew area of the ship which—

- (a) is always dry;
- (b) is readily accessible from, but not sited in, the permanent or temporary hospital; and
- (c) is not subject to abnormal heat.

(2) Where a medical cabinet is required it shall be provided with the following:

- (a) an outer door with an efficient lock;
- (b) where controlled drugs are to be stored an inner cupboard fitted with a door and a lock which cannot be opened by the same key as the lock to the outer door;
- (c) suitable arrangements for the storage of the medicines, medical stores and associated measuring devices all as required by the regulations referred to in subregulation (1); and
- (d) a dispensing counter with a surface that can be easily kept clean.

(3) Where a medical cabinet is fitted it shall be lit by an electric light, which may be inside or immediately outside it, which enables the contents to be clearly seen.

**37.** (1) Subject to subregulation (4), the crew accommodation other than a recreation space on the open deck shall be protected by means of screening against the admission of mosquitoes.

Protection from mosquitoes.

(2) The screening which shall be made of rust-proof wire or other suitable material shall be fitted to or provided for all sidescuttles and windows and skylights which are capable of being opened and all natural ventilators and all doors leading to an open deck.

(3) Any screening door which is fitted pursuant to this regulation and leads directly into a permanent or temporary hospital shall be of a self-closing type.

(4) In crew accommodation which is fitted with an air-conditioning system screening need not be provided for any sidescuttles or windows which are fitted with special locking arrangements and which, except where the sidescuttles and windows are used for escape purposes, can be unlocked only with the consent of the master if all doors leading from that crew accommodation to the open deck are of the self-closing type.

Maintenance  
and inspection  
of crew  
accommodation.

**38.** (1) The crew accommodation shall be maintained in a clean and habitable condition and all equipment and installations required by these Regulations shall be maintained in good working order.

(2) Every part of the crew accommodation, except store-rooms, shall be kept free from stores and other property not belonging to or provided for the use of persons for whom that part of the accommodation is appropriated, and in particular no cargo shall be kept in any part of the crew accommodation.

(3) The master of the ship or an officer appointed by him for the purpose shall inspect every part of the crew accommodation at intervals not exceeding 7 days and shall be accompanied on the inspection by at least one member of the crew.

(4) The master of the ship shall cause to be entered in the ship's official log book a record of—

- (a) the time and date of the inspection;
- (b) the names and ranks of the persons making the inspection; and
- (c) particulars of any respect in which the crew accommodation or any part of it was found by any of the persons making the inspection not to comply with this Part of these Regulations.

**PART II**

**REQUIREMENTS TO BE COMPLIED WITH BY SHIPS  
REGISTERED IN TRINIDAD AND TOBAGO BEFORE  
THE DATE ON WHICH THESE REGULATIONS COME  
INTO OPERATION**

**39.** In this Part—

Interpretation.

“Act” means the Shipping Act;

“apprentice” includes a cadet and a midshipman;

“Chief Officer” includes a first mate and an only mate;

“crew” means seamen and apprentices;

“fishing vessel” includes a fishery research vessel but does not include a fishery protection vessel;

“passenger” and “passenger ship” have the same meanings as in section 2 of the Act;

“sanitary accommodation” means washing accommodation and accommodation containing water closets or urinals;

“sleeping room” does not include a hospital ward;

“special ratings” are ratings with distinctive national habits and customs;

“steamer” includes a ship propelled by electricity or other mechanical power;

“tons” means gross tons;

“trunked mechanical ventilation system” means a system of ventilation complying with the specifications set forth in Appendix 2 to the Sixth Schedule;

Sixth Schedule.

“washing accommodation” does not include—

(a) any sleeping room or hospital ward whether or not provided with a washbasin, bath or shower; or

(b) any room appropriated for use only as a laundry;

LAWS OF TRINIDAD AND TOBAGO

MINISTRY OF THE ATTORNEY GENERAL AND LEGAL AFFAIRS

www.legalaffairs.gov.tt

756

Chap. 50:10

Shipping

[Subsidiary]

Shipping (Crew Accommodation) Regulations

“whaling” includes the taking and treatment of seals and walruses and references to whales shall be construed accordingly.

Application  
Sixth Schedule.

**40.** This Part and the Sixth Schedule applies to every ship registered in Trinidad and Tobago the keel of which was laid or which is at a similar stage of construction before the date on which these Regulations come into operation, except—

- (a) a ship to which Part I of these Regulations applies;
- (b) fishing vessels;
- (c) vessels primarily used for sport or recreation; and
- (d) government ships operated for non-commercial purposes,

unless or until she is reconstructed or substantially altered.

Exemptions.

**41.** Any exemption or permission given with respect to a ship which was valid immediately before the date of the coming into operation of these Regulations shall, until that exemption or permission is revoked—

- (a) be treated and have effect for the purposes of this Part of these Regulations as if it were an exemption granted under section 147(3) of the Act; and
- (b) be construed as if it related to such of those requirements set out in the Sixth Schedule.

Sixth Schedule.

Duration of  
exemption.

**42.** Any such exemption or permission which is expressed to remain in force for a limited period shall remain in force, unless renewed, only until the expiry of that period.

---

UNOFFICIAL VERSION

UPDATED TO 31ST DECEMBER 2016

**FIRST SCHEDULE**  
**DECK COVERINGS**

Regulation  
10(6).

The material referred to regulations 9(1)(a)(ii) and 10(6), (7) and (8) shall—

- (a) provide a good foothold both when wet and dry;
- (b) where it covers a deck exposed to the weather, provide thermal insulation not less than that provided by a wooden deck 57 millimetres thick;
- (c) where it covers any other deck, provide a warm and comfortable surface;
- (d) be such that it will not readily ignite;
- (e) be such that after being immersed in water for 48 hours, its moisture content will not exceed 7 per cent of its dry weight;
- (f) not be such that it might be injurious to health;
- (g) be sufficiently hard and strong to withstand all reasonable conditions of service and sufficiently flexible not to crack in those conditions;
- (h) where laid in a permanent hospital, be such that it will not be readily susceptible to damage by liquids which are likely to be used in the hospital;
- (i) where it is laid directly on top of an oil tank, be such that if it is immersed in fuel oil for 24 hours at a temperature of 66° C it will not be penetrated by the oil and its weight will not increase by more than 1 per cent;
- (j) not contain any substance which may cause corrosion of the deck on which it is laid;
- (k) be fitted only to a deck which is protected from corrosion by a coating supplied for the purpose;
- (l) be fitted only by means of an adhesive or otherwise so as to affix it securely to the deck.

Regulation 9(1)(b).

**SECOND SCHEDULE  
INSULATING MATERIAL FOR THE UNDERSIDE  
OF DECKS**

1. The insulating material referred to in regulation 9(1)(b) shall—
  - (a) provide thermal insulation not less than that provided by a wooden deck 57 millimetres thick;
  - (b) be such that it is non-combustible, that is to say, insulating material which when heated to a temperature of 750°C (1,382°F) neither flames for longer than 10 seconds duration, nor raises either its internal temperature or the temperature of the test furnace more than 50°C (90°F) above 750°C (1,382°F) when tested in accordance with ISO-1190;
  - (c) not contain any substance which may cause corrosion of the deck on which it is laid;
  - (d) be fitted only to a deck which is protected from corrosion by a coating supplied for that purpose;
  - (e) be fitted by means of an adhesive or otherwise so as to affix it securely to the deck.

Regulation 15.

**THIRD SCHEDULE  
ELECTRIC LIGHTING**

Definition.

1. “General measurement points” means, in relation to any space, those points which measures at a height of 850 millimetres above the floor, fall on an imaginary line drawn vertically through the following points:

- (a) every point mid-way between every 2 adjacent lamps in that space;
- (b) every point mid-way between any lamp and any position on the boundary of that space to which that lamp is nearer than any other lamp; and
- (c) where any part of the space available for free movement is shielded from the direct rays of the lamp by a re-entrant angle formed in the boundary of that space, the central point of the space so shielded.

(1) Sleeping Rooms and Day Rooms shall be lit to the following specifications:

- (a) at general measurement points ... .. 50 lux;
- (b) at every mirror ... .. 200 lux;
- (c) at every seat at a writing desk or table ... .. 150 lux; and
- (d) at not less than half the seats [other than those mentioned in (3) above], in a sleeping room provided for use of more than one person ... 150 lux.

- (2) mess rooms shall be lit to the following specifications:
- (a) at general measurement points ... .. 100 lux; and
  - (b) at every table and sink ... .. 150 lux.
- (3) Recreation Rooms, including rooms for watching films and television, hobbies and games rooms shall be lit to the following specifications:
- (a) at general measurement points ... .. 50 lux;
  - (b) at every recreational table ... .. 100 lux;
  - (c) at every seat at a writing desk or table ... .. 150 lux; and
  - (d) at not less than half the seats other than those mentioned in (3) above ... .. 150 lux.
- (4) Hospital Wards shall be lit to the following specifications:
- (a) at general measurement point ... .. 50 lux;
  - (b) at any washbasin ... .. 100 lux; and
  - (c) at least one fixed lamp shall be installed in addition to the electric reading lamp required by regulation 15(5) to be provided at the head of each bed.
- (5) Offices and Studies shall be lit to the following specifications:
- (a) at general measurement points ... .. 100 lux; and
  - (b) at every seat at a writing desk or table ... .. 200 lux.
- (6) Sanitary Accommodation, including sanitary accommodation in hospitals shall be lit to the following specifications:
- (a) at general measurement points ... .. 100 lux; and
  - (b) at any mirror ... .. 200 lux.
- (7) Laundries shall be lit to the following specifications:
- (a) at general measurement points ... .. 100 lux, and
  - (b) Drying Rooms ... .. 50 lux,
- at the centre of the space.
- (8) Galleys including bakeries and pantries to the following specifications:
- (a) at working positions ... .. 300 lux; and
  - (b) the lights shall be so disposed as to ensure that food preparation tables, range tops, serving tables and washing up sinks receive the maximum amount of light.
- (9) Dry provision storerooms and cold storerooms shall be lit to the following specifications:
- (a) at general measurement points ... .. 100 lux; and
  - (b) the lights shall be so disposed as to ensure that shelves and cupboards receive the maximum amount of light.

**LAWS OF TRINIDAD AND TOBAGO**

MINISTRY OF THE ATTORNEY GENERAL AND LEGAL AFFAIRS

www.legalaffairs.gov.tt

760

**Chap. 50:10**

*Shipping*

**[Subsidiary]**

*Shipping (Crew Accommodation) Regulations*

(10) Passageways, companionways and covered deck recreation spaces shall be lit to the following specifications:

- (a) at general measurement points ... .. 50 lux; and
- (b) a light shall be placed—
  - (i) at the head of each stairway, ladder and hatchway; and
  - (ii) at or near the doors of lockers provided for oilskins or working clothes.

Regulation 16.

**FOURTH SCHEDULE**

**TRUNKED MECHANICAL VENTILATION SYSTEMS**

1. The trunked mechanical ventilation system referred to in regulation 16 (in this Schedule referred to as “the system”) shall, in relation to the spaces specified in the second column of Table I, be capable of the respective standards of performance specified in the third or fourth column of that Table, whichever standard shall be the higher in the circumstances. In this paragraph and in Table I, the term “spaces” excludes the spaces mentioned in Table II.

2. The system shall, in relation to the spaces specified in the second column of Table II, be capable of the respective standards of performance specified in the third and fourth columns of that Table.

3. A supply system shall be provided for the galley to provide the air changes required in Table II.

4. That supply system may serve the provision storerooms as well as the galley, but shall be separate from the supply system for any other spaces.

5. A separate exhaust system shall be provided for the galley to provide the air changes required in Table II.

6. Where any provision storeroom is served by a fan which provides warmed air for any other space, the storeroom shall be provided with ventilation trunking separate from that serving such other space.

7. The clean area of the exhaust openings provided in conjunction with the system shall be sufficient to ensure that the velocity of air at each exhaust opening does not exceed 305 metres per minute when the system is in operation.

8. The speed of every supply fan forming part of the system shall be capable of being varied where DC motors are used.

9. The system shall be quiet in operation.

UNOFFICIAL VERSION

UPDATED TO 31ST DECEMBER 2016

10. All trunking forming part of the system shall be fitted with non-return flaps where such flaps are necessary for the exclusion of effluvia and the preservation of health of the crew.

11. If the system is designed to circulate heated air as the sole means of heating the crew accommodation, the system shall be sub-divided into sections which can be separately controlled to the extent necessary to enable a comfortable temperature to be maintained in all parts of the crew accommodation.

12. The spare gear referred to in regulation 16(9) shall be—

- (a) Motors (for each size fitted) 1 set Bearings;
- (b) Starters (for each size fitted)—
  - (i) 1 set Contacts;
  - (ii) 1 set Springs; and
  - (iii) 1 set Operating Coil;
- (c) Mechanical Spares for Pump (for each size fitted)—
  - (i) 1 set Wearing Rings; and
  - (ii) 1 set Seal parts;
- (d) For Air-Conditioning Units—
  - (i) 1 set Air Filter Cells (if throw-away type fitted);
  - (ii) 1 set Fan Bearing for A/C Unit; and
  - (iii) 1 set Vee Belts for each size and type fitted;
- (e) For Refrigerating Machinery—
  - (i) Compressor (for each size fitted)—
    - (A) 1 Gasket Set;
    - (B) 1 Shaft Seal replacement;
    - (C) 1 set Piston Rings;
    - (D) 1 complete set Connecting Rod Bearings;
    - (E) 1 set Discharge Valve Discs; and
    - (F) 1 set Discharge Valve;
  - (ii) Springs—
    - (A) 1 set Suction Valve Discs;
    - (B) 1 set Suction Valve Springs;
    - (C) 1 Main Bearing—Pump End;
    - (D) 1 Main Bearing—Seal End;
    - (E) 2 Pump End Bearing Washers (Bronze);
    - (F) 2 Seal End Bearing Washers (Bronze);
    - (G) 2 Seal End Thrust Washers (Steel); and
    - (H) 1 Oil Filter;

**LAWS OF TRINIDAD AND TOBAGO**

MINISTRY OF THE ATTORNEY GENERAL AND LEGAL AFFAIRS

www.legalaffairs.gov.tt

762

**Chap. 50:10**

*Shipping*

**[Subsidiary]**

*Shipping (Crew Accommodation) Regulations*

- (iii) Condenser (for each size fitted)—
  - (A) 1 set End Cover Gaskets;
  - (B) 1 set Condenser Anodes; and
  - (C) 1 Tube Cleansing Brush;
- (iv) Miscellaneous—
  - (A) 1 Oil Differential Switch;
  - (B) 1 High/Low Pressure Switch;
  - (C) 1 set Drier Cores;
  - (D) 1 Relief Valve;
  - (E) 1 set Packing for Refrigerating Line Valves;
  - (F) 1 set Vee Belts of each size fitted;
  - (G) 1 Expansion Valve of each size fitted; and
  - (H) 1 Lead Detector.

13. TABLE I (not applicable to Spaces specified in Table II)

1	2	3	
Category	Spaces	Fresh air changes per hour	Volume of fresh air in cubic metres minutes, for each person likely to use the room at any one time
A	Accommodation above the Upper Deck		
	(i) rooms [other than those in category (ii)]		
	(1) outside rooms (other than rooms adjoining machinery casings)...	12	1.42
	(2) inside rooms and rooms adjoining machinery casings ...	15	1.42
	(ii) mess rooms, smoking rooms and recreation rooms		
	(1) not adjoining machinery casings ...	15	0.71(a)
	(2) adjoining machinery casings ... ..	18	0.71(a)

UNOFFICIAL VERSION

UPDATED TO 31ST DECEMBER 2016

1	2	3	
Category	Spaces	Fresh air changes per hour	Volume of fresh air in cubic metres minutes, for each person likely to use the room at any one time
B	Accommodation below the Upper Deck of Motor Vessels (i) rooms [other than those in category (ii)] (1) outside rooms (other than rooms adjoining machinery casings)... (2) inside rooms and rooms adjoining machinery casings ...	12  15	1.42  1.70
	(ii) mess rooms, smoking rooms and recreation rooms (1) not adjoining machinery casings ... (2) adjoining machinery casings ... ..	15  18	0.71  0.71
C	Accommodation below the Upper Deck of Steam Ships (i) rooms [other than those in category (ii)] (1) outside rooms (other than rooms immediately above or adjoining machinery casings) ... .. (2) inside rooms and rooms immediately above or adjoining machinery casings ...	12  18	1.42  1.70
	(ii) mess rooms, smoking rooms and recreation rooms (1) not adjoining machinery casings ... (2) adjoining machinery casings ... ..	18  20	0.85(b)  0.85(b)

**LAWS OF TRINIDAD AND TOBAGO**

MINISTRY OF THE ATTORNEY GENERAL AND LEGAL AFFAIRS

www.legalaffairs.gov.tt

764

**Chap. 50:10**

*Shipping*

**[Subsidiary]**

*Shipping (Crew Accommodation) Regulations*

13. TABLE I—*Continued*

1 Category	2 Spaces	3 Fresh air changes per hour	Volume of fresh air in cubic metres minutes, for each person likely to use the room at any one time
D	Passageways above and below the Upper Deck Adjoining machinery casings ... ..	4	—

- (a) whatever the number of persons likely to use the room at any one time, the total volume of fresh air per minute shall not be required to exceed such volume per minute as would produce 20 fresh air changes per hour;
- (b) whatever the number of persons likely to use the room at any one time, the total volume of fresh air per minute shall not be required to exceed such volume per minute as would produce 25 fresh air changes per hour.

14. TABLE II

1	2	3 Fresh air changes per hour	
Category	Spaces	Supply	Exhaust
E	Galleys	20(c)	40
F	Sanitary accommodation laundries drying rooms and pantries private or semi- private toilets	(d)  (d)	15  10

UNOFFICIAL VERSION

UPDATED TO 31ST DECEMBER 2016

14. TABLE II—*Continued*

1	2	3	
Category	Spaces	Supply	Exhaust
G	Wards in permanent hospitals	Fresh air changes per hour  12 or such greater number as would result in the supply of not less than 1.42 cubic metres fresh air per minute for each bed in the ward	—
H	Dry provisions storerooms	Not less than 10 and not more than (20) <sup>e</sup>	—

- (a) fifteen, if at least two sides of the galley are exposed to the weather;
- (b) mechanical supply ventilation may be fitted in addition to the mechanical exhaust ventilation provided that the volume of air supplied does not exceed that provided by the exhaust;
- (c) subject to the provisions of regulation 33(5).

Regulation 20.

**FIFTH SCHEDULE**

**MARKING**

**PART I**

**MARKING FOR SLEEPING ROOMS**

Certified for (\*) seamen

**PART II**

**MARKING FOR SPACES OTHER THAN  
SLEEPING ROOMS**

Certified for Chief Engineer (1)

Certified for Officers

Certified for Petty Officers

Certified for Cadets

Certified for Crew

---

\*There shall be inserted here the maximum number of seamen who may be accommodated in the room in accordance with these Regulations.

1. In the case of a room intended for the sole use of any other officer the rank of that officer shall be substituted here.

---

(Regulation 40).

**SIXTH SCHEDULE**

**CREW ACCOMMODATION REQUIREMENTS FOR  
EXISTING SHIPS**

Position of crew  
accommodation.

1. (1) In every ship to which this Schedule applies the crew accommodation, other than storerooms, shall be wholly situated above the Summer load line, if any, marked on the ship in accordance with the provisions of the regulations made under section 280 of the Act.

(2) In every ship to which this Schedule applies the crew accommodation, other than storerooms, shall be situated amidships or aft and in no case be situated forward of the collision bulkhead.

UNOFFICIAL VERSION

UPDATED TO 31ST DECEMBER 2016

(3) Sleeping rooms forming part of the crew accommodation of a passenger ship to which this Schedule applies shall not be situated immediately beneath a working passageway.

2. (1) In every ship to which this Schedule applies the height of the crew accommodation measured from the top of the floor beams to the top of the crown beams shall be not less than the following: Height of crew accommodation.

- (a) in ships of under 1,600 tons—7 feet; and
- (b) in ships of 1,600 tons or over—7 feet 6 inches.

(2) Every sleeping room forming part of the crew accommodation in a ship to which this Schedule applies shall be so constructed as to provide a clear headroom at least 6 feet 3 inches at every point in the room which is available for free movement.

3. (1) In every ship to which this Schedule applies all bulkheads enclosing or within any part of the crew accommodation shall be properly constructed of steel or other suitable material. Construction of bulkheads and panelling.

(2) Where the bulkheads are exposed to the weather they shall be of watertight and gastight construction, and means of closure shall be provided for all openings in such bulkheads so as to enable them to be made weathertight.

(3) Any bulkhead which separates any part of the crew accommodation, other than a recreation deck space, from a space used as—

- (a) a permanent coal bunker;
- (b) an oil fuel bunker;
- (c) a cargo or machinery space;
- (d) a lamp room or paint room;
- (e) a storeroom not forming part of the crew accommodation, other than a dry provision storeroom;
- (f) a chain locker; or
- (g) a cofferdam,

shall be gastight, and shall be watertight where necessary to protect the crew accommodation.

(4) Any bulkhead which separates any part of the crew accommodation from a dry provision storeroom, whether or not such storeroom forms part of the crew, accommodation shall be gastight.

(5) Subject to paragraph 24(11) of this Schedule any bulkhead which separates any part of the crew accommodation from sanitary accommodation or from a laundry or drying room, galley or cold storeroom, whether or not such sanitary accommodation, laundry, drying room, galley or

LAWS OF TRINIDAD AND TOBAGO

MINISTRY OF THE ATTORNEY GENERAL AND LEGAL AFFAIRS

www.legalaffairs.gov.tt

768

Chap. 50:10

Shipping

[Subsidiary]

Shipping (Crew Accommodation) Regulations

cold storeroom forms part of the crew accommodation, shall be gastight, and shall be watertight to such height as is necessary to prevent the passage of water into the adjoining space.

(6) In particular any bulkhead separating sanitary accommodation from any other part of the crew accommodation shall, except in a doorway, be watertight to a height of at least 9 inches above the floor of the sanitary accommodation.

(7) The requirements of this paragraph shall not apply to bulkheads separating—

- (a) sanitary accommodation from other sanitary accommodation;
- (b) a laundry or drying room from another laundry or drying room;
- (c) a galley from another galley or a pantry; or
- (d) a cold storeroom from another cold storeroom.

(8) Any inside panelling in the crew accommodation shall be constructed of plywood or other suitable material with a surface which can be easily kept clean.

(9) Neither bulkheads nor inside panelling shall be constructed with tongued and grooved boarding or in a manner or with material likely to harbour vermin.

Overhead decks.

4. (1) In every ship to which this Schedule applies, being a ship constructed of steel or other metal, every deck which forms the crown of any part of the crew accommodation (in this paragraph referred to as an “overhead deck”) and is exposed to the weather shall be constructed of steel or other metal.

(2) The upper side of every such deck shall be sheathed with wood or with a material which complies with the requirements specified in Appendix I to this Schedule

(3) Sheathing referred to in paragraph (2) shall be properly laid and, where it consists of wood, shall be properly caulked.

(4) Every wooden overhead deck shall be at least 2 ½ inches thick and every wooden sheathing shall be 2 ¼ inches thick.

Flooring.

5. (1) In every ship to which this Schedule applies the decks which form the floors in the crew accommodation shall be properly constructed and shall have a surface which provides a good foothold and is capable of being easily kept clean.

(2) The floor-covering shall be impervious to water and, where the deck is situated on the top of an oil tank, impervious to oil.

(3) Wooden decks which form the floors in the crew accommodation shall be at least 2 ½ inches thick and shall be properly laid and caulked.

(4) The surface of metal decks which form the floors of the crew accommodation, not being floors in sanitary accommodation, galleys,

UNOFFICIAL VERSION

UPDATED TO 31ST DECEMBER 2016

storerooms or laundries, shall be covered with linoleum or wooden planking, or with a material which complies with the requirements specified in Appendix I to this Schedule.

(5) The joinings of such material with the side walls shall be rounded in a manner which will avoid crevices.

(6) Such linoleum, planking or material shall be properly laid.

(7) The floors of sanitary accommodation, galleys and laundries in the crew accommodation shall be covered with terrazzo, tiles, or other hard material which is impervious to liquids.

(8) The floor-covering shall be properly laid and shall provide a good foothold.

(9) The joinings of the floors with the side walls shall be rounded in a manner which will avoid crevices.

6. (1) In every ship to which this Schedule applies the crew accommodation and the means of access thereto and egress therefrom shall be so arranged and constructed and situated in such a position as to ensure—

Protection from weather, etc.

- (a) the protection of the crew against injury to the greatest practicable extent;
- (b) the protection of the crew accommodation against the weather and the sea;
- (c) the insulation of the crew accommodation from heat and cold;
- (d) the protection of the crew accommodation against moisture due to condensation;
- (e) the exclusion from the crew accommodation of effluvia originating in other spaces in the ship; and
- (f) the exclusion from the crew accommodation, to the greatest practicable extent of noise originating in other spaces in the ship.

(2) Without prejudice to the generality of the foregoing paragraph—

- (a) every opening from an open deck into the crew accommodation shall be protected against the weather and the sea;
- (b) the crew accommodation shall be accessible at all times from the open deck;
- (c) access to sleeping rooms, mess rooms, recreation rooms and studies forming part of the crew accommodation shall be obtained from a passageway which shall be provided with a hinged door at any entrances from the open deck;
- (d) bow hawse pipes shall not be situated in the crew accommodation;
- (e) steam supply and exhaust pipes for steering gear, winches and similar equipment shall not pass through the crew accommodation;

- (f) all steam pipes, hot water pipes and calorifiers in or serving the crew accommodation shall be efficiently lagged wherever lagging is necessary for the conservation of heat or the protection of the crew against injury or discomfort;
- (g) all cold water pipes in the crew accommodation shall be efficiently lagged wherever lagging is necessary for the prevention of condensation;
- (h) chain pipes and ventilator trunks to cargo spaces or tanks, shall be made of steel or other suitable material and shall be gastight where they pass through any part of the crew accommodation;
- (i) batteries for the operation of the ship's radio installation, if any, shall not be placed in any sleeping room provided for the crew, and precautions shall be taken which will ensure that fumes from such batteries cannot discharge into any part of the crew accommodation;
- (j) the bulkheads and the parts of the ship's side which enclose the crew accommodation shall be insulated in a manner which will prevent overheating of the accommodation, and shall be covered with protective covering which will prevent the condensation of moisture;
- (k) every bulkhead, casing and deck separating the crew accommodation from other spaces in the ship in which heat or cold may be generated shall be insulated in a manner which will prevent the crew accommodation being so affected by such heat or cold or by condensation as to prejudice the health or comfort of the crew;
- (l) every ship for the time being regularly engaged on voyages to, within or through the Tropics or the Persian Gulf shall be provided with awnings which will cover—
  - (i) all exposed decks and house-tops situated immediately above any part of the crew accommodation;
  - (ii) all exposed sides of galleys situated on an open deck;
  - (iii) such portion of the deck spaces provided for the recreation of the crew in compliance with paragraphs 18(8) and 18(9) of this Schedule as will provide a shaded area adequate in extent having regard to the number of persons in the crew and to any shade provided for such spaces by overhanging decks;
- (m) the awnings shall be supported by stanchions or by other suitable means;

- (n) there shall be no direct opening between the crew accommodation, other than recreation deck spaces, and spaces used as—
  - (i) permanent coal bunkers;
  - (ii) oil fuel bunkers;
  - (iii) cargo or machinery spaces;
  - (iv) lamp rooms or paint rooms;
  - (v) storerooms not forming part of the crew accommodation, other than storerooms for engine room or deck department stores;
  - (vi) chain lockers;
  - (vii) cofferdams; or
  - (viii) a storeroom for engine room stores or deck department stores;
- (o) there may be a direct opening between machinery spaces and sanitary accommodation and changing rooms provided for the sole use of officers and ratings of the engine room department;
- (p) subject to paragraph 20(3), paragraph 24(13) and (14) and paragraph 28(31), (32), and (33) of this Schedule there shall be no direct opening between the crew accommodation, other than recreation deck spaces or passageways, and any sanitary accommodation, laundry or drying room, whether or not such sanitary accommodation, laundry or drying room forms part of the crew accommodation;
- (q) nothing in this subparagraph shall prohibit direct openings between spaces forming part of sanitary accommodation, or between spaces appropriated for use as laundries or drying rooms;
- (r) any part of the crew accommodation which is adjacent to any part, other than the crown, of a tank in which oil may be carried in bulk, shall be separated therefrom by a gastight steel division additional to the division which retains the oil;
- (s) where any part of the crew accommodation is situated on a deck which forms the crown of a space in which oil may be carried in bulk, such deck shall be oiltight;
- (t) no manholes or other openings to the oil tanks shall be situated in the crew accommodation;
- (u) where any part of the crew accommodation is situated on a deck forming the crown of a permanent coal-bunker, such deck shall be gastight;

LAWS OF TRINIDAD AND TOBAGO

MINISTRY OF THE ATTORNEY GENERAL AND LEGAL AFFAIRS

www.legalaffairs.gov.tt

772

Chap. 50:10

Shipping

[Subsidiary]

Shipping (Crew Accommodation) Regulations

- (v) the means of access to and egress from every part of the crew accommodation shall be so situated that in the event of fire in any lamp room or paint room in the ship, access to and egress from the crew accommodation will not be impeded.

Heating.

7. (1) In every ship to which this Schedule applies, other than a ship employed solely within the Tropics or the Persian Gulf—

- (a) all sleeping rooms;
- (b) mess rooms;
- (c) recreation rooms;
- (d) sanitary accommodation;
- (e) offices;
- (f) studies and hospitals forming part of the crew accommodation,

shall be provided with a heating system which shall be permanently installed and capable of ensuring that when the ventilation system provided for such rooms or accommodation in compliance with this Schedule is working so as to furnish at least 15 cubic feet of fresh air per minute for each person whom the room or accommodation is designed to accommodate at one time and the temperature of the open air is 30°F, the temperature therein can be maintained at 67°F.

(2) The temperature within a water closet shall not be required to be maintained at more than 10°F above the ambient temperature in the open air.

(3) Where the temperature within any water closet is capable of being so maintained by heat derived from an adjoining compartment, a heating system shall not be required to be provided in that water closet.

(4) The permanent heating system required by paragraph (1) shall be operated by steam, hot water or electricity, or shall be a system supplying warm air.

(5) The heating equipment shall be so constructed, installed and, necessary, shielded as to avoid the risk of fire and not to constitute a source of danger or discomfort to the crew.

(6) In particular means shall be provided, unless the provision thereof is unreasonable or impracticable in the circumstances, by which, without the use of a tool or key the heat emitted by the radiator or other heating device fitted in any space can be turned on and off and varied.

(7) The heating equipment shall be so constructed that its operation is not affected by the use or non-use of any steering-gear, deck machinery, calorifiers or cooking appliances in the ship.

(8) The heating system shall be in operation at all times when any members of the crew are living or working on board the ship and circumstances require its use.

UNOFFICIAL VERSION

UPDATED TO 31ST DECEMBER 2016

(9) While the ship is in port the heating system shall not be required to be in operation if efficient temporary means of heating are provided for such parts of the crew accommodation as are in use.

8. (1) In every ship to which this Schedule applies every part of the crew accommodation, other than pantries, laundries, drying rooms, lockers and storerooms shall be properly lighted by natural light. Lighting.

(2) Where in any space in a passenger steamer or in a ship engaged in the whaling industry it is impracticable to provide proper natural lighting, such lighting shall not be required where adequate electric lighting is always available in that space.

(3) The natural lighting of a sleeping room, mess room, recreation room or hospital ward shall be deemed to be proper for the purpose of this paragraph if it is sufficient to enable an ordinary newspaper to be read by a person of normal vision at any point in the room, being a point available for free movement, during daytime and in clear weather.

(4) Every sidescuttle in a sleeping room, mess room, smoking room or recreation room in the crew accommodation of a ship to which this Schedule applies shall be capable of being opened.

(5) This subparagraph shall not apply to any sidescuttle being a sidescuttle in a passenger ship which is required by regulations of any Shipping (Passenger Ship Construction) Regulations to be of a non-opening type.

(6) In every ship of 3,000 tons or over such sidescuttle shall be at least 12 inches in diameter.

(7) In every ship to which this Schedule applies an electrical system shall be installed which is capable of providing adequate lighting in every part of the crew accommodation.

(8) The electric lights shall be so arranged as to give the maximum benefit to the crew, and in particular an electric reading light shall be fitted at the head of each bed and shall be capable of being switched on and off from the bed.

(9) A lamp emitting at least 200 lumens shall be fitted in every such reading light in a sleeping room, and a lamp emitting at least 400 lumens shall be fitted in every such light in a hospital.

(10) An efficient alternative system of lighting or source of electric power shall be always available for lighting the crew accommodation.

(11) In addition to any other lights required by this Schedule the spaces referred to in subparagraphs 16 to 28 inclusive shall be provided with the lighting therein specified.

(12) The electric lighting of the spaces referred to in subparagraphs 16 to 28 inclusive shall be deemed to be adequate for the purposes of this Schedule

if, when the lamps and paintwork are new, the illumination in the horizontal plane when measured at the points and in the manner prescribed in subparagraph 13(c) is steady and subject to a tolerance of 10 per cent is maintained at a value not less than that prescribed for every such space.

(13) The points at which illumination shall be measured shall be as follows:

- (a) where general measurement points are prescribed for the illumination of a space then measurements shall be taken at every point midway between every 2 adjacent lamps and at every point midway between every lamp and any position on any boundary of the space;
- (b) where within any space a part of that space, being a part of that space available for free movement, is shaded from the direct rays of a lamp by a re-entrant angle formed in the boundary of the space, then the central point of the part of the space so shaded shall also be a general measurement point; and
- (c) where particular measurement points are also prescribed for a space, then measurements shall in addition be taken at every such point.

(14) In all cases measurements shall be taken at a height of 2 feet 9 inches above the floor, except that in the case of passageways, companionways, and covered recreation deck spaces, measurements may be taken either at a height of 2 feet 9 inches above the floor or at floor level, provided that in the case of measurements taken at floor level the reflection factor of the floor surface shall not be less than 40 per cent.

(15) Illumination of provision storerooms shall be measured when the rooms are empty.

(16) Sleeping rooms and day rooms shall contain the following:

- (a) 2 foot-candles immediately in front of any drawer, bookcase, clothes locker, wardrobe and toilet mirror;
- (b) 5 foot-candles at any washbasin; and
- (c) 6 foot-candles at any seat at a writing desk or table, and at not less than half the remaining seats in a sleeping room provided for the use of more than one person.

(17) For the purpose of paragraph (16) reading lights at the heads of beds shall not be taken into account in determining the illumination of a space except in the case of a sleeping room provided for the use of one person only.

(18) Mess rooms shall contain the following:

- (a) 2 foot-candles at general measurement points; and
- (b) 5 foot-candles at any table and sink.

- (19) Recreation and smoking rooms shall contain the following:
- (a) 2 foot-candles at general measurement points;
  - (b) 5 foot-candles at the recreation tables; and
  - (c) 6 foot-candles at any seat at a writing position at a desk or table and at not less than half the remaining seats.
- (20) Hospital wards shall contain the following:
- (a) 2 foot-candles at general measurement points;
  - (b) 5 foot-candles at any wash-basin; and
  - (c) in addition to the electric reading lamp required to be provided at the head of each bed in accordance with subparagraph (8), at least one fixed lamp shall be installed. The portable electric lamps required to be provided by paragraph 28(18) of this Schedule shall emit at least 600 lumens.
- (21) For the purposes of subparagraph (20) reading lights at the heads of beds shall not be taken into account in determining illumination except in the case of a hospital ward provided for the use of one person only.
- (22) Offices and studies shall contain the following:
- (a) 2 foot-candles immediately in front of any drawer and any bookcase; and
  - (b) 8 foot-candles at every writing position at a desk or table.
- (23) Sanitary accommodation including in hospitals shall contain the following:
- (a) water closets 3 foot-candles in way of the pan;
  - (b) shower spaces 2 foot-candles in the centre of the space;
  - (c) wash rooms and bathrooms;
  - (d) 3 foot-candles at general measurement points;
  - (e) 5 foot-candles at any washbasin or washing trough and at or near the head of any bath.
- (24) Laundries shall contain the following:
- (a) 3 foot-candles at general measurement points; and
  - (b) 5 foot-candles at any washing trough.
- (25) Drying rooms shall contain—
- 2 foot-candles in the centre of the space.
- (26) Galleys, including bakeries and pantries shall contain the following:
- (a) 6 foot-candles at working positions; and
  - (b) lamps that shall be so disposed as to ensure that food preparation tables, range top, serving tables and washing-up sinks receive the maximum amount of light.

LAWS OF TRINIDAD AND TOBAGO

MINISTRY OF THE ATTORNEY GENERAL AND LEGAL AFFAIRS

www.legalaffairs.gov.tt

776

Chap. 50:10

Shipping

[Subsidiary]

Shipping (Crew Accommodation) Regulations

(27) Provision storerooms shall contain the following:

- (a) Dry Storerooms;
- (b) 2 foot-candles at general measurement points;
- (c) 2 foot-candles immediately in front of shelving and any cupboard; and
- (d) cold storerooms of half the standard prescribed for a dry storeroom.

(28) Passageways, companionways and cover recreation deck spaces shall contain the following:

- (a) 2 foot-candles at general measurement points; and
- (b) a lamp shall be placed at or near the head of each stairway or ladder or hatchway and at or near doors of any lockers provided for oilskins or working clothes.

Ventilation.

9. (1) In every ship to which this Schedule applies the enclosed parts of the crew accommodation shall be ventilated by a system which will maintain the air therein in a state of purity adequate for the health and comfort of the crew.

(2) Such system shall be capable of being so controlled as to ensure a sufficiency of air movement under all conditions of weather and climate to which the ship is likely to be subject during the voyages on which she is intended to be engaged, and shall be additional to any sidescuttles, skylights, companions, doors or other apertures not intended solely for ventilation.

(3) Every enclosed space forming part of the crew accommodation of a ship to which this Schedule applies, being a space not ventilated by a trunked mechanical ventilation system, shall be provided with a natural system of inlet and exhaust ventilation.

(4) Every inlet ventilator forming part of such system, being a ventilator situated in the open air, shall be of a cowl or other equally efficient type and shall be so situated that, as far as is practicable, it is not screened from the wind in any direction.

(5) No such ventilator shall be situated directly over a doorway, stairway or exhaust opening.

(6) The sectional area of every part of the inlet and exhaust system, other than a part serving only a drying room or locker, shall be at least 6 square inches for each person for whose use at any one time the space is appropriate, and shall not be less than 19 square inches in all at any point in the system.

(7) The effective area of the inlet and exhaust system serving each space shall be capable of being adjusted from fully open down to a minimum of 3 square inches for each person likely to use the space at any one time.

UNOFFICIAL VERSION

UPDATED TO 31ST DECEMBER 2016

(8) Every enclosed space, other than a cold storeroom, forming part of the crew accommodation of a ship to which this Schedule applies, being a ship of 3,000 tons or over for the time being regularly employed otherwise than as a home trade ship, or a ship of under 3,000 tons for the time being regularly engaged only on voyages confined to the area within the Tropics and the Persian Gulf, shall be provided with a trunked mechanical ventilation system complying with the requirements specified in Appendix 2 to this Schedule.

(9) Such a system shall not be required in any galley which is situated on an open deck and exposed to the weather on the fore-end and the port and starboard sides.

(10) In the crew accommodation of every ship to which this Schedule applies, being a ship not provided with a trunked mechanical ventilation system, and not being a ship for the time being regularly engaged only on voyages as a Caribbean Trade Ship or on the coasts of New Zealand or at latitudes north of 53° North latitude or south of 45° South latitude, an electric fan shall be fitted in every sleeping room, mess room, recreation room, study, office, galley and pantry.

(11) Power for the operation of the trunked mechanical ventilation system or fans, as the case may be, required by the foregoing paragraphs shall be available at all times when any members of the crew are on board the ship and circumstances require such system or fans to be used.

(12) The following spare gear shall be provided for each size of electric motor employed to operate a trunked mechanical ventilation system in the crew accommodation of a ship to which this Schedule applies:

(a) for direct current motors—

- (i) 1 armature;
- (ii) 1 field coil;
- (iii) 1 set of bearings;
- (iv) 1 set of carbon brushes;
- (v) 1 brush holder;

(b) for alternating current motors—

- (i) 1 set of stator windings, complete with insulation pieces; and
- (ii) set of bearings;

(c) the spare gear shall be properly packed for storage.

10. (1) In every ship to which this Schedule applies efficient drainage by pipes or channels shall be provided for every part of the crew accommodation situated on an open deck wherever such drainage is necessary for clearing water shipped from the sea. Drainage.

**LAWS OF TRINIDAD AND TOBAGO**

MINISTRY OF THE ATTORNEY GENERAL AND LEGAL AFFAIRS

www.legalaffairs.gov.tt

778

**Chap. 50:10**

*Shipping*

**[Subsidiary]**

*Shipping (Crew Accommodation) Regulations*

(2) There shall be no drainage from any source, not being sanitary accommodation, into the sanitary accommodation forming part of the crew accommodation.

(3) Every space appropriated for use as sanitary accommodation shall be served by one or more scuppers which do not serve any space other than sanitary accommodation.

(4) The scuppers shall be at least 2 inches in diameter and shall be situated wherever water is likely to collect on the floor of the space.

(5) No scupper shall be required in washing accommodation appropriated for the sole use of one person.

Painting, etc.

11. (1) In every ship to which this Schedule applies the interior sides and ceilings of every part of the crew accommodation shall be covered with enamel, paint or other suitable material.

(2) The paint, enamel or other material shall be of good quality and white or light in colour.

(3) Lime wash or paint containing nitro-cellulose shall not be applied in the crew accommodation.

(4) The wooden part of the furniture and fittings in the crew accommodation shall be finished externally with paint, varnish, polish or by other suitable means.

(5) All paint, varnish, polish and other finishes in the crew accommodation shall be capable of being easily kept clean and shall be maintained in good condition.

Marking.

12. (1) Every sleeping room forming part of the crew accommodation of a ship to which this Schedule applies shall be marked inside the room with whichever of the markings specified in Part I of Appendix 3 to this Schedule is appropriate in the circumstances.

(2) Every space, other than a sleeping room or an open deck, forming part of the crew accommodation of such a ship shall be marked either inside the space or on or over the door to such space with whichever of the markings specified in Part II of Appendix 3 to this Schedule is appropriate in the circumstances.

(3) All markings required by the foregoing provisions of this paragraph shall be in clear characters and in a readily visible position on the ship's structure.

(4) The markings shall be cut into the structure or otherwise marked in an equally permanent manner.

(5) No space forming part of the crew accommodation of a ship to which this Schedule applies shall be marked, whether inside or outside the space, with any marking which may be taken to indicate that the space is appropriated for use by persons differing in number or description from the persons for whose use the space has been certified by a surveyor of ships.

UNOFFICIAL VERSION

UPDATED TO 31ST DECEMBER 2016

13. (1) In every ship to which this Schedule applies, unless the circumstances are such that no members of the crew are required to sleep on board, sleeping rooms shall be provided for the crew in accordance with the following provisions of this paragraph. Sleeping rooms.

(2) Separate and appropriate sleeping rooms shall be provided wherever required by the widely different national habits and customs of groups of persons in the crew.

(3) Each of the following classes of persons shall be provided with sleeping rooms separate from those provided for the other classes:

- (a) officers;
- (b) petty officers;
- (c) apprentices;
- (d) ratings of the deck department, other than petty officers;
- (e) ratings of the engine room department, other than petty officers; and
- (f) ratings of the catering department, other than petty officers.

(4) Every watch of ratings shall be provided with sleeping rooms separate from those of other watches.

(5) Day-men shall be provided with sleeping rooms separate from those of watch-keepers.

(6) The maximum number of persons accommodated in sleeping rooms shall be as follows:

- (a) in the case of officers in charge of a department, navigating and engineer officers in charge of a watch, and first or only radio officers there shall be 1 per room;
- (b) other officers—wherever practicable 1 person per room, and in no event more than 2 persons per room;
- (c) apprentices—wherever practicable not more than 3 persons per room, and in no event more than 4 persons per room;
- (d) chief or only steward and chief or only cook, in either case in a ship of 3,000 tons or over regularly employed otherwise than as a Caribbean trade ship—1 person per room;
- (e) petty officers not being persons referred to in subparagraph (d)—wherever practicable 1 person per room and in no event more than 2 persons per room;
- (f) other ratings—wherever practicable 2 or 3 persons per room, and in no event more than 4 persons per room.

LAWS OF TRINIDAD AND TOBAGO

(7) Subject to the provisions of subparagraphs (8) and (9) the minimum floor area provided for each person in a sleeping room forming part of the crew accommodation of a ship to which this Schedule applies shall be as follows:

Square feet

- (a) In ships of under 400 tons ... .. 15
- (b) In ships of 400 tons or over but under 800 tons ... 20
- (c) In ships of 800 tons or over but under 3,000 tons... 25
- (d) in ships of 3,000 tons or over ... .. 30

(8) Subject to the provisions of subparagraph (9), the minimum floor area provided in a sleeping room in a passenger ship shall be 24 square feet per person where more than 4 ratings are accommodated in that room.

(9) Subject to the provisions of this subparagraph the minimum floor area provided for each person in sleeping room for special ratings shall be as follows:

Square feet

- (a) In ships of under 400 tons ... .. 14
- (b) In ships of 400 tons or over but under 3,000 tons ... 18
- (c) In ships of 3,000 tons or over ... .. 20

(10) The total floor area of the sleeping rooms provided in the ship for special ratings shall not be less than would be required under subparagraph (7) to be provided for such number of rating as would be necessary in substitution for the special ratings if the special ratings were replaced by other ratings.

(11) In determining the floor area of a room for the purpose of this paragraph spaces occupied by berths, lockers, seats or chests of drawers shall be taken into account and spaces which by reason of their small size or irregular shape cannot accommodate furniture and do not contribute to the area available for free movement shall not be taken into account.

(12) The sleeping room required by subparagraph (6)(a) to be provided for the First or only Radio Officer shall be situated as near as practicable to the radiotelegraph room.

(13) The said sleeping room shall not be the radiotelegraph room.

Beds.

14. (1) Every sleeping room in the crew accommodation of a ship to which this Schedule applies shall be fitted with a bed for each person accommodated in the room.

(2) The framework of each bed, and the lee boards or lee rails thereof, if any, shall—

- (a) be constructed of metal or other material which is hard and smooth and unlikely to become corroded;
- (b) the framework shall be so made as not to be likely to harbour vermin; and
- (c) where the bed is constructed with tubular frames, the frames shall be completely sealed and without perforations.

(3) There shall be unobstructed access to at least one side of each bed and in particular, where the adjacent sides of two beds in the same room are parallel to each other or when projected make an angle of less than 90° with each other, the distance between those sides at any point shall not be less than 2 feet 6 inches if both beds are in single tier or 3 feet in any other case.

(4) Where beds abut upon each other they shall be separated by screens, made of wood or other suitable material.

(5) No bed shall be placed—

- (a) within 4 inches of a ventilation trunk which may be used for circulating hot air; or
- (b) within 2 inches of a bulkhead or the ship's side, unless the bed is so supported and the room so constructed as to avoid harbouring dirt and vermin in or near the bed, to enable the bedding to be kept clean and dry, and to minimise the soiling of paintwork in way of the bed.

(6) Beds shall not be arranged in tiers of more than two.

(7) Beds placed along the ship's side shall be singled tier, except in a room in which there is no sidescuttle.

(8) No bed shall be less than 1 foot from the floor of the room measured from the bottom of the mattress referred to in paragraph (10) below.

(9) The upper bed in a double tier shall be at least 2 feet 6 inches below the lower side of the deck head beams or other obstructions measured from the bottom of the mattress.

(10) The bottom of the mattress in the lower bed shall be at least 3 feet below the bottom of the mattress in the upper bed if the height of the sleeping room is 7 feet 6 inches or more, and at least 2 feet 9 inches below the bottom of the mattress in the upper bed if the height of the sleeping room is less than 7 feet 6 inches.

(11) For the purposes of this subparagraphs the height of the room shall be measured from the top of the floor beams to the top of the crown beams.

LAWS OF TRINIDAD AND TOBAGO

MINISTRY OF THE ATTORNEY GENERAL AND LEGAL AFFAIRS

www.legalaffairs.gov.tt

782

Chap. 50:10

Shipping

[Subsidiary]

Shipping (Crew Accommodation) Regulations

(12) Subject to the provisions of subparagraphs (9), (10) and (11) of this paragraph the size of the beds provided for the crew shall be at least 6 feet 3 inches by 2 feet 3 inches, the measurements being taken inside the lee boards, or lee rails, if any, and at right angles to each other.

(13) The size of the beds provided in a ship of 3,000 tons or over for the Chief Officer and for the Chief and Second Engineers shall be at least 6 feet 3 inches by 2 feet 9 inches in a passenger ship and at least 6 feet 3 inches by 3 feet 6 inches in any other ship, the measurements in each case being taken inside the lee board or lee rails, if any, and at right angles to each other.

(14) Every bed provided for a member of the crew shall be fitted with a spring bottom or spring under-mattress, and with a mattress made of material which will resist damp and is unlikely to harbour vermin.

(15) A bottom of wood, canvas or other dust-proof material shall be fitted to every bed which is fitted above another bed.

Furniture  
and fittings in  
sleeping rooms.

15. (1) In every ship to which this Schedule applies every sleeping room for ratings other than petty officers shall be provided with the following equipment:

- (a) for each person accommodated in the room—
  - (i) one drawer having a capacity of at least 2 cubic feet;
  - (ii) one clothes locker or wardrobe, in either case at least 5 feet 6 inches in height and 315 square inches in internal sectional area fitted with a shelf not less than 9 inches and not more than 15 inches below its top and with fittings on which clothes may be hung; and
  - (iii) at least one coat hook in addition to any coat hooks fitted in a locker or wardrobe;
- (b) a table of fixed or drop-leaf type, or a desk, or a sliding leaf or top fitted to a chest of drawers;
- (c) comfortable seats sufficient to accommodate at one time all the persons accommodated in the room;
- (d) such seats shall be provided in addition to the beds in the room;
- (e) a mirror suitable for toilet purposes;
- (f) a cabinet suitable for containing toilet requisites;
- (g) a book rack;
- (h) a runner of jute, coir or other suitable material at one side of each bed or tier or beds, as the case may be;
- (i) a curtain fitted to each bed, unless the room accommodates only one person; and
- (j) a curtain fitted to each sidescuttle, unless the sidescuttle is fitted with blinds or jalousies.

UNOFFICIAL VERSION

UPDATED TO 31ST DECEMBER 2016

(2) Paragraph 1 shall apply to sleeping rooms for petty officers as it applies to sleeping rooms for other ratings, subject to the following modifications and additions:

- (a) for each person accommodated in the room a second drawer having a capacity of at least 2 cubic feet shall be provided in addition to the drawer referred to in subparagraph(1)(a)(i);
- (b) the clothes lockers or wardrobes provided shall be made of hardwood;
- (c) each room shall be provided with—
  - (i) a rack suitable for holding—
    - (A) one drinking-water bottle; and
    - (B) one tumbler for each person accommodated in the room;
- (d) the rack may be fitted inside the cabinet for toilet requisites;
- (e) a rack for holding a drinking-water bottle shall not be required in any room in which a supply of drinking-water is laid on;
- (f) a washbasin, of vitreous china or other equally hygienic and durable material, which shall be fitted with an efficient and hygienic discharge overside or to an enclosed tank with a suction pipe served by a mechanically operated pump; and
- (g) a washbasin shall not be required to be fitted in a sleeping room for petty officers if washing accommodation is readily accessible from the sleeping room.

(3) In every sleeping room in which one or more than one petty officer or other rating is accommodated, every drawer, locker and wardrobe shall be fitted with a secure lock or hasp for a padlock.

(4) Subject to paragraph 5 every sleeping room for officers shall be provided with the following equipment:

- (a) for each officer accommodated in the room—
  - (i) at least three drawers with a total capacity of 10 cubic feet or as near thereto as is practicable in the circumstances;
  - (ii) a wardrobe at least 5 feet 6 inches in height and 460 square inches in internal sectional area; and
  - (iii) at least two coat hooks, in addition to any coat hooks fitted in the wardrobe;
- (b) a writing desk fitted, if practicable, with drawers additional to the aforesaid drawers;
- (c) a chair with arm rests;
- (d) a settee at least 6 feet in length or as near thereto as is practicable in the circumstances;

- (e) a mirror suitable for toilet purposes;
- (f) a cabinet suitable for containing toilet requisites;
- (g) a rack suitable for holding—
  - (i) one drinking-water bottle; and
  - (ii) one tumbler for each officer accommodated in the room;
- (h) the rack may be fitted inside the cabinet for toilet requisites;
- (i) a rack for holding a drinking-water bottle shall not be required in any room in which a supply of drinking-water is laid on;
- (j) a washbasin of vitreous china or other equally hygienic and durable material, which shall be fitted with an efficient and hygienic discharge overside or to an enclosed tank with a suction pipe served by a mechanical operated pump;
- (k) a washbasin shall not be required to be fitted in a sleeping room if washing accommodation is readily accessible therefrom;
- (l) a splash plate or other means of protection for the wall above the washbasin, if any;
- (m) a carpet runner of wool or similar material;
- (n) curtains fitted to each bed, unless the room accommodates only one officer;
- (o) curtains fitted to each sidescuttle, unless the sidescuttle is fitted with blinds or jalousies;
- (p) a book case in any room which accommodates a Chief Officer, Chief Engineer or Second Engineer, or in the case of a passenger ship a First Radio officer; and
- (q) a book case or book rack in rooms which accommodate other officers.

(5) Any of the equipment referred to in subparagraph (4)(b), (c), (d), (p) and (q) may be provided in a day room available for the sole use of the officers concerned, instead of in their sleeping room.

(6) Any of the equipment referred to in subparagraph (4)(e) to (l) inclusive may be provided in washing accommodation appropriated for the exclusive use of one officer instead of in the sleeping room of that officer.

(7) Sleeping rooms for apprentices shall so far as is reasonable and practicable in the circumstances be provided with the equipment, other than a book case, referred to in subparagraph (4), save that any of the equipment referred to in subparagraph (4)(b), (c) and (d) may be provided in a study for the sole use of the apprentices instead of in their sleeping rooms.

(8) Subject to subparagraphs (1) to (7), all lockers, wardrobes, tables, desks, the un-upholstered parts of chairs and settees and similar furnishings

provided in compliance with this paragraph shall be made of polished hardwood, rustproof metal or other smooth and impervious material not likely to crack, warp or become corroded.

(9) All furniture provided in sleeping rooms shall be so made as not to be likely to harbour vermin.

16. (1) In every ship to which this Schedule applies, unless the circumstances are such that no members of the crew are required to mess on board, mess rooms shall be provided for the crew and shall be of such dimensions as will be sufficient to accommodate the greatest number of persons likely to use them at any one time. Mess rooms.

(2) Separate and appropriate mess rooms shall be provided wherever required by the widely different national habits and customs of groups of persons in the crew.

(3) No mess room shall be combined with a sleeping room.

(4) In every ship of 500 tons or over the mess rooms provided for ratings shall be separate from those provided for the master of the ship or for officers.

(5) In every ship of 1,000 tons or over a single mess room shall be provided for all officers in the ship.

(6) The officers may be accommodated in separate mess rooms if their sleeping rooms are in widely separated portions of the ship.

(7) In every ship of 1,000 tons or over each of the following classes of ratings shall be provided with mess rooms separate from those provided for the other classes:

- (a) petty officers of the deck department;
- (b) petty officers of the engine room department;
- (c) other ratings of the deck department; and
- (d) other ratings of the engine room department.

(8) In every ship of 3,000 tons or over, being either—

- (a) a ship other than a Caribbean trade ship; or
- (b) a Caribbean trade ship with a catering department of more than 5 persons, mess rooms shall be provided for ratings of the catering department which shall be separate from those provided for ratings of other departments.

(9) Where in any other ship a separate mess room is not provided for ratings of the catering department, mess accommodation shall be provided for them in mess rooms provided for other ratings.

LAWS OF TRINIDAD AND TOBAGO

MINISTRY OF THE ATTORNEY GENERAL AND LEGAL AFFAIRS

www.legalaffairs.gov.tt

786

Chap. 50:10

Shipping

[Subsidiary]

Shipping (Crew Accommodation) Regulations

Furniture  
and fittings  
in mess  
rooms.

(10) Apprentices shall be provided with a separate mess room, or with messing accommodation in the officers' mess room.

17. (1) Every mess room forming part of the crew accommodation in a ship to which this Schedule applies shall be provided with sufficient tables to allow a space of at least 20 inches measured along the edge of a table, for each person likely to use the room at any one time.

(2) Each table shall be at least 24 inches wide if seats are provided on both sides of the table, and at least 15 inches wide if seats are provided only on one side of the table.

(3) The table shall be of such a size and so situated as to be readily accessible.

(4) Single chairs shall be provided in the mess room for each person using the room at any one time.

(5) Such chairs shall be fitted with arm rests unless chairs with arm rests are available in a recreational room for the persons using the mess room.

(6) Settees may be substituted for chairs adjacent to a bulkhead or the ship's side.

(7) Such settees shall be at least 15 inches wide and shall be fitted with upholstered or padded seats covered with material impervious to dirt and moisture, and shall be provided with comfortably shaped backs.

(8) If the mess room is appropriated for use by officers or petty officers, whether or not together with other ratings, the backs of the settees shall also be padded or upholstered and shall be covered with material impervious to dirt and moisture.

(9) Every mess room provided for persons who do not provide their own food shall be fitted with either—

(a) a storage locker or rack in either case capable of holding sufficient mess utensils for those persons; or

(b) a storage locker at least 15 inches by 15 inches by 12 inches in size for each of those persons.

(10) Every mess room provided for persons who provide their own food shall be fitted with a storage locker for each person which shall be of sufficient size to be capable of containing his mess utensils together with a supply of food sufficient for him for at least 7 days.

(11) All storage lockers provided in compliance with this paragraph shall be adequately ventilated, and all storage lockers provided for one person shall be fitted with a lock or hasp for a padlock, and shall be so fixed as to clear the floor by at least 1 foot.

UNOFFICIAL VERSION

UPDATED TO 31ST DECEMBER 2016

(12) The lockers or racks may be fitted in a pantry, storeroom or other suitable place outside a mess room and readily accessible therefrom.

(13) No lockers or racks, being lockers or racks intended to contain food, shall be fitted in a sleeping room, not being a sleeping room combined with a mess room.

(14) A dresser, hot-press, sink and boiler or other means from which boiling drinking water shall always be available shall be fitted in each mess room, unless such equipment is fitted in a pantry readily accessible from the room or, in the case of a ship of under 1,000 tons, in a galley.

(15) Such equipment shall be adequate in size for the number of persons likely to use the room at any one time.

(16) Where in the case of a mess room provided for officers or petty officers the dresser is fitted in a pantry, a sideboard shall be provided in the mess room.

(17) A supply of fresh water shall be laid on to the sink and boiler.

(18) All tables, lockers, dressers and the un-upholstered parts of chairs and settees in the mess room shall be made of polished hardwood, rustproof metal or other smooth and impervious material not likely to crack, warp or become corroded.

(19) All furniture provided in the mess room shall be so made as not to be likely to harbour vermin.

18. (1) In every ship to which this Schedule applies, being a ship of 3,000 tons or over employed otherwise than as a Caribbean trade ship, a smoking room shall be provided for the recreation of the officers, and shall not be combined with a mess room.

Recreation spaces and studies.

(2) The smoking room shall be provided with tables each having a top approximately 4 square feet in area and with tub chairs or easy chairs sufficient to accommodate at one time at least one-third of the number of officers for whose use the room is provided, and a book case.

(3) In every ship to which this Schedule applies, being a Caribbean trade ship of 300 tons or over or a ship of under 3,000 tons regularly employed otherwise than as a Caribbean trade ship, the mess room provided for the officers shall be available and furnished for use as a smoking room, unless a separate smoking room is provided for their use.

(4) In every ship to which this Schedule applies recreation accommodation shall be provided in a mess room or elsewhere for ratings and shall be conveniently situated and appropriately furnished.

**LAWS OF TRINIDAD AND TOBAGO**

MINISTRY OF THE ATTORNEY GENERAL AND LEGAL AFFAIRS

www.legalaffairs.gov.tt

788

**Chap. 50:10**

*Shipping*

**[Subsidiary]**

*Shipping (Crew Accommodation) Regulations*

(5) Where such accommodation is provided elsewhere than in a mess room the seating provided shall be sufficient to accommodate at one time at least one-third of the number of ratings for whom that accommodation is provided.

(6) Where more than two apprentices are accommodated in one sleeping room in a ship to which this Schedule applies, a separate room shall be provided in the ship for their use as a study, unless another suitable place is available to them for purposes of study.

(7) In every ship to which this Schedule applies, being a ship 500 tons or over, a bookcase shall be provided for, and shall be accessible to, all members of the crew.

(8) In every ship to which this Schedule applies space shall be provided on an open deck for the use of the crew for recreational purposes.

(9) The space shall be adequate in area, in so far as the size of the ship allows, having regard to the number of persons in the crew.

(10) Separate and appropriate recreation rooms shall be provided wherever required by the widely different national habits and customs of groups of persons in the crew.

Office accommodation.

19. (1) In every ship to which this Schedule applies, being a ship of 3,000 tons or over, and not being a ship used in treating whales or engaged in the carriage of persons employed in catching or treating whales, two separate rooms shall be provided for use as offices and shall be appropriately furnished for that purpose.

(2) One of such rooms shall be appropriated for use by the Chief Officer or the officers of the deck department, and the other for use by the Chief Engineer or for the officers of the engine room department.

(3) The office accommodation shall be in a room not used for any other purpose except study.

(4) An office appropriated solely for use by an individual officer may be combined with the day room of that officer.

Washing accommodation.

20. (1) In every ship to which this Schedule applies each of the following classes of persons shall be provided with washing accommodation separate from that provided for the other classes:

(a) officers and apprentices;

(b) petty officers; and

(c) ratings other than petty officers.

(2) The washing accommodation shall be situated close to the sleeping accommodation of the persons for whose use it is appropriated.

UNOFFICIAL VERSION

UPDATED TO 31ST DECEMBER 2016

(3) Part of the washing accommodation for ratings of the engine room department may be adjacent to the engine room and stokehold.

(4) Access to washing accommodation shall not be directly obtained from a mess room or a sleeping room and shall wherever reasonable and practicable in the circumstances be obtained from a passageway.

(5) Access to washing accommodation may be obtained directly from not more than 2 sleeping rooms accommodating not more than 4 persons in all, if the washing accommodation is appropriated for use solely by the person or persons accommodated in those sleeping rooms.

(6) The following equipment shall be provided in the washing accommodation for each class of persons referred to in subparagraph (1):

- (a) one bath or shower for every 8 persons;
- (b) one wash-basin for every 6 persons; and
- (c) one mirror suitable for toilet purposes for every 6 persons,

and each of such classes shall be provided with at least one bath or shower and at least one washbasin.

(7) One additional bath or shower shall be provided for any of such classes in which the total number of persons exceeds by 4 or more a multiple of 8, and one additional washbasin shall be provided for any of such classes in which the number of persons exceeds by 3 or more a multiple of 6.

(8) For the purposes of subparagraphs (6) and (7)—

- (a) a bath and shower combined shall be deemed to be only a bath;
- (b) no account shall be taken, in determining the number of baths and showers required, of—
  - (i) any private bath or shower; or
  - (ii) the persons for whose use a private washbasin is appropriated for the exclusive use of not more than four persons.

(9) The washbasins shall be made of vitreous china or other material having a smooth and impervious surface not likely to crack, flake or become corroded.

(10) Every washbasin provided in a passenger steamer, being a basin fitted with hot and cold fresh-water taps, shall have a capacity of at least 1 gallon.

(11) Every other washbasin provided in compliance with this Schedule shall have a capacity of at least 1½ gallons.

(12) The capacity of washbasins shall be measured for the purposes of this paragraph to a level at least 1½ inches below the rim of the bowl.

(13) Every bath shall be at least 4 feet 5 inches in internal length unless it is combined with a shower.

**LAWS OF TRINIDAD AND TOBAGO**

MINISTRY OF THE ATTORNEY GENERAL AND LEGAL AFFAIRS

www.legalaffairs.gov.tt

790

**Chap. 50:10**

*Shipping*

**[Subsidiary]**

*Shipping (Crew Accommodation) Regulations*

(14) Every bath shall be made of vitreous enamelled iron, or other material having a smooth and impervious surface not likely to crack, flake or become corroded.

(15) The floor area of every shower space shall be at least  $6\frac{1}{4}$  square feet, and each side of the space shall be at least 2 feet 6 inches long.

(16) Bath and showers provided for any class of persons shall be situated in or adjacent to a room containing washbasins and provided for that class of persons.

(17) Screening shall be provided to ensure privacy for any bath or shower which is in the same room as any washbasin or any other bath or shower unless the room is appropriated for the sole use of one person.

(18) The screening shall be made of robust and opaque material and shall be rigid on at least three sides of every bath and shower space.

(19) The screening shall, wherever reasonable and practicable in the circumstances, enclose sufficient space to permit a person to dress and undress in comfort therein.

(20) Every washbasin, bath and shower shall be fitted with an efficient and hygienic discharge system and in particular the waste pipes shall be fitted in a manner which will minimise the risk of obstruction and facilitate cleaning.

(21) Every shower space shall be provided with a handrail, a kerb and individual drainage.

(22) Every bath and shower space shall be provided with a grating or mat.

(23) Spring-loaded draw-off taps for hot and cold fresh water shall be fitted on a wall in every wash room provided for ratings, unless taps for hot and cold fresh water are fitted to each washbasin in that room.

(24) Draw-off taps for cold salt water shall be fitted in every such washroom, unless there are other adequate means of washing down the room.

(25) Nothing in this paragraph shall apply to the washing accommodation forming part of a permanent hospital, and for the purposes of subparagraph (6) thereof no account shall be taken of any washbasin, bath or shower fitted in a permanent hospital.

Supply of water to washing accommodation.

21. (1) In every ship to which this Schedule applies there shall be available a supply of fresh water sufficient for the washbasins, baths and showers fitted in compliance with this Schedule.

(2) The supply shall be provided from tanks of a capacity of at least 10 replenishments of the water or by other equally efficient means.

UNOFFICIAL VERSION

UPDATED TO 31ST DECEMBER 2016

(3) Where service tanks are fitted for that purpose they shall be directly connected with the ship's main washing water or drinking water storage tanks.

(4) In ships of 1,000 tons or over any pumping necessary for the supply of fresh water shall be by mechanical power.

(5) Hot and cold fresh water shall be laid on to all washbasins, baths and showers fitted in compliance with this Schedule subject to the following conditions:

- (a) in the case of a bath and shower combined, hot and cold fresh water shall be required to be laid on only to the bath or the shower; and
- (b) hot and cold fresh water shall not be required to be laid on to washbasins provided for the sole use of ratings if it is laid on to spring-loaded draw-off taps in the same room in accordance with paragraph 20(23) of this Schedule.

(6) Cold fresh water shall be laid on to any washbasins which are additional to those required by this Schedule and are fitted in sleeping rooms.

(7) The hot fresh water shall be at a constant temperature of at least 150°F and shall be supplied by thermostatically controlled calorifiers or by other equally safe and efficient means.

(8) Every shower bath shall be provided with an antiscalding mixing valve which shall be adjusted so that the temperature of the shower-waters, whether salt or fresh, can be varied by the person using a shower over the range of temperatures between ambient temperature and a temperature of between 95°F and 105°F.

22. (1) In every ship to which this Schedule applies a supply of drinking water shall be provided in the crew accommodation from tanks of an adequate capacity for the purpose having regard to the number of persons in the crew and the time likely to elapse between successive replenishments of the water, or by other equally efficient means.

Supply of drinking water.

(2) Where service tanks are fitted for that purpose they shall be directly connected with the ship's main drinking water storage tanks.

(3) In ships of 3,000 tons or over any pumping necessary for the supply of drinking water in crew accommodation shall be by mechanical power.

(4) Cold drinking water shall be laid on to taps in the galleys and pantries, and in the mess rooms provided for those members of the crew for whose use and service pantries are not provided.

(5) In every ship to which this Schedule applies, being a ship of 1,000 tons or over employed otherwise than as a Caribbean trade ship, means shall be provided whereby the crew shall obtain access to drinking water which has been cooled by passing through a cooling-tank or by other suitable means.

LAWS OF TRINIDAD AND TOBAGO

MINISTRY OF THE ATTORNEY GENERAL AND LEGAL AFFAIRS

www.legalaffairs.gov.tt

792

Chap. 50:10

Shipping

[Subsidiary]

Shipping (Crew Accommodation) Regulations

Laundry facilities, etc.

23. (1) In every ship to which this Schedule applies, being a ship of 500 tons or over, washing troughs or other suitable facilities shall be provided to enable the crew to wash their clothes, and shall be adequate in size and sufficient in number for that purpose.

(2) Such troughs shall be made of or coated with hygienic and durable material having a smooth and impervious surface not likely to crack, flake or become corroded.

(3) The troughs or other facilities shall be situated in a room appropriated for use only as a laundry.

(4) The troughs or other facilities may be situated in the crew's washing accommodation if the provision of a separate laundry is unreasonable or impracticable in the circumstances.

(5) The troughs or other facilities shall be provided with an adequate supply of hot and cold fresh water, and shall be so arranged as to discharge overboard or into an enclosed tank served by a mechanically operated suction pump.

(6) In every ship to which this Schedule applies rooms for drying the crew's clothes shall be provided and shall be separate from sleeping rooms, mess rooms, recreation rooms, offices, storerooms, galleys, pantries and hospitals and shall be fitted with racks or rods with sufficient space having regard to the number of persons in the crew and the duration of the voyages on which the ship is intended to be engaged.

(7) The heating of such rooms shall be capable of being controlled independently of the heating of any other space in the ship.

(8) The exhaust ventilation of such rooms shall be independent of the ventilation of all other spaces in the ship unless it is provided by a trunked mechanical ventilation system.

(9) In ships of under 500 tons drying cabinets or other suitable facilities may be substituted for a drying room.

(10) In every ship to which this Schedule applies adequately ventilated compartments or lockers shall be provided for hanging oilskins and working clothes used by the crew.

(11) Separate compartments or lockers shall be provided for officers and ratings.

(12) The compartments or lockers shall be situated outside the sleeping rooms the crew and in a position readily accessible therefrom.

Water closets.

24. (1) In every ship to which this Schedule applies, each of the following classes of persons shall be provided with water closets separate from those provided for the other classes:

(a) officers and apprentices;

UNOFFICIAL VERSION

UPDATED TO 31ST DECEMBER 2016

- (b) petty officers; and
- (c) ratings other than petty officers.

(2) One water closet shall be provided for every 8 persons in each of the classes as aforesaid and each of such classes shall be provided with at least one water closet.

(3) One additional water closet shall be provided for any of such classes in which the total number of persons exceeds by 4 or more a multiple of 8.

(4) In determining the number of water closets required by this subparagraph no account shall be taken of—

- (a) any private water closet; or
- (b) the persons for whose use a private water closet is appropriated.

(5) Where the number of persons in any class exceeds 100, the number of water closets provided for that class shall be the greater of the following:

- (a) 13; or
- (b) 10, together with 4 per cent of the number of persons in excess of 100, calculated to the next following whole number.

(6) For the purpose of this subparagraph a water closet shall be deemed to be private if it is appropriated for the sole use of not more than 4 persons.

(7) In addition to the water closets required by subparagraphs (2) and (3), there shall be provided such number of water closets, if any, as is required to increase the total number of water closets provided for the crew to the following:

- (a) in ships of 500 tons but under 800 tons ... .. 3
- (b) in ships of 800 tons but under 3,000 tons ... .. 4
- (c) in ships of 3,000 tons or over ... .. 6

(8) In determining the number of water closets required by this paragraph no account shall be taken of any water closet forming part of a permanent hospital.

(9) The water closets shall be situated close to the sleeping rooms of the persons for whom they are provided, and in particular a water closet shall be situated close to the sleeping rooms of any radio officers in the crew if such sleeping rooms are in a position remote from other sleeping rooms.

(10) Where the entrance to a water closet is from an open deck, the entrance shall, if practicable, be properly screened.

(11) Where the means of entry into water closets forming part of the crew accommodation is from a passageway leading to other parts of the crew accommodation, a lobby shall be provided at the entrance of the water closet, or, where a lobby is not practicable, a self-closing door.

(12) Any doors between a water closet and a passageway shall be close fitting and without apertures.

(13) Access to water closets shall not be obtained directly from a mess room or sleeping rooms.

(14) Access to a water closet may be obtained directly from not more than two sleeping rooms together accommodating not more than four persons.

(15) If the persons so accommodated are three or four in number, the water closet pedestal shall be so screened as to ensure privacy.

(16) Every water closet shall be completely enclosed by bulkheads and shall be provided with exhaust ventilation directly to the open air or to another water closet which is provided with ventilation directly to the open air.

(17) A water closet may be separated by a partition consisting of steel or other opaque and rigid material open at the top and bottom from—

- (a) another water closet;
- (b) a urinal; or
- (c) washing accommodation if the water closet is served by a trunked mechanical ventilation system which effectively removes odours therefrom.

(18) Every water closet shall be so constructed as to facilitate cleaning and not to harbour dirt or vermin.

(19) Subject to the provisions of subparagraph (20) every water closet shall be provided with the following:

- (a) a water closet pedestal of single type with—
  - (i) a pan of white vitreous china or other suitable material;
  - (ii) a seat of polished hardwood or other suitable material, with an opening of 4 inches at the front;
  - (iii) a trap with a metal inspection plate; and
  - (iv) an efficient ventilator connected to the outlet;
- (b) an adequate flush of water, which shall be always available and supplied through self-closing non-concussive supply valves with a portable seating in metal which is not likely to become corroded;
- (c) a soil pipe not less than 4 inches in diameter, so constructed as to facilitate cleaning and minimise the risk of obstruction which have a direct overboard outfall fitted with a storm-valve unless it is connected with a main sewerage outfall by an efficient and hygienic system;
- (d) a device for holding toilet paper; and
- (e) a handrail or grip.

(20) Every water closet provided for the exclusive use of special ratings shall be designed and equipped in a manner suited to the national habits and customs of those ratings and in particular shall be provided with—

- (a) a water closet pedestal of single type with a trapped pan of white vitreous china or other suitable material;
- (b) an arrangement which automatically flushes the pan at intervals not exceeding 5 minutes and provides a continuous trickle of water; and
- (c) a soil pipe such as is referred to in subparagraph 19(c) which shall be provided with a metal inspection plate and efficient ventilation.

(21) The provisions of this paragraph shall not apply to water closets forming part of a permanent hospital.

25. (1) Every ship to which this Schedule applies shall be provided with Galleys. a galley for the preparation of food for the crew unless the circumstances are such that no members of the crew are required to mess on board.

(2) The galley shall be situated as near as may be to the mess rooms provided for the crew and any necessary equipment shall be provided to enable food to be served hot in the mess rooms under all weather conditions.

(3) The galley shall be situated in a position which will prevent, as far as is practicable, the entry into the galley of coal dust from coal chutes or bunker hatchways.

(4) There shall be no direct opening between the galley and any sleeping room.

(5) Any galley situated on an open deck shall be provided with weather doors which are horizontally divided into halves so that the upper half can be opened independently of the lower half where such a division is necessary for the lighting, ventilation or privacy of the galley or for the service of food therefrom.

(6) Every galley shall, so far as is reasonable and practicable, be lighted by natural lighting from all the sides and from overhead.

(7) Every galley shall be provided with at least three fixed points for artificial lighting, one of which shall be situated close to a cooking range required by this paragraph.

(8) Where the galley is situated on an open deck openings shall be cut in the sides and ends of the galley for ventilation purposes and shall be fitted with dust-tight shutters made of steel or other suitable material and permanently attached to the structure of the galley.

(9) Every galley shall be provided with exhaust fans which will draw off fumes from the cooking appliances therein and discharge the fumes into the open air.

LAWS OF TRINIDAD AND TOBAGO

(10) The floor of the galley shall be provided with gutters and with scuppers which shall be led overboard or to an enclosed tank served by a mechanically operated suction pump.

(11) The position and number of the gutters and scuppers shall be such as will ensure the efficient drainage of the floor.

(12) The cooking appliances in the galley shall be arranged in a manner which will facilitate the cleaning of the galley.

(13) All cupboards and dressers in the galley shall be made of material which is impervious to dirt and moisture and can easily be kept clean. All metal parts of the cupboards and dressers shall be rustproof.

(14) The cupboards and dressers shall be so made as not to be likely to harbour dirt or vermin.

(15) The bottom of all cupboards and dressers in the galley shall either be flush with the deck or shall be so fitted as to enable the deck space beneath them to be readily accessible for cleaning.

(16) Every galley shall be provided with such equipment as will enable food in sufficient quantity to be properly and readily prepared for the persons whom the galley is intended to serve, and the cooking utensils to be hygienically cleansed.

(17) Without prejudice to the generality of the last preceding paragraph—

(a) every galley shall be provided with one or more cooking appliances with—

- (i) a total oven capacity, suitable for roasting and baking, of at least ¼ cubic foot; and
- (ii) an area of range top-plate or boiling table, amounting to at least ⅓ square foot for each person whom the galley is intended to serve;

(b) every galley shall be provided with at least the number of ovens specified in the following table:

<i>Number of persons whom the galley is intended to serve</i>	<i>Number of ovens</i>
---	----------------------------

not more than 20	... .. 1
more than 20, but not more than 60	... .. 2
more than 60	... .. 3

(c) the top-plate of every cooking range shall be at a height which will enable it to be conveniently used by a person of normal height standing on the floor of the galley, unless a separate boiling table is provided at such a height.

(18) Salt water taps shall not be fitted over a sink in any galley or other place in which food may be prepared for the crew.

(19) Hot and cold fresh water shall be laid on to a sink in the galley for washing-up purposes.

(20) A connection shall be provided on a water pipe within the galley and shall be suitable for the connection of a hose with which the floor may be scoured.

26. (1) In every ship to which this Schedule applies, not being a ship in which each member of the crew provides his own food, one or more storerooms shall be provided for the storage of dry provisions for the crew. Dry provision storerooms.

(2) Such rooms shall be fitted with sufficient shelves, cupboards and bins having regard to the maximum period likely to elapse between successive replenishments of stores and to maximum number of persons for whom food is to be served.

(3) Every dry provision storeroom shall be enclosed by bulkheads constructed of steel or other suitable material.

(4) Access to every dry provision storeroom shall be obtained from a passageway, galley, pantry or another storeroom, or from a position on an open deck which, in so far as is reasonable and practicable in the circumstances, shall be a protected position.

(5) Every dry provision storeroom shall be so situated, constructed and ventilated as to avoid deterioration of the stores through heat, draught, condensation or infestation by insects or vermin.

(6) Without prejudice to the generality of the foregoing paragraph no dry provision storeroom shall be situated over a boiler room or any other space in which heat is generated, or shall adjoin a galley or machinery casing.

(7) No part of a dry provision storeroom shall be used for the storage of bedding or textiles.

27. (1) In every ship to which this Schedule applies, being a ship regularly employed otherwise than as a Caribbean trade ship, refrigerating equipment and cold storerooms shall be provided and shall be, having regard to the period likely to elapse between successive replenishments of stores, adequate for the storage of perishable provisions for the crew. Cold store rooms and refrigerating equipment.

(2) Access to every cold storeroom shall be obtained from a passageway, galley or pantry or from another storeroom.

(3) Refrigerating machinery in which methyl chloride is intended to be used, whether or not intended to cool any space in the crew accommodation, shall not be situated in the crew accommodation except in a storeroom or in a space appropriated solely to that machinery.

LAWS OF TRINIDAD AND TOBAGO

MINISTRY OF THE ATTORNEY GENERAL AND LEGAL AFFAIRS

www.legalaffairs.gov.tt

798

Chap. 50:10

Shipping

[Subsidiary]

Shipping (Crew Accommodation) Regulations

(4) The storeroom or other space in which the machinery is situated shall be so constructed as to be gas-tight where it abuts upon other parts of the crew accommodation and shall be adequately ventilated by at least two ventilators to the open air one of which shall be fitted with an exhaust fan and shall have its inlet near the bottom of the room or space.

(5) The motor of the fan and the electrical connections thereto shall be enclosed in a spark-proof case.

(6) Access to such storeroom or space shall, wherever practicable, be by means of a hinged door from an open deck.

(7) Where the door cannot be arranged otherwise than to open on to a passageway or other space frequented by members of the crew, the door shall be spring-loaded, jointed and gastight.

(8) Every exposed pipe which may contain methyl chloride or other toxic or inflammable gas shall be adequately protected from damage.

Hospitals.

28. (1) Every ship to which this Schedule applies, being a ship, other than a whale catcher or a tug, which is intended to be at sea on any occasion for a continuous period of more than 3 days with a crew of 15 or more persons, shall be provided with a space appropriated for use as a permanent hospital for crew.

(2) The space so appropriated shall not at any time be used for any purpose other than for the treatment of sick persons.

(3) In every other ship to which this Schedule applies a room shall be appropriated for use, when necessary, as a temporary hospital.

(4) When such room is in use as a hospital it shall not be used for any purpose other than the treatment of sick persons.

(5) Every hospital, whether permanent or temporary, shall be situated in a position which will ensure the greatest possible quiet and comfort for the patients.

(6) The hospital shall be readily accessible, and, in the case of a ship not carrying a duly qualified medical practitioner or duly qualified nurse exclusively so employed as a member of the crew, shall be so situated as to be easily accessible from the sleeping accommodation of the Master of the ship or of a person appointed by the master to take charge of the patients.

(7) The hospital shall be so situated as to facilitate the proper treatment of patients in all weathers.

(8) The minimum width of the entrance to every permanent hospital shall be 30 inches or as near thereto as is practicable in the circumstances.

(9) The hospital shall be so arranged that a stretcher can easily be carried into the hospital and placed alongside at least one single-tier bed therein.

UNOFFICIAL VERSION

UPDATED TO 31ST DECEMBER 2016

(10) The floor-covering in every permanent hospital shall, as far as is practicable, be free from joins.

(11) Every permanent hospital shall include a hospital ward fitted on at least two sides with side scuttles at least 12 inches in diameter.

(12) The side scuttle shall be capable of being opened. Where it is not practicable to fit a side scuttle on two sides of the hospital ward, a skylight, capable of being opened and of as large a size as is practicable, may be substituted for a side scuttle on one side of the ward.

(13) All side scuttles in the hospital, and any skylight therein which is exposed to the direct rays of the sun, shall be provided with curtains, blinds or jalousies.

(14) In addition to any mechanical ventilation required by paragraph 9 of this Schedule, every permanent hospital shall be provided with adequate natural supply and exhaust ventilation to the open air by means of ventilators independent of the ventilators provided for any other space in the ship.

(15) Every hospital in every ship when regularly engaged, whether temporarily or permanently, on voyages to areas within the Persian Gulf shall be provided with a means of air-conditioning of sufficient capacity to maintain 84° Fahrenheit (dry bulb) with 50% relative humidity when the ambient conditions are 98° Fahrenheit (dry bulb) with 78% relative humidity.

(16) Every permanent hospital shall be provided with an electric fan, unless it is served by a trunked mechanical ventilation system.

(17) Any radiators in a permanent hospital shall be installed as far as is practicable from the heads of beds.

(18) In addition to the lighting required by paragraph 8 of this Schedule, every permanent hospital shall be provided with a portable electric lamp and with such accessories as are necessary for its use.

(19) In every ship which is required by this paragraph to be provided with a permanent hospital at least one bed shall be provided in a hospital ward for every 50, or fraction of 50, members of the crew.

(20) At least one single-tier bed shall be provided in a ward in every permanent hospital.

(21) The bed shall, if practicable, be so arranged as to be accessible from both sides and from the foot.

(22) Where any beds in the ward are arranged in double tiers, the upper tier shall be hinged or shall be removable.

(23) Subject to the foregoing provisions of this paragraph, the provisions of paragraph 14(2) to (10) of this Schedule shall apply to hospital beds as they apply to beds in a sleeping room.

LAWS OF TRINIDAD AND TOBAGO

MINISTRY OF THE ATTORNEY GENERAL AND LEGAL AFFAIRS

www.legalaffairs.gov.tt

800

Chap. 50:10

Shipping

[Subsidiary]

Shipping (Crew Accommodation) Regulations

(24) In every ward in a permanent hospital one of each of the following items of equipment shall be provided for each bed in the hospital ward and shall be within reach of that bed:

- (a) a locker approximately 1 foot square by 2 feet high, and fitted with a flat top and a shelf;
- (b) a water bottle; and
- (c) a tumbler.

(25) In every ward in a permanent hospital the following items of equipment shall be provided:

- (a) seats adequate in number, having regard to the number of beds in the ward;
- (b) a clothes locker additional to that required by subparagraph (24) and complying with the specifications set forth in paragraph 15(1)(a)(ii) of this Schedule;
- (c) a box cover which will conceal a bed-pan; and
- (d) electric bell-pushes so arranged as to be within reach of each bed and communicating with the sleeping room of a person in charge of the patients.

(26) A washbasin having a capacity of at least 1½ gallons shall be fitted in every permanent hospital.

(27) In ships of 5,000 tons or over a bath at least 4 feet 5 inches in internal length shall be fitted in washing accommodation forming part of the hospital and adjacent to the hospital ward.

(28) The washbasin and bath shall be made of or coated with hygienic and durable material having a smooth and impervious surface not likely to crack, flake or become corroded.

(29) They shall be fitted with an efficient and hygienic discharge system separate, if practicable, from any other discharge system in the ship and in particular the waste pipes shall be fitted in a manner which will facilitate cleaning.

(30) A scupper at least 2 inches in diameter shall be fitted in the lowest part of any room, other than a ward, which contains such washbasin or bath.

(31) A water closet pedestal shall be fitted as part of every permanent hospital.

(32) The water closet pedestal shall be fitted either in a water closet or in washing accommodation forming part of the hospital.

(33) Access to the water closet pedestal, or washing accommodation, as the case may be, shall be obtained directly from the hospital ward or from a lobby forming part of the hospital.

UNOFFICIAL VERSION

UPDATED TO 31ST DECEMBER 2016

(34) The room in which the water closet pedestal is installed shall be provided with a gastight self-closing door unless it is served by a mechanical system of exhaust ventilation, and shall be so constructed as to facilitate cleaning and not to harbour dirt or vermin.

(35) Such room shall be ventilated in the manner specified in paragraph 24(16) of this Schedule and shall comply with the requirements of paragraph 24(19) or (20), whichever shall be applicable in the circumstances.

29. (1) In every ship to which this Schedule applies a medical cabinet shall be provided in a position adjacent to the permanent hospital, if any, required by paragraph 28 of this Schedule or near to the sleeping room of the person in charge of sick persons on board. Medical cabinet.

(2) The medical cabinet shall be fitted in a position in which it will remain dry and which is remote from all sources of heat.

(3) The medical cabinet shall be of a size, design and construction suitable for storing the medicines, medical stores and book of instructions provided in the ship for the benefit of the seamen on board.

(4) The medical cabinet shall be provided with the following:

- (a) an outer door fitted with an efficient lock;
- (b) an inner cupboard fitted with a door and a lock which shall be incapable of being opened by the key to the lock referred to in subparagraph (a) which shall be used solely for the storage of poisonous drugs;
- (c) shelves so constructed as to facilitate the identification of medicines stored thereon;
- (d) a dispensing counter or dispensing table, in either case with a surface which can easily be kept clean;
- (e) at least two drawers suitable for the storage of medical stores and used solely for that purpose;
- (f) fittings which will enable hot water bottles to be carried in a hanging position;
- (g) a rack suitable for holding devices for measuring medicines; and
- (h) a book containing readily understandable instructions for the use of medicines and medical stores provided for the crew, unless the ship carries a duly qualified medical practitioner as a member of the crew.

(5) The medical cabinet shall be lighted by an electric light which shall be inside or immediately outside the cabinet, and which will enable all the contents of the cabinet to be clearly seen in the absence of light from any other source.

**LAWS OF TRINIDAD AND TOBAGO**

MINISTRY OF THE ATTORNEY GENERAL AND LEGAL AFFAIRS

www.legalaffairs.gov.tt

802

**Chap. 50:10**

*Shipping*

**[Subsidiary]**

*Shipping (Crew Accommodation) Regulations*

(6) The medical cabinet and the place in which it is fitted shall be so ventilated as to avoid deterioration of the contents of the cabinet.

Protection from mosquitoes.

30. (1) In every ship to which this Schedule applies, the crew accommodation, other than galleys, storerooms and recreation spaces on the open deck shall be provided with protection against the admission of mosquitoes.

(2) Such protection shall be provided by means of screens of rust-proof wire or other suitable material which shall be fitted to all side scuttles, natural ventilators, skylights, and doors leading to the open deck.

(3) Any door to which such screens are fitted, being a door at the entrance to a permanent or temporary hospital in a ship to which this Schedule applies, shall be of a self-closing type.

Maintenance and inspection of crew accommodation.

31. (1) The crew accommodation in every ship to which this Schedule applies shall be maintained in a clean and habitable condition, and all equipment and installations required by this Schedule shall be maintained in good working order.

(2) Every part of the crew accommodation, not being a storeroom, shall be kept free of stores and other property not belonging to or provided for the use of persons for whom that part of the accommodation is appropriated, and in particular no cargo shall be kept in any part of the crew accommodation.

(3) The master of the ship or an officer appointed by him for the purpose shall inspect every part of the crew accommodation at intervals not exceeding seven days, and shall be accompanied on the inspection by one or more members of the crew.

(4) The master of the ship shall cause to be entered in the ship's official log book a record of—

- (a) the time and date of the inspection;
- (b) the names and ranks of the persons making the inspection; and
- (c) particulars of any respects in which the crew accommodation or any part thereof was found by any of the persons making the inspection not to comply with this Schedule.

Accommodation shares with passengers.

32. (1) No accommodation provided in compliance with this Schedule shall be used, or appropriated for use, by passengers.

(2) No galley or storeroom provided in compliance with this Schedule shall be used, or appropriated for use, for the preparation of storage or food for passengers.

UNOFFICIAL VERSION

UPDATED TO 31ST DECEMBER 2016

APPENDIX 1

Paragraphs 4(2)  
and 5(4).

DECK SHEATHINGS

1. The material referred to in paragraphs 4(2) and 5(4) of this Schedule (in this Appendix referred to as “the material”) shall comply with the following requirements:

- (a) *Foothold*. The material, whether wet or dry, shall provide a good foothold.
- (b) *Thermal Insulation*—
  - (i) where the material covers a deck exposed to the weather, it shall provide thermal insulation not less than that provided by a wooden deck  $2\frac{1}{4}$  inches thick;
  - (ii) where the material covers any other deck, it shall provide a warm and comfortable surface.
- (c) *Fire Resistance*. The material shall be such as will not readily ignite in the position in which it is laid.
- (d) *Water Absorption*. The material shall be such that, after being immersed in water for a period of 48 hours, the moisture content of the material will not exceed 7 per cent of its dry weight.
- (e) *Adhesion*. The material shall be so laid as to adhere closely under all conditions of service to the surface on which it is laid.
- (f) *Non-corrosion*. The material shall not contain any substance which may cause corrosion of the deck on which it is laid, unless the deck is effectively protected from corrosion by a coating applied for that purpose.
- (g) *Danger to Persons*. The material shall be such as will not produce any injurious effect upon persons who may come in contact with it.
- (h) *Resistance to wear and weather*. The material shall be sufficiently hard and strong to withstand all conditions of service and shall be sufficiently flexible to prevent cracking under those conditions.

2. Where the material is laid in a permanent hospital, it shall be material not likely to be damaged by surgical spirit or other liquids which may be used in the hospital.

3. Where the material is laid on the crown of an oil fuel tank, the material shall be such that if it is immersed in fuel oil for a period of 24 hours at a temperature of 150° F the weight of the material will not increase by more than 1 per cent and the material will not be penetrated by the oil.

Paragraph 9(8).

## APPENDIX 2

## TRUNKED MECHANICAL VENTILATION SYSTEM

1. The trunked mechanical ventilation system referred to in paragraph 9(8) of this Schedule (in this Appendix referred to as “the system”) shall in relation to the spaces specified in the second column of Table I annexed hereto, be capable of the respective standards of performance specified in the third or fourth column of that Table, whichever standard shall be the higher in the circumstances.

2. Nothing in Table I shall be taken to relate to a space specified in the second column of Table II annexed hereto.

3. The system shall, in relation to the spaces specified in the second column of Table II, be capable of the respective standards of performance specified in the third and fourth columns of that Table.

4. Where any storeroom is served by a fan which provides warmed air for any other space, the storeroom shall be provided with ventilation trunking separate from that serving such other space.

5. The clear area of the exhaust openings provided in conjunction with the system shall be sufficient to ensure that the velocity of air at each exhaust opening does not exceed 1,000 feet per minute when the system is in operation.

6. The speed of every supply fan forming part of the system shall be capable of being varied where direct current motors are used.

7. The system shall be quiet in operation.

8. All trunking forming part of the system shall be provided with non-return flaps where such flaps are necessary for the exclusion of effluvia and the preservation of the health of the crew.

9. Where the system is designed to circulate heated air as the sole means of heating the crew accommodation, the system shall be subdivided into sections which can be separately controlled to the extent necessary to enable a comfortable temperature to be maintained in all parts of the crew accommodation.

10. TABLE I

1	2	3	4
Category	Space	Fresh air changes per hour	Volume of fresh air, in cubic feet per minute, for each person likely to use the room at any one time
A	Rooms (other than rooms in category C) in deck houses above the upper or shelter deck— (1) outside rooms other than rooms adjoining machinery casing ... .. (2) inside rooms and rooms adjoining machinery casing ... ..	10  15	10  50
B	Rooms (other than rooms in category C) in side-to-side superstructures above the upper or shelter deck— (1) outside rooms (other than rooms adjoining machinery casing) ... .. (2) inside rooms and rooms adjoining machinery casing ...	12  15	50  50
C	Mess rooms, smoking rooms and recreation rooms, in each case above the upper or shelter deck— (1) not adjoining machinery casing ... .. (2) adjoining machinery casing ... ..	15  18	25(a)  25(a)
D	Passageways adjoining machinery casing ... ..	4	—

**LAWS OF TRINIDAD AND TOBAGO**

MINISTRY OF THE ATTORNEY GENERAL AND LEGAL AFFAIRS

www.legalaffairs.gov.tt

806

**Chap. 50:10**

*Shipping*

**[Subsidiary]**

*Shipping (Crew Accommodation) Regulations*

10. TABLE I—*Continued*

1	2	3	4
Category	Space	Fresh air changes per hour	Volume of fresh air, in cubic feet per minute, for each person likely to use the room at any one time
E	Rooms in between decks, including shelter between decks, of ships propelled by internal combustion machinery—		
	(1) Rooms clear of machinery casing ... ..	12	50
	(2) Rooms abreast of but not adjoining machinery casing ...	12	50
	(3) Rooms adjoining machinery casing, other than mess rooms, smoking rooms and recreation rooms ... ..	15	60
	(4) Mess rooms, smoking rooms and recreation rooms (in each case adjoining machinery casing) ... ..	18	25
F	Rooms in between decks, including shelter between decks, of steamships—		
	(1) Rooms clear of machinery casing ... ..	12	50
	(2) Rooms abreast of, but not adjoining machinery casing ...	15	60
	(3) Rooms immediately above machinery casing or abreast of an adjoining machinery casing, other than mess rooms, smoking rooms and recreation rooms ...	18	60
	(4) Mess rooms, smoking rooms and recreation rooms in each case adjoining machinery casing ... ..	20	30(b)

UNOFFICIAL VERSION

UPDATED TO 31ST DECEMBER 2016

- (a) Whatever the number of persons likely to use the room at any one time, the total volume of fresh air per minute shall not be required to be such as would result in more than 20 fresh air changes per hour.
- (b) Whatever the number of persons likely to use the room at any one time, the total volume of fresh air per minute shall not be required to be such as would result in more than 25 fresh air changes per hour.

11. TABLE II

1 Category	2	3 Fresh air changes per hour		4
		Supply	Exhaust	
G	Galleys	20(c)		—
H	Sanitary accommodation, drying rooms and pantries	10		—
I	Wards in permanent hospitals	12 or such greater number as would result in the supply of not less than 50 cubic feet of fresh air per minute for each bed in the room		—
J	Dry provisions storerooms	Not less than 10(d) and not more than 20		—

- (c) 15, if at least two sides of the galley are exposed to the weather.
- (d) Subject to the provisions of paragraph 26(5).

**LAWS OF TRINIDAD AND TOBAGO**

MINISTRY OF THE ATTORNEY GENERAL AND LEGAL AFFAIRS

www.legalaffairs.gov.tt

808

**Chap. 50:10**

*Shipping*

[Subsidiary]

*Shipping (Crew Accommodation) Regulations*

Paragraph 12.

**APPENDIX 3**

**MARKING**

**PART I**

Markings for sleeping rooms—

Certified for (\*) seamen

Certified for A (1) seamen

Certified for (\*) seamen or A (1) seamen

**PART II**

Markings for spaces other than sleeping rooms—

Certified for Chief Officer (!)

Certified for Officers

Certified for Petty Officers

Certified for Apprentices

Certified for Crew

(\*) There shall be here inserted the maximum number of seamen who may be accommodated in the room in accordance with this Schedule when it is not appropriated for use solely by special ratings.

(1) There shall here be inserted the maximum number of seamen who may be accommodated in the room in accordance with this Schedule when it is appropriated for use solely by special ratings.

(!) In the case of a room intended for the sole use of any other Officer the rank of that Officer shall here be substituted.

---

UNOFFICIAL VERSION

UPDATED TO 31ST DECEMBER 2016

**SHIPPING (TRAINING, CERTIFICATION, SAFE  
MANNING, HOURS OF WORK AND WATCHKEEPING)  
REGULATIONS**

ARRANGEMENT OF REGULATIONS

**REGULATION**

1. Citation.

**PART I**

**PRELIMINARY**

2. Interpretation.
3. Application.
- 3A. Seafarer's certification.
- 3B. Seafarer's certificate.
- 3C. Period of validity.
- 3D. Issue, form, validity, record and surrender of certificates.
- 3E. Expiration of certificates.
- 3F. Revalidation.

**PART II**

**APPROPRIATE CERTIFICATES**

4. Masters and officers to hold appropriate certificates.
5. Qualification of masters, chief mates and officers in charge of a navigational watch.
6. Qualification as chief engineer officers, second engineer officers and officers in charge of an engineering watch.
7. Recognition of appropriate certificates.
- 7A. Appropriate certificates.

**PART III**

**CERTIFICATE AND TRAINING**

8. Familiarisation and basic safety training.
9. Qualification as rating forming part of a navigational watch.
10. Qualification as rating forming part of an engine room watch.
11. Radio-communication and radio personnel on GMDSS ships.
12. Training and qualification of seafarers on tankers.

**LAWS OF TRINIDAD AND TOBAGO**

MINISTRY OF THE ATTORNEY GENERAL AND LEGAL AFFAIRS

www.legalaffairs.gov.tt

810

**Chap. 50:10**

*Shipping*

[Subsidiary]

*Shipping (Training, Certification, Safe Manning, Hours of Work and Watchkeeping) Regulations*

ARRANGEMENT OF REGULATIONS—*Continued*

**REGULATION**

13. Training and qualification of seafarers on ro-ro passenger ships.
14. Training and qualification of seafarers on passenger ships other than ro-ro passenger ships.
- 14A. Training and qualification of masters and seafarers on high-speed craft.
15. Training and qualification of seafarers on survival craft and rescue boats.
- 15A. Hovercraft.
16. Service at sea to be approved.
17. Requirements for training in advanced fire-fighting.
18. Requirements relating to medical first aid and medical care.
19. Documentary evidence of training to be provided.
20. Recognition of documentary evidence, certificates other than appropriate certificates and training.
- 20A. Endorsement.
21. Restrictions on recognition.
22. *(Repealed by LN 9/2012).*
23. Refusal of certificates or endorsements and reviews.
24. Loss or deprivation of certificates, endorsements or dispensation.
- 24A. Certificates for Near Coastal Voyages.

**PART IV**

**QUALITY STANDARDS**

25. Training, assessment and maintenance of quality standards.

**PART V**

**SAFE MANNING AND HOURS OF WORK**

26. Responsibilities of companies, masters and other seafarers regarding familiarisation, training and certification.
27. Ships to be safely manned.
28. Responsibilities of companies and masters regarding safe manning.

UNOFFICIAL VERSION

UPDATED TO 31ST DECEMBER 2016

**REGULATION**

29. Safe manning document.
30. Determination of safe manning levels.
31. Company to inform of changes.
32. Circumstances of exceptional necessity.
33. Dispensations.
34. Application of certain regulations.
35. General duty of companies, employers and masters regarding hours of work.
36. Duties of seafarers.
37. Schedule of duties and need to maintain records.
38. Exceptions for emergencies.
39. Failure to comply with provisions relating to hours of work and rest.
40. Duty to keep copy of Regulations.

**PART VI**

**WATCHKEEPING**

41. Watchkeeping arrangements.
42. Watchkeeping arrangements in port.
43. Watchkeeping arrangements in port for ships carrying hazardous cargo.

**PART VII**

**MISCELLANEOUS**

44. Prohibition on the employment of young persons.
45. Common language.
46. Inspection of ships.
47. Power to detain.
48. Parity of treatment of STCW ships and non-STCW ships.
49. Penalties.
50. Exemptions.
51. Fees.

**LAWS OF TRINIDAD AND TOBAGO**

MINISTRY OF THE ATTORNEY GENERAL AND LEGAL AFFAIRS

www.legalaffairs.gov.tt

812

**Chap. 50:10**

*Shipping*

---

[Subsidiary]

*Shipping (Training, Certification, Safe Manning, Hours of Work  
and Watchkeeping) Regulations*

ARRANGEMENT OF REGULATIONS—*Continued*

REGULATION

52. *(LN No. 248 of 2001 is revoked).*

53. *(LN No. 254 of 2001 is revoked).*

**FIRST SCHEDULE.**

**SECOND SCHEDULE.**

**THIRD SCHEDULE.**

**FOURTH SCHEDULE.**

**FIFTH SCHEDULE.**

**SIXTH SCHEDULE.**

**SEVENTH SCHEDULE.**

**EIGHTH SCHEDULE.**

---

UNOFFICIAL VERSION

UPDATED TO 31ST DECEMBER 2016

**SHIPPING (TRAINING, CERTIFICATION,  
SAFE MANNING, HOURS OF WORK AND  
WATCHKEEPING) REGULATIONS**

81/2002.  
[9/2012].

*made under sections 87, 111 and 406*

1. These Regulations may be cited as the Shipping (Training, Certification, Safe Manning, Hours of Work and Watchkeeping) Regulations. Citation.

**PART I**

**PRELIMINARY**

2. In these Regulations—

Interpretation.  
[9/2012].

“Act” means the Shipping Act;

“appropriate certificate” means a certificate issued and endorsed by an STCW country, in accordance with the provisions of the STCW Convention, entitling the holder of the certificate to serve in the capacity and perform the functions involved, at the level of responsibility specified therein, on a ship of the type, tonnage or power and means of propulsion concerned, while engaged on the particular voyage concerned;

“approved” means approved by the Minister in accordance with the STCW Convention;

“authorised person” means a person authorised by the Minister for the purposes of these Regulations;

“Caribbean Trading Area” has the meaning assigned to it in the First Schedule;

First Schedule.

“certificate” means a valid document, by whatever name it may be known, issued or recognised by Trinidad and Tobago or an STCW country, authorising the holder thereof to serve as stated in the document or as authorised by Trinidad and Tobago or the STCW country;

“chemical tanker” means a ship constructed or adapted and used for the carriage, in bulk, of any liquid product listed in the Table in Chapter 17 of the IBC Code;

LAWS OF TRINIDAD AND TOBAGO

MINISTRY OF THE ATTORNEY GENERAL AND LEGAL AFFAIRS

www.legalaffairs.gov.tt

814

Chap. 50:10

Shipping

[Subsidiary]

*Shipping (Training, Certification, Safe Manning, Hours of Work  
and Watchkeeping) Regulations*

“company” means the owner of a ship or any other organisation or person who has assumed the responsibility for the operation of the ship from the owner and who, on assuming such responsibility, has agreed to take over all the duties and responsibilities imposed on a company by these Regulations;

“constructed” means that the keel of a ship is laid or at a similar stage of construction and “similar stage of construction” means a stage at which—

(a) construction, identifiable with a specific ship, has commenced; and

(b) assembly of the ship has commenced, comprising at least fifty tonnes or one per cent of the estimated mass of all structural material, whichever is less;

“Director” means the Director of Maritime Services;

Sub. Leg.

“GT” means gross tonnage as determined in accordance with regulation 6 of the Shipping (Tonnage) Regulations;

“HSC Code” means the International Code on Safety for High Speed Craft adopted by the Maritime Safety Committee of the International Maritime Organisation by resolution MSC. 36(63), as amended by the International Maritime Organisation;

“high speed craft” has the meaning assigned to it in the HSC Code;

“IBC Code” means the International Code for the Construction and Equipment of Ships Carrying Dangerous Chemicals in Bulk;

“IGC Code” means the International Code for the Construction and Equipment of Ships Carrying Liquefied Gases in Bulk;

“IMO” means the International Maritime Organisation;

“liquefied gas tanker” means a ship constructed or adapted and used for the carriage, in bulk, of any liquefied gas or other product listed in the Table in Chapter 19 of the IGC Code;

UNOFFICIAL VERSION

UPDATED TO 31ST DECEMBER 2016

“management level” means the level of responsibility associated with—

- (a) serving as master, chief mate, chief engineer officer or second engineer officer on board a ship; and
- (b) ensuring that all functions within the designated area of responsibility are properly performed;

“master” includes a seafarer having command or charge of a ship, other than a pilot;

“Minister” means the Minister to whom the responsibility for shipping is assigned;

“month” means a period of thirty days;

“near coastal voyage” means a voyage within the Caribbean Trading Area during which a ship is at no time more than one hundred and fifty miles from a safe port of refuge;

“officer” means a seafarer, other than a master, engaged on board a ship in the capacity of officer under the terms of the safe manning document issued in respect of the ship;

“oil” means petroleum in any form including crude oil, fuel oil, sludge, oil refuse and refined products other than oil-like substances which are subject to Annex II of the International Convention for the Prevention of Pollution from Ships, 1973/78;

“oil tanker” means a ship constructed or adapted primarily to carry oil in bulk in its cargo spaces and includes a combination carrier when it is carrying a cargo or part cargo of oil in bulk;

“operational level” means the level of responsibility associated with—

- (a) serving as officer in charge of a navigational watch or an engineering watch or as designated duty engineer for periodically unmanned machinery spaces or as radio operator on board a ship; and

LAWS OF TRINIDAD AND TOBAGO

MINISTRY OF THE ATTORNEY GENERAL AND LEGAL AFFAIRS

www.legalaffairs.gov.tt

816

Chap. 50:10

Shipping

[Subsidiary]

*Shipping (Training, Certification, Safe Manning, Hours of Work and Watchkeeping) Regulations*

(b) maintaining direct control over the performance of all functions within the designated area of responsibility in accordance with proper procedures and under the direction of a seafarer serving at management level within the area of responsibility;

“passenger ship” means a ship which is constructed or is habitually or on any particular occasion used, for carrying more than twelve passengers;

“pleasure craft” has the meaning assigned to it in the Shipping Act;

“propulsion power” means the total maximum continuous rated output power, in kilowatts, of a ship’s main propulsion machinery, as stated on the ship’s certificate of registry or other official document;

“Radio Regulations” means the Radio Regulations annexed to, or regarded as being annexed to, the International Telecommunication Convention to which Trinidad and Tobago is a party;

“rating” means a member of the ship’s crew other than the master or an officer;

“ro-ro passenger ship” means a passenger ship with ro-ro cargo spaces or special category spaces as defined in the SOLAS Convention;

“Sea area A1”, “Sea area A2”, “Sea area A3” and “Sea area A4”, respectively, have the meanings assigned to them in Regulation 2, Chapter IV of the SOLAS Convention;

“seafarer” includes a master, an officer and a rating;

“seagoing” means going to sea beyond the limits of the internal waters of Trinidad and Tobago as defined in the Archipelagic Waters and Exclusive Economic Zone Act;

“Secretary-General” means the Secretary-General of the IMO;

“SOLAS Convention” means the International Convention for the Safety of Life at Sea, 1974 and its Protocol of 1978, as amended;

Ch. 51:06.

UNOFFICIAL VERSION

UPDATED TO 31ST DECEMBER 2016

“STCW Code” means the Seafarers’ Training, Certification and Watchkeeping Code adopted by the 1995 Conference of Parties to the International Convention on the Standards of Training, Certification and Watchkeeping for Seafarers, 1978;

“STCW Convention” means the International Convention on Standards of Training, Certification and Watchkeeping for Seafarers, 1978, as amended;

“STCW country” means a country, other than Trinidad and Tobago, which is a party to the STCW Convention;

“STCW ship” means a ship entitled to fly the flag of an STCW country;

“tanker” means—

- (a) a chemical tanker;
- (b) a liquefied gas tanker; and
- (c) an oil tanker; and

“unlimited trading area” means any area in which voyages which are not near coastal voyages are not taken.

**3.** (1) Subject to subregulation (2), these Regulations Application. apply to—

- (a) a seagoing Trinidad and Tobago; and
- (b) a foreign ship when in Trinidad and Tobago waters,

and a seafarer serving thereon.

(2) These Regulations do not apply to a seafarer serving on board a—

- (a) warship, naval auxiliary or a ship owned or operated by a State and engaged only on governmental, non-commercial service;
- (b) fishing vessel;
- (c) pleasure craft; or
- (d) wooden ship of primitive build.

LAWS OF TRINIDAD AND TOBAGO

MINISTRY OF THE ATTORNEY GENERAL AND LEGAL AFFAIRS

www.legalaffairs.gov.tt

818

Chap. 50:10

Shipping

[Subsidiary]

*Shipping (Training, Certification, Safe Manning, Hours of Work and Watchkeeping) Regulations*

Seafarer's  
certification.  
[9/2012].

**3A.** (1) No person shall perform the duties of a seafarer on a Trinidad and Tobago ship unless he holds a certificate to so perform issued by the Director.

(2) A person who wishes to perform the duties of a seafarer on a Trinidad and Tobago ship shall apply in the prescribed form to the Director to so perform.

(3) An application under subregulation (2) shall be accompanied by—

(a) the prescribed fee; and

(b) the appropriate certificate of qualification referred to in regulation 7A.

Seafarer's  
certificate.  
[9/2012].

**3B.** The Director, where he is satisfied that the applicant meets the prescribed requirements, may issue a Seafarer's Certificate in the prescribed form.

Period of  
validity.  
[9/2012].

**3C.** A certificate issued under regulation 3A shall be valid for a period of five years and may be revalidated.

Issue, form,  
validity, record  
and surrender  
of certificates.  
[9/2012].

**3D.** (1) A holder of a certificate shall keep his certificate in its original form on board the ship on which he is serving.

(2) A record of certification, endorsements and dispensations issued under these Regulations and of any alteration of or any other matters affecting the certificates, endorsements and dispensations shall be kept in such manner as the Director may require and include the information specified in Part A of the Second Schedule and any other information which may be specified by the IMO from time to time.

Second  
Schedule.

(3) Where a seafarer is convicted of an offence under section 93 of the Act or where a certificate or an endorsement is issued and the conditions for its issue specified in these Regulations or by the Director, have not been complied with, the holder of the certificate or endorsement shall, at the direction of the Director, deliver it for cancellation to the Director or to such person as the Director may direct.

UNOFFICIAL VERSION

UPDATED TO 31ST DECEMBER 2016

(4) The Director shall make available, information on the status of such certificates, endorsements and dispensations as are referred to in subregulation (1), to STCW countries and companies which request verification of the authenticity and validity of certificates produced to them by seafarers seeking recognition of their certificates or for employment on board a ship.

(5) The Director may request from STCW countries, information on certificates, endorsements and dispensations issued by them, where such certificates, endorsements and dispensations are produced to the Director by seafarers seeking recognition of their certificates or seeking employment on board a Trinidad and Tobago ship or by seafarers serving on board a foreign ship operating in Trinidad and Tobago waters.

(6) Where the holder of a certificate is issued with an appropriate certificate at a higher level he shall surrender the first-mentioned certificate for cancellation to the Director, or to such person as the Director directs.

**3E.** Where the period of validity of a certificate expires, the holder of such expired certificate may apply to the Director in the prescribed form for the certificate to be revalidated.

Expiration of  
certificates.  
[9/2012].

**3F.** An applicant for revalidation meets seagoing service where he meets continued professional competence as follows:

Revalidation.  
[9/2012].

- (a) approved seagoing service performing functions appropriate to the certificate held for a period of at least one year in total during the preceding five years;
- (b) having performed functions considered to be equivalent to the seagoing service required under paragraph (a); or
- (c) one of the following:
  - (i) passing an approved test;
  - (ii) successfully completing an approved course or courses; or

**LAWS OF TRINIDAD AND TOBAGO**

MINISTRY OF THE ATTORNEY GENERAL AND LEGAL AFFAIRS

www.legalaffairs.gov.tt

820

**Chap. 50:10**

*Shipping*

[Subsidiary]

*Shipping (Training, Certification, Safe Manning, Hours of Work and Watchkeeping) Regulations*

- (iii) having completed approved seagoing service, performing functions appropriate to the certificate held for a period of not less than three months in a supernumerary capacity, or in a lower officer rank than that for which the certificate held is valid immediately prior to taking up the rank for which it is valid; and

(d) on payment of the prescribed fee,

revalidate the certificate of the applicant for a further period of five years.

**PART II**

**APPROPRIATE CERTIFICATES**

Masters and officers to hold appropriate certificates. [9/2012].

**4. (1)** A person shall be qualified as a master or an officer where he holds an appropriate certificate from an institution for Maritime Training recognised by the Maritime Services Division in one of the following capacities:

- (a) master;
- (b) chief mate;
- (c) officer in charge of a navigational watch;
- (d) chief engineer officer;
- (e) second engineer officer;
- (f) officer in charge of an engineering watch; or
- (g) radio operator.

(2) A master or an officer shall hold an appropriate certificate for the capacity in which he serves as follows:

- (a) master or chief mate on a ship of 3000 GT or more;
- (b) master or chief mate on a ship of between 500 and 3000 GT;
- (c) master on a ship of less than 500 GT, engaged on near-coastal voyages;

UNOFFICIAL VERSION

UPDATED TO 31ST DECEMBER 2016

- (d) officer in charge of a navigational watch on a ship of less than 500 GT, engaged on near-coastal voyages;
  - (e) officer in charge of a navigational watch on a ship of 500 GT or more;
  - (f) officer in charge of an engineering watch in a manned engine room or designated duty engineer officer in a periodically unmanned engine room, on a ship powered by main propulsion machinery of 750 kilowatts propulsion power or more;
  - (g) chief engineer officer or second engineer officer on a ship powered by main propulsion machinery of 3000 kilowatts propulsion power or more; and
  - (h) chief engineer officer or second engineer officer on a ship powered by main propulsion machinery of between 750 and 3000 kilowatts propulsion power.
- (3) In respect of service on a ship of less than 500 GT, not engaged on near-coastal voyages—
- (a) an officer in charge of a navigational watch shall hold an appropriate certificate for the capacity of officer in charge of a navigational watch on a ship of 500 GT or more; and
  - (b) a master shall hold an appropriate certificate for the capacity of master on a ship of between 500 and 3000 GT.
- (4) Notwithstanding subregulations (2) and (3), a master or an officer, who holds an appropriate certificate for a higher capacity may serve in any lower capacity.
- (5) Notwithstanding subregulation (2), an engineer officer who—
- (a) is qualified to serve as second engineer officer on a ship powered by main propulsion machinery of 3000 kilowatts propulsion power or more; and

LAWS OF TRINIDAD AND TOBAGO

MINISTRY OF THE ATTORNEY GENERAL AND LEGAL AFFAIRS

www.legalaffairs.gov.tt

822

Chap. 50:10

Shipping

[Subsidiary]

*Shipping (Training, Certification, Safe Manning, Hours of Work and Watchkeeping) Regulations*

- (b) has served as engineer officer in a position of responsibility for a period of approved seagoing service of not less than twelve months,

may serve in the capacity of chief engineer officer on a ship powered by main propulsion machinery of less than 3000 kilowatts propulsion power, provided that his appropriate certificate is endorsed with a statement that he has served as engineer officer in a position of responsibility for a period of approved seagoing service of not less than twelve months.

Qualification of masters, chief mates and officers in charge of a navigational watch.

5. (1) An officer in charge of a navigational watch on a ship of 500 GT or more shall have—

- (a) attained eighteen years of age;
- (b) approved seagoing service of not less than—
  - (i) one year as part of an approved training programme which—
    - (A) includes on-board training which meets the requirements of section A-II/1 of the STCW Code; and
    - (B) is documented in an approved training record book; or
  - (ii) three years;
- (c) performed, during the approved seagoing service, bridge watchkeeping duties under the supervision of the master or a qualified officer for a period of not less than six months;
- (d) met any applicable requirements of regulation 11 for performing designated radio duties; and
- (e) completed approved education and training referred to and met the standard of competence specified in section A-II/1 of the STCW Code.

(2) A master or chief mate on a ship of 3000 GT or more shall have—

- (a) met the requirements for certification as officer in charge of a navigational watch on a ship of

UNOFFICIAL VERSION

UPDATED TO 31ST DECEMBER 2016

500 GT or more and had approved seagoing service as follows:

- (i) for certification as chief mate, not less than twelve months as officer in charge of a navigational watch on a ship of 500 GT or more; or
  - (ii) for certification as master, not less than—
    - (A) thirty-six months as officer in charge of a navigational watch on a ship of 500 GT or more; or
    - (B) twenty-four months as officer in charge of a navigational watch on a ship of 500 GT or more and twelve months as chief mate; and
  - (b) completed approved education and training referred to and met the standard of competence specified in section A-II/2 of the STCW Code, for a master or chief mate on a ship of 3000 GT or more, as the case may be.
- (3) A master or chief mate on a ship of between 500 and 3000 GT shall have—
- (a) met the requirements for certification as officer in charge of a navigational watch on a ship of 500 GT or more;
  - (b) completed approved education and training referred to and met the standard of competence specified in section A-II/2 of the STCW Code, for a master or chief mate on ship of between 500 and 3000 GT, as the case may be; and
  - (c) for certification as master, approved seagoing service of not less than—
    - (i) thirty-six months as officer in charge of a navigational watch on a ship of 500 GT or more; or
    - (ii) twenty-four months as officer in charge of a navigational watch on a ship of 500 GT or more and twelve months as chief mate.

LAWS OF TRINIDAD AND TOBAGO

MINISTRY OF THE ATTORNEY GENERAL AND LEGAL AFFAIRS

www.legalaffairs.gov.tt

824

Chap. 50:10

Shipping

[Subsidiary]

*Shipping (Training, Certification, Safe Manning, Hours of Work and Watchkeeping) Regulations*

(4) An officer in charge of a navigational watch on a ship of less than 500 GT engaged on near-coastal voyages shall have—

- (a) attained eighteen years of age;
- (b) completed—
  - (i) special training, including an adequate period of approved seagoing service; or
  - (ii) approved seagoing service of not less than three years in the deck department;
- (c) met any applicable requirements of regulation 11 for performing designated radio duties; and
- (d) completed approved education and training referred to and met the standard of competence specified in section A-II/3 of the STCW Code for an officer in charge of a navigational watch on a ship of less than 500 GT engaged on near-coastal voyages.

(5) A master on a ship of less than 500 GT engaged on near-coastal voyages shall have—

- (a) attained twenty years of age;
- (b) approved seagoing service of not less than twelve months as officer in charge of a navigational watch; and
- (c) completed approved education and training referred to and met the standard of competence specified in section A-II/3 of the STCW Code for a master on a ship of less than 500 GT engaged on near-coastal voyages.

Qualification as chief engineer officers, second engineer officers and officers in charge of an engineering watch.

6. (1) An officer in charge of an engineering watch in a manned engine room or a designated duty engineer officer in a periodically unmanned engine room on a ship powered by main propulsion machinery of 750 kilowatts propulsion power or more shall have—

- (a) attained eighteen years of age;

UNOFFICIAL VERSION

UPDATED TO 31ST DECEMBER 2016

- (b) completed approved seagoing service of not less than six months in the engine department in accordance with section A-III/1 of the STCW Code; and
  - (c) completed a period of approved education and training of not less than thirty months including on-board training documented in an approved training record book and met the standard of competence specified in section A-III/1 of the STCW Code.
- (2) A chief engineer officer or second engineer officer on a ship powered by main propulsion machinery of 3000 kilowatts propulsion power or more shall have—
- (a) met the requirements for certification as officer in charge of an engineering watch;
  - (b) for certification as second engineer officer, approved seagoing service of not less than twelve months as assistant engineer officer or engineer officer;
  - (c) for certification as chief engineer officer, approved seagoing service of not less than thirty-six months of which not less than twelve months shall have been served as engineer officer in a position of responsibility while qualified to serve as second engineer officer; and
  - (d) completed approved education and training referred to and met the standard of competence specified in section A-III/2 of the STCW Code.
- (3) A chief engineer officer or second engineer officer on a ship powered by main propulsion machinery of between 750 and 3000 kilowatts propulsion power shall have—
- (a) met the requirements for certification as officer in charge of an engineering watch;
  - (b) for certification as second engineer officer, approved seagoing service of not less than

LAWS OF TRINIDAD AND TOBAGO

MINISTRY OF THE ATTORNEY GENERAL AND LEGAL AFFAIRS

www.legalaffairs.gov.tt

826

Chap. 50:10

Shipping

[Subsidiary]

*Shipping (Training, Certification, Safe Manning, Hours of Work and Watchkeeping) Regulations*

twelve months as assistant engineer officer or engineer officer;

- (c) for certification as chief engineer officer, approved seagoing service of not less than twenty-four months of which not less than twelve months shall have been served while qualified as second engineer officer; and
- (d) completed approved education and training referred to and met the standard of competence specified in section A-III/3 of the STCW Code.

Recognition of appropriate certificates. [9/2012].

7. (1) The Director may, for service on board a Trinidad and Tobago ship, recognise an appropriate certificate where he is satisfied that—

- (a) the requirements of the STCW Convention have been complied with, in respect of standards of competence, the issue and endorsement of certificates and record-keeping; and
- (b) prompt notification will be given to him by the issuing STCW country, of any significant change in the arrangements for training and certification.

(2) For the purpose of satisfying himself under subregulation (1), the Director—

- (a) with respect to the issuing STCW country, shall take into account any list of the IMO, of STCW countries which, according to the IMO, have given full and complete effect to the STCW Convention; and
- (b) with respect to verification of the authenticity and validity of an appropriate certificate presented for recognition, may—
  - (i) require from the issuing STCW country, copies of its maritime legislation and details of its facilities and procedures

UNOFFICIAL VERSION

UPDATED TO 31ST DECEMBER 2016

concerning the training and certification  
of seafarers; and

(ii) where he deems it necessary, inspect the  
facilities and procedures.

(3) An appropriate certificate to be recognised shall—

(a) be in its original form; and

(b) where it is in a language other than English, be  
accompanied by an official translation in the  
English language.

(4) Where the Director recognises an appropriate  
certificate, he shall issue an endorsement attesting to the  
recognition of the appropriate certificate.

(5) An endorsement issued under subregulation (4) shall—

(a) be on the form set out in Part B of the Second  
Schedule; Part B.  
Second  
Schedule.

(b) be assigned the same number as that of the  
appropriate certificate concerned, where that  
number is unique;

(c) state the capacity in which the holder of the  
appropriate certificate is authorised to serve; and

(d) expire as soon as the appropriate certificate  
endorsed, expires or is withdrawn, suspended or  
cancelled by the issuing STCW country and, in  
any case, not more than five years after the date  
of issue.

(6) A seafarer who presents for recognition, an appropriate  
certificate as certification at management level or operational level,  
shall satisfy the Director that he has proficiency in the English  
language relevant to the functions which he is permitted to perform  
and in the case of certification at management level, knowledge of  
the maritime legislation of Trinidad and Tobago, in accordance with  
the requirements specified in the Third Schedule.

Third Schedule.

LAWS OF TRINIDAD AND TOBAGO

MINISTRY OF THE ATTORNEY GENERAL AND LEGAL AFFAIRS

www.legalaffairs.gov.tt

828

Chap. 50:10

Shipping

[Subsidiary]

*Shipping (Training, Certification, Safe Manning, Hours of Work  
and Watchkeeping) Regulations*

(7) The Director may, where the circumstances require, authorise a seafarer to serve in a capacity other than radio operator, except as provided in the Radio Regulations, for a period not exceeding three months, on board a Trinidad and Tobago ship, where the seafarer holds an appropriate certificate which has not yet been endorsed to attest to its recognition, where he is satisfied that the seafarer has applied for an endorsement.

(8) A seafarer authorised under subregulation (7) shall keep readily available on board the ship, documentary proof that he has applied for the endorsement.

(9) Notwithstanding regulation 4 and subregulation (5)(c), the Director may issue to a suitably qualified seafarer who holds an appropriate certificate, an endorsement attesting to the recognition of the appropriate certificate and authorising the seafarer to serve on a ship engaged on near-coastal voyages, in a capacity or at a level, other than that stated in the appropriate certificate, subject to such restrictions or conditions that the Director may consider necessary, having regard to the safety of all seafarers and ships which may be operating in the same waters.

(10) Subregulation (9) shall not apply to service on a tanker or passenger ship.

(11) The Director may revoke or cancel, at any time, an endorsement issued under subregulation (4), where he has reasonable grounds for believing that the holder of the appropriate certificate in respect of which the endorsement was issued has—

- (a) violated any provision of the Act or Regulations made thereunder;
- (b) committed an offence under the laws of Trinidad and Tobago;
- (c) demonstrated a lack of sobriety, good character or conduct; or
- (d) failed to maintain the required standard of medical fitness.

UNOFFICIAL VERSION

UPDATED TO 31ST DECEMBER 2016

**7A.** (1) The Director may issue to a master or an officer who is qualified under this regulation, a certificate in the form set out in the Fourth Schedule.

Appropriate certificates. Fourth Schedule. [9/2012].

(2) A person shall only be entitled to be issued with such an appropriate certificate under these Regulations where he complies with the criteria in sections A—II/I to A—VI/IV-5 of the Code annexed to the STCW Convention and any other requirements specified by the Director under these Regulations.

### PART III

#### CERTIFICATION AND TRAINING

**8.** A seafarer shall have completed familiarisation and basic safety training and instruction in accordance with section A-VI/1 of the STCW Code and met the appropriate standard of competence specified therein.

Familiarisation and basic safety training.

**9.** (1) A rating forming part of a navigational watch on a ship of 500 GT or more, other than a rating under training and a rating whose duties while on watch are of an unskilled nature, shall have—

Qualification as rating forming part of a navigational watch. [9/2012].

(a) attained sixteen years of age;

(b) completed—

(i) approved seagoing service including not less than six months training and experience; or

(ii) special training, either before going to sea for the first time or on board ship, including approved seagoing service of not less than two months,

associated with navigational watchkeeping functions and involving the performance of duties carried out under the direct supervision of the master, the officer in charge of the navigational watch or a qualified rating; and

LAWS OF TRINIDAD AND TOBAGO

MINISTRY OF THE ATTORNEY GENERAL AND LEGAL AFFAIRS

www.legalaffairs.gov.tt

830

Chap. 50:10

Shipping

[Subsidiary]

Shipping (Training, Certification, Safe Manning, Hours of Work and Watchkeeping) Regulations

(c) met the standard of competence specified in section A-II/4 of the STCW Code.

(2) *(Deleted by LN 9/2012).*

Qualification as rating forming part of an engine room watch. [9/2012].

**10.** (1) A rating forming part of an engine room watch or designated to perform duties in a periodically unmanned engine room, on a ship powered by main propulsion machinery of 750 kilowatts propulsion power or more, other than a rating under training and a rating whose duties are of an unskilled nature, shall have—

(a) attained sixteen years of age;

(b) completed—

(i) approved seagoing service including not less than six months training and experience; or

(ii) special training, either before going to sea for the first time or on board ship, including approved seagoing service of not less than two months,

associated with engine room watchkeeping functions and involving the performance of duties carried out under the direct supervision of a qualified engineer officer or a qualified rating; and

(c) met the standard of competence specified in section A-III/4 of the STCW Code.

(2) *(Deleted by LN 9/2012).*

Radio-communication and radio personnel on GMDSS ships.

**11.** (1) The crew of a ship shall include a seafarer who—

(a) is qualified for the distress and safety radio communication purposes specified in subregulation (3); and

(b) holds a certificate specified in the Radio Regulations as appropriate.

(2) The master shall designate one seafarer qualified in accordance with subregulation (1) to have primary responsibility for radio communications during incidents of distress.

UNOFFICIAL VERSION

UPDATED TO 31ST DECEMBER 2016

(3) A seafarer qualified in accordance with subregulation (1), serving on board a ship operating in Sea area A1, shall hold at least a Global Maritime Distress and Safety System (GMDSS) restricted operator's certificate issued in accordance with the Radio Regulations.

(4) A seafarer qualified in accordance with subregulation (1), serving on board a ship operating in Sea areas A1/A2, A1/A2/A3 and A1/A2/A3/A4 shall hold a Global Maritime Distress and Safety System (GMDSS) general operator's certificate issued in accordance with the Radio Regulations.

(5) A candidate for certification under this regulation, for service on board a ship which is required by the SOLAS Convention to have a radio installation shall have—

- (a) attained eighteen years of age; and
- (b) completed approved education and training referred to and met the standard of competence specified in section A-IV/2 of the STCW Code.

**12.** (1) An officer or a rating assigned specific duties and responsibilities related to cargo or cargo equipment on a tanker shall have—

Training and qualification of seafarers on tankers. [9/2012].

- (a) satisfied the requirements of regulation 8;
- (b) completed an approved shore-based advanced fire-fighting course specified in section A-VI/3 of the STCW Code and met the required standard of competence; and
- (c) completed—
  - (i) approved seagoing service of not less than three months on a tanker in order to acquire adequate knowledge of safe operational practices; or
  - (ii) an approved tanker familiarisation course which covers the syllabus given for the course in section A-V/1 of the STCW Code.

LAWS OF TRINIDAD AND TOBAGO

MINISTRY OF THE ATTORNEY GENERAL AND LEGAL AFFAIRS

www.legalaffairs.gov.tt

832

Chap. 50:10

Shipping

[Subsidiary]

*Shipping (Training, Certification, Safe Manning, Hours of Work  
and Watchkeeping) Regulations*

(2) Notwithstanding subregulation (1)(c)(i), a period of supervised seagoing service which is not less than one month may be approved where—

- (a) the tanker on which the service is performed is of less than 3000 GT;
- (b) the duration of any voyage of the tanker does not exceed seventy-two hours; and
- (c) the operational characteristics of the tanker and the number of voyages and loading and discharging operations completed during the period, allow the same level of knowledge and experience to be acquired as would have been acquired in service performed in accordance with subregulation (1)(c)(i), on a tanker of a size and performing voyages, not falling within paragraphs (a) and (b) of this subregulation.

(3) A master chief mate, chief engineer officer, second engineer officer or any seafarer assigned immediate responsibility for loading, discharging and care in transit or handling of cargo on a tanker shall, in addition to meeting the requirements of subregulation (1)(c)(i) or (ii), have—

- (a) experience appropriate to his duties on the type of tanker on which he serves; and
- (b) completed an approved specialised training programme which covers the subjects specified in section A-V/1 of the STCW Code that are appropriate to his duties on the type of tanker on which he serves.

(4) An appropriate endorsement shall be issued on certificates of competence to officers and ratings who are qualified in accordance with subregulation (1) or (3) as appropriate, and every rating who is so qualified shall be certified.

(5) *(Deleted by LN 9/2012).*

UNOFFICIAL VERSION

UPDATED TO 31ST DECEMBER 2016

**13.** (1) Prior to being assigned shipboard duties on board a ro-ro passenger ship, a seafarer shall have completed the training required by subregulations (3) to (7) in accordance with his capacity, duties and responsibilities.

Training and qualification of seafarers on ro-ro passenger ships. [9/2012].

(2) A seafarer who is required to be trained in accordance with subregulations (3), (6) and (7), shall at intervals not exceeding five years—

- (a) undertake approved refresher training; or
- (b) provide evidence of having achieved the required standard of competence within the previous five years.

(3) A master, an officer or a seafarer designated on a muster list to assist passengers in emergency situations on board a ro-ro passenger ship shall have completed approved crowd management training referred to in section A-V/2, paragraph 1 of the STCW Code.

(4) A master, an officer or a seafarer assigned specific duties and responsibilities on board a ro-ro passenger ship shall have completed approved familiarisation training referred to in section A-V/2, paragraph 2 of the STCW Code.

(5) A seafarer who provides direct service to passengers in passenger spaces on board a ro-ro passenger ship shall have completed approved safety training referred to in section A-V/2, paragraph 3 of the STCW Code.

(6) A master, chief mate, chief engineer officer, second engineer officer or any seafarer assigned immediate responsibility for embarking and disembarking passengers, loading, discharging or securing cargo or closing hull openings on board a ro-ro passenger ship shall have completed approved training in passenger safety, cargo safety and hull integrity referred to in section A-V/2, paragraph 4 of the STCW Code.

(7) A master, chief mate, chief engineer officer, second engineer officer or any seafarer assigned responsibility for the

safety of passengers in emergency situations on board a ro-ro passenger ship shall have—

- (a) completed approved crisis management and human behaviour training referred to in section A-V/2, paragraph 5 of the STCW Code; and
- (b) met the required standard of competence.

(8) Any documentary evidence issued by an STCW country to a seafarer who is trained and qualified in accordance with these Regulations may be recognised in accordance with regulation 7, for service as referred to in these Regulations on board ro-ro passenger ships.

Training and qualification of seafarers on passenger ships other than ro-ro passenger ships. [9/2012].

**14.** (1) This regulation applies to a seafarer serving on board a passenger ship, other than a ro-ro passenger ship.

(2) Prior to being assigned shipboard duties on board a passenger ship, a seafarer shall have completed the training required by subregulations (4) to (8) in accordance with his capacity, duties and responsibilities.

(3) A seafarer who is required to be trained in accordance with subregulations (4), (7) and (8) shall, at intervals not exceeding five years—

- (a) undertake appropriate refresher training; or
- (b) provide evidence of having achieved the required standard of competence within the previous five years.

(4) A seafarer designated on a muster list to assist passengers in emergency situations on board a passenger ship shall have completed approved crowd management training specified in section A-V/3, paragraph 1 of the STCW Code.

(5) A master, an officer or a seafarer assigned specific duties and responsibilities on board a passenger ship shall have completed approved familiarisation training specified in section A-V/3, paragraph 2 of the STCW Code.

(6) A seafarer who provides direct service to passengers in passenger spaces on board a passenger ship, shall have completed approved safety training referred to in section A-V/3, paragraph 3 of the STCW Code.

(7) A master, chief mate or a seafarer assigned immediate responsibility for embarking and disembarking passengers shall have completed approved passenger safety training referred to in section A-V/3, paragraph 4, of the STCW Code.

(8) A master, chief mate, chief engineer officer, second engineer officer and any seafarer assigned responsibility for the safety of passengers in emergency situations on board a passenger ship, shall have completed approved crisis management and human behaviour training referred to in section A-V/3, paragraph 5 of the STCW Code.

(9) Any documentary evidence issued by a STCW country to a seafarer who is trained and qualified in accordance with these Regulations may be recognised in accordance with regulation 7, for service on board passenger ships other than ro-ro ships.

**14A.** (1) This regulation applies to masters, officers and seafarers serving on board high-speed craft constructed on or after 1st January 1996.

Training and qualification of masters and seafarers on high-speed craft. [9/2012].

(2) Prior to being assigned shipboard duties on board a high-speed craft, masters and seafarers shall have completed the training specified in the Fourth Schedule A.

Fourth Schedule A.

(3) A person providing the training referred to in this regulation shall issue documentary evidence to every person successfully completing such training.

(4) In the case of a master or a seafarer having an operational role on a high-speed craft, the documentary evidence under subregulation (3) shall be a certificate in the form specified in the Fifth Schedule and shall be endorsed in a manner specified in that Schedule.

Fifth Schedule.

LAWS OF TRINIDAD AND TOBAGO

MINISTRY OF THE ATTORNEY GENERAL AND LEGAL AFFAIRS

www.legalaffairs.gov.tt

836

Chap. 50:10

Shipping

[Subsidiary]

*Shipping (Training, Certification, Safe Manning, Hours of Work and Watchkeeping) Regulations*

(5) Documentary evidence issued by an STCW country to a seafarer who is trained and qualified in accordance with this regulation may be recognised in accordance with regulation 6, for service on a high-speed craft.

Training and qualification of seafarers on survival craft and rescue boats. [9/2012].

**15. (1)** A seafarer designated to launch or take charge of a survival craft or a rescue boat other than a fast rescue boat, shall have—

- (a) attained eighteen years of age;
- (b) met the standard of competence specified in section A-VI/2, paragraphs 1 to 4 of the STCW Code; and
- (c) approved seagoing service of not less than—
  - (i) twelve months; or
  - (ii) six months in addition to approved training.

Fifth Schedule.

(2) The Director may issue to a person who satisfies the requirements of subregulation (1), a Certificate of Proficiency on the form set out in the \*Fifth Schedule.

(3) An examination for a Certificate of Proficiency in survival craft and rescue boats other than fast rescue boats shall be conducted by an examiner appointed for the purpose by the Director.

(4) In this regulation “fast rescue boat” means a rescue boat which is—

- (a) not less than six metres in length and not more than eight point five metres in length; and
- (b) capable of manoeuvring, for at least four hours, at a speed of at least twenty knots, in calm water, with a suitably qualified crew of three persons, and at least eight knots, with a full complement of persons and equipment.

\*The Fifth Schedule which contained the forms for a Certificate of Proficiency has been repealed and replaced with a new Fifth Schedule.

**15A.** (1) This regulation applies to every seagoing hovercraft registered in Trinidad and Tobago which was constructed on or after 1st January 1996. Hovercraft. [9/2012].

(2) It shall be the duty of every owner of a hovercraft to which this regulation applies to ensure that masters, seafarers and other personnel on a hovercraft, wing in ground craft and air cushioned vessels have completed the appropriate training.

(3) It shall be the duty of any person providing the training referred to in this regulation to issue documentary evidence to every person successfully completing such training.

(4) In the case of masters and officers, having an operational role on high-speed craft, the documentary evidence shall be a certificate in a form specified and endorsed in a manner prescribed by the Director.

(5) Regulations 18, 19 and 20 apply to certificates issued under regulation 25(4)(a) as they apply to other certificates or endorsements issued under these Regulations.

(6) The Director may exempt the owner of any hovercraft, wing in ground craft and air cushioned vessels from any of the requirements of this regulation, subject to such conditions as he may specify, and may alter or cancel any exemption so granted.

(7) Where the Director exempts anyone under subregulation (6), he may at any time alter or cancel such exemption.

**16.** (1) The Director may approve seagoing service on a ship actively engaged in commercial trading, except service on a— Service at sea to be approved. [9/2012].

(a) fishing vessel;

(b) ship or barge not fitted with approved survival craft; or

(c) ship of less than twenty-four metres in length,

for the purpose of certification of a seafarer.

LAWS OF TRINIDAD AND TOBAGO

MINISTRY OF THE ATTORNEY GENERAL AND LEGAL AFFAIRS

www.legalaffairs.gov.tt

838

Chap. 50:10

Shipping

[Subsidiary]

*Shipping (Training, Certification, Safe Manning, Hours of Work and Watchkeeping) Regulations*

(2) Notwithstanding any provision to the contrary in these Regulations, the Director may approve fifty per cent of a seafarer's service at sea on a ship trading primarily in the Gulf of Paria, for the purpose of certification of the seafarer.

(3) In calculating the length of the periods of actual service, a discharge book or a certificate of discharge shall be conclusive evidence of the period of time a seafarer has served at sea.

(4) Service at sea to be approved shall be performed within the period of five years preceding the date upon which certification is sought, subject to the discretion of the Director.

Requirements for training in advanced fire-fighting.

**17.** (1) A seafarer designated to control fire-fighting operations shall have completed advanced training in techniques for fighting fire with particular emphasis on organisation, tactics and command, referred to in section A-VI/3 of the STCW Code and shall have met the required standard of competence.

(2) Where training in advanced fire-fighting is not included in the qualifications for the issue of a certificate held by a seafarer designated to control fire-fighting operations, the seafarer shall be in possession of a special certificate or documentary evidence, indicating that he has attended a course of training in advanced fire-fighting referred to in subregulation (1).

Requirements relating to medical first aid and medical care. [9/2012].

**18.** (1) A seafarer designated to provide medical first aid on board a ship shall have met the standard of competence in medical first aid referred to in section A-VI/4, paragraphs 1 to 3 of the STCW Code.

(2) A seafarer designated to take charge of medical care on board a ship shall have met the standard of competence in medical care referred to in section A-VI/4, paragraphs 4 to 6 of the STCW Code.

(3) Where training in medical first aid or medical care is not included in the qualifications for the issue of a certificate held

UNOFFICIAL VERSION

UPDATED TO 31ST DECEMBER 2016

by a seafarer, the seafarer shall be in possession of a special certificate or documentary evidence, indicating that he has attended a course of training in medical first aid or in medical care, as the case may be.

(4) Where the level of knowledge detailed in column 2 of Table A—VI/4–2 of the STCW Code shall be sufficient to enable the designated seafarer to take immediate effective action in the case of accidents or illness likely to occur on board a ship.

**19.** An authorised person who provides training referred to in these Regulations shall give documentary evidence to a person who completes the training and meets the required standard of competence.

Documentary evidence of training to be provided.

**20.** (1) The Minister may recognise documentary evidence or a certificate, issued to a seafarer by an STCW country, other than an appropriate certificate where—

Recognition of documentary evidence, certificates other than appropriate certificates and training.

- (a) the seafarer has completed courses of training as referred to in regulations 8 to 18; and
- (b) he is satisfied that the documentary evidence or certificate has been issued in accordance with the STCW Convention.

(2) The Minister may, for the purpose of certification under these Regulations, approve seagoing service performed on an STCW ship and education and training provided by a training institution of an STCW country.

**20A.** (1) The Director may recognise a certificate issued to a seafarer by an STCW country and issue an endorsement in respect of same.

Endorsement. [9/2012].

(2) An endorsement under subregulation (1) may be issued as a separate document and shall—

- (a) be assigned a unique number, except that endorsements attesting the issue of a certificate

LAWS OF TRINIDAD AND TOBAGO

MINISTRY OF THE ATTORNEY GENERAL AND LEGAL AFFAIRS

www.legalaffairs.gov.tt

840

Chap. 50:10

Shipping

[Subsidiary]

*Shipping (Training, Certification, Safe Manning, Hours of Work and Watchkeeping) Regulations*

may be assigned the same number as the certificate concerned, provided that the number is unique; and

- (b) expire as soon as the certificate endorsed expires or is withdrawn, suspended or cancelled by the party which issued it, in any case, not more than five years after the date of issue.

Restrictions on recognition.

**21.** (1) The Minister shall not recognise documentary evidence or certificate issued by a country, that is not an STCW country.

(2) An endorsement issued by an STCW country attesting to the recognition of an appropriate certificate or any document issued by an STCW country in recognition of documentary evidence or a certificate other than an appropriate certificate shall not be used as the basis for recognition by the Minister.

(3) Notwithstanding subregulation (1), the Minister may, for the purpose of certification under these Regulations, approve seagoing service, education and training acquired by a seafarer under the authority of a country that is not an STCW country.

**22. (Repealed by LN 9/2012.)**

Refusal of certificates or endorsements and reviews. [9/2012].

**23.** (1) Notwithstanding that an applicant for a certificate or an endorsement has complied with the standards or fulfilled the conditions under these Regulations, the Director shall not issue or revalidate a certificate or an endorsement unless he is satisfied, having regard to all the relevant circumstances, that the applicant is a fit person to be the holder of the certificate or endorsement and to act in the capacity to which it relates.

(2) Where the Director intends to refuse the issue or revalidation of a certificate or an endorsement for any reason, he shall give notice in writing to the applicant, who shall have the right, before a date specified in the notice, to require the application to be reviewed by a board of inquiry.

UNOFFICIAL VERSION

UPDATED TO 31ST DECEMBER 2016

(3) Where the applicant has required his case to be reviewed by a board of inquiry, the Director shall cause an inquiry to be held in accordance with section 90 of the Act.

**24.** Where a seafarer has lost or is deprived of his certificate, endorsement or dispensation, the Director—

- (a) where he is satisfied that the seafarer has lost or been deprived of the certificate, endorsement or dispensation without fault on his part, shall; or
- (b) where he is not so satisfied, may,

Loss or deprivation of certificates, endorsements or dispensation. [9/2012].

upon receipt of any fee payable, cause to be issued to the seafarer a certified copy of the certificate, endorsement or dispensation to which the seafarer appears to be entitled.

**24A.** (1) The Director, in defining Near Coastal Voyages for the purposes of recognising certificates of compliance shall recognise the following:

Certificates for Near Coastal Voyages. [9/2012].

- (a) the Unlimited Trading Area; and
- (b) the Caribbean Trading Area for ships engaged in Near Coastal Trade.

(2) Where the Director is satisfied that an applicant is qualified for a near coastal voyage he shall issue a certificate of compliance to the applicant.

(3) The Director may also issue endorsements to suitably qualified seafarers who hold certificates of competence, allowing them to serve, subject to certain restrictions, in stated capacities or levels on near coastal voyages.

(4) The Director, if he is of the view that a ship's size and the conditions of its voyage are such as to render the application of the full requirements of this regulation as well as section A-II/3 of the STCW Code unreasonable or impracticable, may to that extent exempt the master and the officer in charge of a navigational watch on such a ship or class of ships from some of the requirements, bearing in mind the safety of all ships which may be operating in the same waters.

(5) The Director may issue a certificate restricted to service on ships engaged exclusively on near-coastal voyages and, for the issue of such a certificate, may exclude such subjects as are not applicable to the waters or ships concerned, bearing in mind the effect on the safety of all ships which may be operating in the same waters.

## PART IV

## QUALITY STANDARDS

Training,  
assessment and  
maintenance of  
quality  
standards.  
[9/2012].  
Eighth  
Schedule.

**25.** (1) The training and assessment of a seafarer shall be administered, supervised and monitored in accordance with the provisions of section A-I/6 of the STCW Code.

(2) The provisions of the Eighth Schedule shall apply in respect of the assessment of seafarers ashore for certification under regulation 4.

(3) Under the direction of the Director and in accordance with section A-I/8 of the STCW Code, a quality standards system shall be established, through which all activities relating to training, assessment of competence, certification, endorsement and revalidation shall be continuously monitored to ensure the achievement of defined objectives including those concerning the qualifications and experience of an instructor or assessor.

(4) The performance standards and other provisions set forth in section A-I/12 and such other requirements as are prescribed in Part A of the STCW Code for any certificate concerned shall be complied with in respect of—

- (a) all mandatory simulator-based training;
- (b) any assessment of competence required by Part A of the STCW Code which is carried out by means of a simulator; and
- (c) any demonstration, by means of a simulator of continued proficiency required by Part A of the STCW Code.

(5) Simulators installed or brought into use prior to 1st February 2002 shall be exempt from full compliance with the performance standards referred to in subregulation (4).

(6) Education and training provided by maritime training institutions of an STCW country other than Trinidad and Tobago may be recognised by the Director for the purpose of examination and certification under these Regulations.

(7) No STCW training for the purpose of certification shall be conducted by any person, institution or organisation without the expressed approval or consent of the Director.

#### PART V

#### SAFE MANNING AND HOURS OF WORK

**26.** (1) A company shall ensure that—

- (a) a seafarer on its ship has had training and holds a certificate in respect of a function he is required to perform on the ship, in accordance with these Regulations or the STCW Convention, as the case may be; and
- (b) documentation and data relevant to a seafarer on its ship are maintained and readily available for inspection and include, without being limited to, documentation and data on his experience, training, medical fitness and competence in respect of assigned duties.

Responsibilities of companies, masters and other seafarers regarding familiarisation, training and certification.

(2) Nothing in subregulation (1) shall prohibit the allocation of tasks for training under supervision or in circumstances of *force majeure*.

(3) A company shall provide written instructions to the master of its ship, setting out the policies and procedures to be followed to ensure that a seafarer who is newly employed on board the ship is given a reasonable opportunity to become familiar with the shipboard equipment, operating procedures and other arrangements needed for the proper performance of his duties, before being assigned to those duties.

LAWS OF TRINIDAD AND TOBAGO

MINISTRY OF THE ATTORNEY GENERAL AND LEGAL AFFAIRS

www.legalaffairs.gov.tt

844

Chap. 50:10

Shipping

[Subsidiary]

*Shipping (Training, Certification, Safe Manning, Hours of Work and Watchkeeping) Regulations*

(4) The policies and procedures referred to in subregulation (3) shall include—

(a) allocation of a reasonable period of time for a newly employed seafarer to have an opportunity to become familiarised with—

(i) the specific equipment the seafarer will be using or operating; and

(ii) ship-specific watchkeeping, safety, environmental protection and emergency procedures and arrangements the seafarer is required to know to properly perform his assigned duties; and

(b) designation of a knowledgeable crew member who shall be responsible for ensuring that an opportunity is provided to a newly employed seafarer to receive essential information in a language the seafarer understands.

(5) A master and any member of a crew designated with an obligation under this Regulation, shall perform that obligation.

Ships to be safely manned.

**27.** A ship shall be sufficiently and efficiently manned for its safe operation, having regard to the nature of its work and location.

Responsibilities of companies and masters regarding safe manning.

**28.** (1) A company shall ensure that its ship is manned with personnel of appropriate grades who have been trained and certificated, in accordance with these Regulations or the STCW Convention, as the case may be.

(2) The company shall ensure that, in relation to a ship of 500 GT or more—

(a) a safe manning document is in force in respect of the ship and the manning of the ship;

(b) the safe manning document is kept on board the ship at all times; and

UNOFFICIAL VERSION

UPDATED TO 31ST DECEMBER 2016

(c) the manning of the ship is maintained at all times at least at the levels specified in the safe manning document.

(3) The master of a ship shall ensure that the ship does not proceed to sea unless there is on board, a safe manning document issued in respect of the ship and that the manning of the ship complies with the document.

**29.** (1) An application for a safe manning document in respect of a Trinidad and Tobago ship shall be made to the Director by a company or a person authorised to act on its behalf.

Safe manning document.  
[9/2012].

(2) A fee shall be paid with respect to the application.

(3) A company which applies for a safe manning document shall submit to the Director, proposals as to the numbers and grade of seafarer it considers should be carried and hours of work so that the ship would be safely manned if it proceeded to sea on any intended voyage and in preparing such proposals, the company shall take into account the guidelines contained in the Sixth Schedule and any additional guidance issued by the Director.

Sixth Schedule.

(4) An application under subregulation (1) shall include a clear and concise explanation of how the proposed manning level and the hours of work have been determined, to enable the Minister to make an assessment of the application.

(5) A company may consult with seafarers or their representatives and the Director on its proposed manning levels and hours of work when new ships are at the design stage and prior to registering existing ships in Trinidad and Tobago.

(6) Where there is a disagreement between the company and seafarers or their representatives, regarding proposed manning levels and hours of work, the Director—

(a) shall consider any views put forward and may require a revision of the manning levels and hours of work, where he deems it necessary; and

LAWS OF TRINIDAD AND TOBAGO

MINISTRY OF THE ATTORNEY GENERAL AND LEGAL AFFAIRS

www.legalaffairs.gov.tt

846

Chap. 50:10

Shipping

[Subsidiary]

*Shipping (Training, Certification, Safe Manning, Hours of Work and Watchkeeping) Regulations*

(b) may arrange for some form of practical demonstration of the ability of the crew to carry out the essential tasks in the context of the principles of safe manning.

(7) Where the Director is satisfied that an application under subregulation (1) meets the requirements of this Part regarding the manning of a ship, a safe manning document shall be issued for the ship subject to such amendments and conditions as the Director sees fit.

(8) A company shall apply for the issue of a new safe manning document where there is a change in the equipment, construction or use of its ship, which may affect its safe manning levels.

(9) A safe manning document shall be in the form required as set out in paragraph 1.4 of the Sixth Schedule.

Determination of safe manning levels. [9/2012].

**30.** The Director shall consider a ship to be safely manned where in accordance with IMO Resolution A.(890) 21, the crew includes a sufficient number of officers and ratings, with appropriate skills and experience to—

- (a) maintain a safe bridge watch at sea in accordance with Regulation VIII/2 of STCW Convention, which includes general surveillance of the vessel;
- (b) moor and unmoor a vessel effectively and safely;
- (c) operate and maintain effectively, all watertight, closing arrangements including mounting an effective damage control party;
- (d) operate and where practicable, maintain efficiently, all fire equipment and life-saving appliances provided, including mustering and disembarking passengers and non-essential personnel;
- (e) manage the safety functions of a vessel at sea, where not underway;

UNOFFICIAL VERSION

UPDATED TO 31ST DECEMBER 2016

- (f) maintain a safe engineering watch at sea in accordance with Regulation VIII/2 of the STCW Convention, and a general surveillance of spaces containing main propulsion and auxiliary machinery;
- (g) operate and maintain in a safe condition, the main propulsion and auxiliary machinery to enable the ship to overcome the foreseeable perils of a voyage;
- (h) maintain the safety arrangements and the cleanliness of machinery spaces to minimise the risk of fire;
- (i) provide for medical care on board the ship;
- (j) maintain a safe radio watch in accordance with the SOLAS Convention and the International Telecommunications Union regulations, as amended;
- (k) maintain the precautions and safeguards necessary to protect the marine environment in accordance with the International Convention for the Prevention of Pollution from Ships, 1973/78; and
- (l) maintain safety in all operations of a ship while in port.

**31.** A company which has obtained a safe manning document, shall inform the Director as soon as any circumstance which is pertinent to the safe manning document changes, for the purpose of enabling the Director to review the document's continuing validity or approve new proposals from the company.

Company to inform of changes. [9/2012].

**32.** The Director may, in circumstances of exceptional necessity and where in his opinion no danger to persons, property or the environment shall be caused, permit a ship which is not manned in full compliance with the safe manning document, to proceed to sea for a specified period.

Circumstances of exceptional necessity. [9/2012].

LAWS OF TRINIDAD AND TOBAGO

MINISTRY OF THE ATTORNEY GENERAL AND LEGAL AFFAIRS

www.legalaffairs.gov.tt

848

Chap. 50:10

Shipping

[Subsidiary]

Shipping (Training, Certification, Safe Manning, Hours of Work  
and Watchkeeping) Regulations

Dispensations.  
[9/2012].

Seventh  
Schedule.

**33.** (1) Subject to subregulation (2), the Director may, in circumstances of exceptional necessity and where in his opinion no danger to persons, property or the environment shall be caused, issue a dispensation on the form set out in the Seventh Schedule, permitting a specified seafarer to serve on a specified ship for a specified period not exceeding six months, in a capacity other than radio operator, except as provided by the Radio Regulations, for which the seafarer does not hold the appropriate certificate, provided the seafarer to whom the dispensation is issued is adequately qualified to fill the vacant post in a safe manner, in accordance with the applicable safe manning requirements.

(2) A dispensation shall not be granted to a seafarer to act as master or chief engineer officer, except in circumstances of *force majeure* and in such circumstances shall be granted to an officer at management level and for the shortest duration possible.

(3) In granting a dispensation the Director shall specify the particular voyage or part of a voyage, for which the dispensation is valid.

(4) A dispensation shall be granted to a seafarer properly certificated to fill the post immediately below and where certification for the post is not required under these Regulations, a dispensation may be issued to a seafarer whose qualifications and experience are, in the opinion of the Director, of a clear equivalence to the requirements for the post to be filled, except where the seafarer does not hold an appropriate certificate, he shall be required to pass an examination acceptable to the Director as demonstrating that a dispensation may safely be issued.

(5) Where a dispensation is granted the Director shall ensure that the post in respect of which the dispensation was issued is filled by the holder of an appropriate certificate as soon as possible.

(6) The Director shall, as soon as practicable after the first day of January each year, submit to the Secretary-General, a report indicating the total number of dispensations granted for each capacity for which an appropriate certificate is required in

UNOFFICIAL VERSION

UPDATED TO 31ST DECEMBER 2016

respect of all seagoing Trinidad and Tobago ships and the numbers of those ships above and below 3000 GT.

**34.** Regulations 35 to 40 apply to a Trinidad and Tobago ship. Application of certain regulations.

**35.** (1) Subject to regulation 38, a company and an employer shall, in respect of a ship, ensure so far as is reasonably practicable, that a seafarer does not work more hours than is safe in relation to the safety of the ship and the seafarer's performance of his duties. General duty of companies, employers and masters regarding hours of work.

(2) Subject to regulation 38, a master of a ship shall ensure, so far as is reasonably practicable, that a seafarer does not work more hours than is safe in relation to the safety of the ship and the seafarer's performance of his duties.

**36.** A seafarer shall ensure, so far as is reasonably practicable, that he is properly rested when commencing duty on board a ship and obtains adequate rest during periods when he is off duty. Duties of seafarers.

**37.** (1) A company shall produce a schedule of duties. Schedule of duties and need to maintain records.

(2) Where a company is not the employer of the seafarers on its ship, it shall consult the employer of the seafarers before production of the schedule. [9/2012].

(3) The company may arrange with the employer to produce a schedule of duties in accordance with these Regulations and in such a case, the employer shall also be subject to the duties of the company under this regulation.

(4) Before producing a schedule, the company shall seek the views of the master and the master shall seek, and convey to the company, the views of—

- (a) the ship's safety committee; or
- (b) the seafarers or their representatives.

(5) Subject to subregulation (6), a schedule shall—

- (a) set out hours of work for—
  - (i) a master and a seafarer whose work includes regular watchkeeping duties or ship handling; and

LAWS OF TRINIDAD AND TOBAGO

MINISTRY OF THE ATTORNEY GENERAL AND LEGAL AFFAIRS

www.legalaffairs.gov.tt

850

Chap. 50:10

Shipping

[Subsidiary]

*Shipping (Training, Certification, Safe Manning, Hours of Work and Watchkeeping) Regulations*

- (ii) a chief mate, chief engineer officer and second engineer officer,

so that they are not required to work more hours than are safe in relation to the safety of the ship and the performance of their duties;

- (b) specify the maximum period of continuous watchkeeping, minimum period of rest between watches and total daily, weekly and monthly hours of work; and
- (c) provide for a minimum period of ten hours of rest in a period of twenty-four hours, which may be divided into no more than two periods, one of which shall be at least six hours in length.

(6) Notwithstanding subregulation (5)(c), the minimum period of ten hours may be reduced to not less than six consecutive hours, on the condition that the reduction shall not extend beyond two days and not less than seventy hours of rest are provided in a period of seven days.

(7) The company shall consider the nature of the shipping operation and the voyages to be undertaken, in arranging the hours of work at sea and in port.

(8) The schedule may be changed by the company or by an employer who, by virtue of subregulation (3), is subject to the duties of the company, on the condition that—

- (a) other employers and where necessary the company, have been consulted;
- (b) the company or the employer has sought the views of the master on the proposed changes and the master has sought and conveyed to the company, the views of persons specified in subregulation (4)(a) or (b); and
- (c) the schedule as changed, complies with subregulation (5).

UNOFFICIAL VERSION

UPDATED TO 31ST DECEMBER 2016

(9) The company shall ensure that the schedule is displayed prominently in the crew accommodation for the information of all seafarers and that it is in a standardised format, in the common language of the ship and in English.

(10) The master shall ensure, as far as is reasonably practicable, that the hours of work specified in the schedule are not exceeded.

(11) The following requirements apply with respect to the schedule:

- (a) the company and the master shall maintain on board the ship, a copy of the schedule and a record of all deviations from its requirements;
- (b) the company shall ensure that a copy of the schedule and of the record of all deviations from its requirements are preserved for a period of five years from the date the schedule was introduced, and that they are available for inspection by the Registrar of Seamen, a proper officer, a surveyor or an inspector;
- (c) where, during the period of five years specified in paragraph (b), there ceases to be a company in relation to the ship, the duty to preserve the copies of the schedule and of the record shall remain with the last such company; and
- (d) the master shall give to a seafarer a copy of the schedule pertaining to the seafarer, which shall be signed by the master or a person authorised by the master, and by the seafarer.

(12) Musters, fire-fighting and lifeboat drills shall be conducted in a manner that minimises the disturbance of the periods of rest and does not induce fatigue.

(13) Where a seafarer is on call, such as where a machinery space is unattended, an adequate period of rest shall

LAWS OF TRINIDAD AND TOBAGO

MINISTRY OF THE ATTORNEY GENERAL AND LEGAL AFFAIRS

www.legalaffairs.gov.tt

852

Chap. 50:10

Shipping

[Subsidiary]

*Shipping (Training, Certification, Safe Manning, Hours of Work and Watchkeeping) Regulations*

be given to the seafarer where the normal period of rest is disturbed by call-outs to work.

(14) In this regulation and in regulation 38, “schedule” means the schedule of duties referred to in subregulation (1).

Exceptions for emergencies.

**38.** (1) The requirements for periods of rest specified in regulation 37(5)(c) and (6) need not be maintained in the case of—

- (a) an emergency, including giving assistance to a ship or a person in distress at sea;
- (b) a drill; or
- (c) any other overriding operational condition.

(2) Without prejudice to the generality of subregulation (1), a seafarer may participate in a navigational, engine room or machinery watch although he has not had the period of rest provided by the schedule and the master may exceed, and another seafarer may be required to exceed, the periods of work or duty specified in the schedule where, in the opinion of the master, it is necessary to meet an emergency threatening the safety of the ship, the life of a person or damage to the environment, until the emergency is over.

(3) As soon as practicable after the emergency is over, the master shall ensure that a seafarer who has performed work in a scheduled period of rest is provided with an adequate period of rest.

(4) Where a master or another seafarer has worked within a scheduled period of rest, his name shall be entered in the record required to be maintained under regulation 37(11), together with the reason that he so worked.

Failure to comply with provisions relating to hours of work and rest. [9/2012].

**39.** (1) Where the records or other evidence indicate a failure, on the part of a person concerned, to comply with the provisions of these Regulations relating to hours of work and rest, the Director

UNOFFICIAL VERSION

UPDATED TO 31ST DECEMBER 2016

shall take such measures as he may deem necessary to ensure that such failure to comply is not repeated.

(2) The measures referred to in this Regulation may include a revision of the safe manning requirements.

**40.** A copy of this Part and Part VI of these Regulations shall be kept on board a ship.

Duty to keep copy of Regulations.

#### PART VI

#### WATCHKEEPING

**41.** (1) The master of a ship shall ensure that the watchkeeping arrangements for the ship are at all times adequate for maintaining safe navigational and engineering watches in accordance with Regulation VIII of the Annex to the STCW Convention and section A-VIII/1 of the STCW Code.

Watchkeeping arrangements.

(2) Without prejudice to the duties of the master under subregulation (1), the master shall give directions to the deck watchkeeping officer responsible for navigating the ship safely during his period of duty, in accordance with Part 3–1 of section A-VIII/2 of the STCW Code and the guidelines specified in the Sixth Schedule.

Sixth Schedule.

(3) The chief engineer officer of a ship shall ensure that the engineering watchkeeping arrangements for the ship are at all times adequate for maintaining a safe watch, in accordance with Part 3–2 of section A-VIII/2 of the STCW Code and when deciding the composition of the watch, the chief engineer officer shall observe the principles specified in Part 3–2 of that section and the guidelines specified in the Sixth Schedule.

**42.** The master of a ship which is safely moored or safely at anchor under normal circumstances in port, shall arrange for an appropriate and effective watch to be maintained for the purposes of safety and the arrangements shall be in accordance with Part 4 of section A-VIII/2 of the STCW Code and the guidelines in the Sixth Schedule.

Watchkeeping arrangements in port.

Sixth Schedule.

LAWS OF TRINIDAD AND TOBAGO

MINISTRY OF THE ATTORNEY GENERAL AND LEGAL AFFAIRS

www.legalaffairs.gov.tt

854

Chap. 50:10

Shipping

[Subsidiary]

*Shipping (Training, Certification, Safe Manning, Hours of Work and Watchkeeping) Regulations*

Watchkeeping arrangements in port for ships carrying hazardous cargo. [9/2012].

**43.** (1) The master of a ship which is carrying hazardous cargo and which is in port, even when safely moored or safely at anchor, in addition to any watchkeeping arrangements required under regulation 42, shall ensure in the case of—

- (a) a ship carrying hazardous cargo in bulk, that a safe deck watch and safe engineering watch are maintained by the ready availability on board the ship, of a duly qualified officer or officers, and where appropriate, ratings; and
- (b) a ship carrying hazardous cargo other than in bulk, that in organising safe watchkeeping arrangements, he takes account of the nature, quality, packing and stowage of the hazardous cargo and of any special conditions on board, afloat and ashore.

Sixth Schedule.

(2) In making watchkeeping arrangements under subregulation (1), the master shall take full account of the guidelines specified in the Sixth Schedule and any additional guidance issued by the Director.

PART VII

MISCELLANEOUS

Prohibition on the employment of young persons.

**44.** (1) A person who has not attained sixteen years of age shall not be employed on a ship.

(2) A person who has not attained eighteen years of age shall not be employed as a trimmer or stoker on a ship.

(3) A seafarer who has not attained eighteen years of age shall not work at night.

(4) For the purposes of subregulation (3), “night” means a period of at least nine consecutive hours, including the period from midnight to 0500 hours.

Common language.

**45.** A common language, which need not be the English language, shall exist on board a Trinidad and Tobago ship to enable the effective communication among seafarers.

UNOFFICIAL VERSION

UPDATED TO 31ST DECEMBER 2016

**46.** (1) An authorised person may inspect a ship while in port in Trinidad and Tobago for the purposes of— Inspection of ships.

- (a) verifying that a seafarer serving on board who is required to be certificated, holds a certificate, an endorsement or a valid dispensation or has provided the documentary evidence or proof, required by these Regulations or the STCW Convention, as the case may be;
- (b) verifying that the numbers and certificates of the seafarers serving on board are in conformity with the applicable safe manning requirements; and
- (c) assessing the ability of the seafarers on board the ship, to maintain the watchkeeping standards required by these Regulations, where, while in a port or in the approaches to the port—
  - (i) the ship has been in a collision, grounded or stranded;
  - (ii) there has been an unlawful discharge of substances from the ship when underway, at anchor or at a berth;
  - (iii) the ship has been manoeuvred in an erratic or unsafe manner, or navigational course markers or traffic separation schemes have not been followed; or
  - (iv) the ship has otherwise been operated in such a manner as to pose a danger to persons, property or the environment.

(2) An authorised person who finds on inspection, a deficiency of a kind specified in subregulation (3), shall notify in writing, the master of the ship and in the case of a foreign ship, the nearest maritime consular or diplomatic representative of the flag state.

- (3) Deficiencies referred to in subregulation (2) are—
- (a) a failure of a seafarer required to hold a certificate, an endorsement or a dispensation;

LAWS OF TRINIDAD AND TOBAGO

MINISTRY OF THE ATTORNEY GENERAL AND LEGAL AFFAIRS

www.legalaffairs.gov.tt

856

Chap. 50:10

Shipping

[Subsidiary]

*Shipping (Training, Certification, Safe Manning, Hours of Work and Watchkeeping) Regulations*

- (b) a failure of a seafarer to produce the documentary evidence or proof, required by these Regulations or the STCW Convention, as the case may be;
- (c) a failure to comply with the applicable safe manning requirements;
- (d) a failure of navigational or engineering watch arrangements to conform to the requirements specified for the ship by the competent authority of the country in which the ship is registered;
- (e) an absence on a watch, of a seafarer qualified to operate equipment essential to safe navigation, safety radio communications or the prevention of marine pollution; and
- (f) an inability of the master to provide adequately rested seafarer for the first watch at the commencement of a voyage and for subsequent relieving watches.

(4) A certificate, an endorsement or a dispensation referred to in subregulation (1), shall be accepted by the authorised person carrying out the inspection unless there are reasonable grounds for believing that it has been fraudulently obtained or that it is not held by the seafarer to whom it was issued.

Power to detain.

**47.** Where it is found—

- (a) in relation to a Trinidad and Tobago ship, that there is any contravention of these Regulations; or
- (b) in relation to a foreign ship, that there is—
  - (i) a contravention of regulation 28, 41, 42 or 43; or
  - (ii) a failure to correct a deficiency of a kind specified in regulation 46(3), after notification to the master pursuant to

UNOFFICIAL VERSION

UPDATED TO 31ST DECEMBER 2016

regulation 46(2), and there is in consequence, a danger to persons, property or the environment,

the ship may be detained and section 387 of the Act shall apply to the detention.

**48.** Regulations 46 and 47 shall be applied as may be necessary to ensure that no more favourable treatment is given to non-STCW ships than is given to STCW ships.

Parity of treatment of STCW ships and non-STCW ships.

**49.** (1) A company which contravenes regulation 26(1) or (3), 28(2), 29(3), 37(1), (2), (8) or (11) or fails to ensure that original certificates and other documents issued pursuant to these Regulations or the STCW Convention, indicating the qualification of a seafarer to perform required functions on a ship, are kept on board the ship, commits an offence and is liable on conviction to a fine of thirty thousand dollars or imprisonment for twelve months, or both.

Penalties.

(2) A master who contravenes regulation 26(5), 28(3), 38(2), 41(1) or (2), 42, 43 or fails to ensure that original certificates and other documents issued pursuant to these Regulations or the STCW Convention, indicating the qualification of a seafarer to perform required functions on a ship, are kept on board the ship, commits an offence and is liable on conviction to a fine of thirty thousand dollars or imprisonment for twelve months or both.

(3) A member of the crew who contravenes regulation 26(5) commits an offence and is liable on conviction to a fine of eighteen thousand dollars.

(4) A chief engineer officer who contravenes regulation 41(3) commits an offence and is liable on conviction to a fine of thirty thousand dollars.

(5) A company which contravenes regulation 35(1) commits an offence and is liable on conviction to a fine of thirty thousand dollars.

LAWS OF TRINIDAD AND TOBAGO

MINISTRY OF THE ATTORNEY GENERAL AND LEGAL AFFAIRS

www.legalaffairs.gov.tt

858

Chap. 50:10

Shipping

[Subsidiary]

*Shipping (Training, Certification, Safe Manning, Hours of Work and Watchkeeping) Regulations*

(6) An employer who contravenes regulation 35(1) commits an offence and is liable on conviction to a fine of thirty thousand dollars.

(7) A master who contravenes regulation 36 or 37(10) or (11) commits an offence and is liable on conviction to a fine of six thousand dollars.

(8) A seafarer who contravenes regulation 36 commits an offence and is liable on conviction to a fine of six thousand dollars.

(9) It shall be a defence for a person charged with an offence under these Regulations to prove that he took all reasonable steps to avoid the commission of the offence.

(10) In proceedings for an offence under these Regulations consisting of a failure to comply with a duty or requirement to do something so far as is reasonably practicable, it shall be for the accused to prove that it was not reasonably practicable to do more than was in fact done to satisfy the duty or requirement.

Exemptions.  
[9/2012].

**50.** The Director may grant, on such terms as he may specify, exemptions from all or any provisions of these Regulations to a person or class of person.

Fees.  
Eighth  
Schedule.  
[9/2012].

**51.** The fees prescribed in the Eighth Schedule shall be paid in respect of the examinations and documents specified therein.

LN No. 248 of  
2001 is revoked.  
[9/2012].

**52.** The Shipping (Certification of Seamen) (Engine Room Ratings) Regulations, 2001 are revoked.

LN No. 254 of  
2001 is revoked.  
[9/2012].

**53.** The Shipping (Certification of Seamen) (Deck Ratings) Regulations, 2001 are revoked.

---

UNOFFICIAL VERSION

UPDATED TO 31ST DECEMBER 2016

**FIRST SCHEDULE**

Regulation 2.  
[9/2012].

**CARIBBEAN TRADING AREA**

In these Regulations “the Caribbean Trading Area” means the area bounded by the East coasts of North, Central and South America and a line from the East coast of the United States of America in latitude 32° 30'N to a point 20°N: 60°W, to a point 10°N : 50°W, and South to the coast of South America, illustrated on the map below—

**CARIBBEAN TRADING AREA**

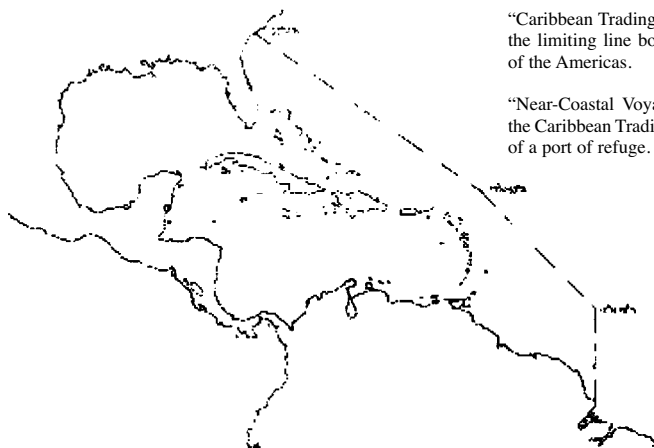

“Caribbean Trading Area” is the area within the limiting line bounded by the East coast of the Americas.

“Near-Coastal Voyage” is a voyage within the Caribbean Trading Area within 150 miles of a port of refuge.

**LAWS OF TRINIDAD AND TOBAGO**

MINISTRY OF THE ATTORNEY GENERAL AND LEGAL AFFAIRS

www.legalaffairs.gov.tt

860

**Chap. 50:10**

*Shipping*

**[Subsidiary]**

*Shipping (Training, Certification, Safe Manning, Hours of Work  
and Watchkeeping) Regulations*

Regulation  
3D(2).  
[9/2012].

**SECOND SCHEDULE**

**PART A**

**RECORD OF CERTIFICATES AND ENDORSEMENTS**

1. In implementing the requirement in paragraph 4.1 of regulation I/9 of the revised STCW Convention for the maintenance of a register of certificates and endorsements, a standard database is not necessary provided that all the relevant information is recorded and available.

2. The following items of information should be recorded and available either on paper or electronically in accordance with regulation I/9, as a minimum:

(1) Status of Certificate—

Valid  
Suspended  
Cancelled  
Reported lost  
Destroyed

with a record of changes to status to be kept, including dates of changes.

(2) Certificate details—

Seafarers name  
Date of birth  
Nationality  
Sex  
Preferably a photograph  
Relevant document number  
Date of Issue  
Date of expiry  
Last revalidation date  
Details of dispensation(s)

(3) Competence details—

STCW Competence standard (e.g., regulation II/1)  
Capacity  
Function  
Level of responsibility  
Endorsements  
Limitations

(4) Medical details—

Date of issue of latest medical certificate relating to the issue or revalidation of the appropriate certificate.

UNOFFICIAL VERSION

UPDATED TO 31ST DECEMBER 2016



REPUBLIC OF TRINIDAD AND TOBAGO

**FORM OF ENDORSEMENT ATTESTING THE  
RECOGNITION OF A CERTIFICATE**

Regulation 7(5).

**PART B**

ENDORSEMENT ATTESTING THE RECOGNITION OF A CERTIFICATE  
UNDER THE PROVISIONS OF THE SHIPPING ACT, CH. 50:10, GIVING  
EFFECT TO THE INTERNATIONAL CONVENTION ON STANDARDS  
OF TRAINING, CERTIFICATION AND WATCHKEEPING FOR  
SEAFARERS, 1978, AS AMENDED IN 1995

The Government of the Republic of Trinidad and Tobago certifies that Certificate  
No..... issued to ..... by or on behalf  
of the Government of..... is duly recognised in accordance  
with the provisions of regulation I/10 of the above Convention, as amended in 1995,  
and the holder is authorised to perform the following functions, at the levels specified,  
subject to any limitations indicated until ..... or until the date of expiry  
of any extension of the validity of this endorsement:

Function	Level	Limitations (If any)

The lawful holder of this endorsement may serve in the following capacity or capacities  
specified in the applicable safe manning requirements of the Maritime Services Division:

Capacity	Limitations (If any)

LAWS OF TRINIDAD AND TOBAGO

MINISTRY OF THE ATTORNEY GENERAL AND LEGAL AFFAIRS

www.legalaffairs.gov.tt

862

Chap. 50:10

Shipping

[Subsidiary]

Shipping (Training, Certification, Safe Manning, Hours of Work and Watchkeeping) Regulations

Endorsement No. .... issued on ...../...../..... (dd / mm / yy)

(Official Seal)

Signature of duly authorised official

Name of duly authorised official

The original of this endorsement must be kept available in accordance with Regulation I/2, paragraph 9 of the above Convention while the holder is serving on a ship.

Date of birth of the holder of the certificate ...../...../..... ( dd / mm / yy )

Photograph of holder

Signature of the holder of the certificate .....

The validity of this endorsement is hereby extended to .....

(Official Seal)

Signature of duly authorised official

Date of revalidation .....

Name of duly authorised official

The validity of this endorsement is hereby extended to .....

(Official Seal)

Signature of duly authorised official

Date of revalidation .....

Name of duly authorised official

The validity of this endorsement is hereby extended to .....

(Official Seal)

Signature of duly authorised official

Date of revalidation .....

Name of duly authorised official

The validity of this endorsement is hereby extended to .....

(Official Seal)

Signature of duly authorised official

Date of revalidation .....

Name of duly authorised official

UNOFFICIAL VERSION

UPDATED TO 31ST DECEMBER 2016

**THIRD SCHEDULE**

Regulation  
7(6).

**KNOWLEDGE OF THE MARITIME LEGISLATION OF  
TRINIDAD AND TOBAGO AND PROFICIENCY IN THE  
ENGLISH LANGUAGE**

1. (1) A seafarer at management level shall have sufficient knowledge of the legal and administrative procedures applicable to a Trinidad and Tobago ship to enable him to operate a ship safely and efficiently.

Seafarers at management level to have knowledge of the maritime legislation of Trinidad and Tobago.

(2) A seafarer who satisfies the Minister that he has sufficient knowledge of the legal and administrative procedures referred to in subregulation (1) shall not be required to be assessed by a written examination.

(3) A seafarer who fails to satisfy the Minister that he has sufficient knowledge of the legal and administrative procedures referred to in subclause (1) shall be assessed by a written examination, which may include the examination of English language skills referred to in clause 4(b).

2. A seafarer at management or operational level, shall irrespective of the common language of the ship, have an appropriate level of proficiency in the English language, commensurate with the functions the seafarer is permitted to perform.

Seafarers at certain levels required to have an appropriate level of proficiency in English Language.

3. Where—

- (a) the Minister is satisfied based on the seafarer's certificate, that the seafarer was satisfactorily tested in oral and written English language skills; or
- (b) the seafarer provides other evidence of his proficiency in the English language,

Evidence of proficiency in English Language.

the seafarer shall not be required to be assessed under clause 4.

4. Where the Minister is not satisfied or the seafarer does not provide evidence, under clause 3, the seafarer shall undergo—

Examination for proficiency in English Language.

- (a) a standard, oral examination to assess the ability of the seafarer to speak and comprehend English; and
- (b) a standard, written examination to assess the ability of the seafarer to write English.

5. An examination referred to in clauses 1 and 4 may be taken by prior arrangement through the Maritime Services Division, or under other arrangements as may be approved by the Minister.

Arrangement for examinations.

## FOURTH SCHEDULE

## ISSUE OF CERTIFICATES OF COMPETENCE

1. Candidates seeking to be certificated (in any capacity, function or level) must—

- (a) provide proof of their identity and nationality;
- (b) provide proof of the sufficiency of their age;
- (c) hold a valid certificate of medical fitness (inclusive of sight and hearing tests);
- (d) have completed the required period of watchkeeping or seagoing service;
- (e) have successfully completed the required course of compulsory training. In this regard they should provide transcripts from an approved training institution attesting that they have successfully completed the course of study;
- (f) meet the required standards of competence or have successfully completed the prescribed assessment, as appropriate;
- (g) provide testimonials as to their character, including sobriety, and a record of suitable experience and satisfactory conduct during the period of seagoing service; and
- (h) provide a Certificate of Good Character from the country in which they have officially resided during the three (3) year period immediately preceding the date of the application,

and the Director may waive the requirement at paragraph (h) where, within a period of two (2) years immediately preceding the application, a Certificate of Good Character had been provided in connection with a previous application for certification.

2. Candidates seeking initial certification as watchkeeping officers are required, in addition to the above-mentioned requirements, to produce a training record book, attesting to the fact that they have completed a period of systematic, practical training and experience in the tasks, duties and responsibilities of an officer in charge of a watch.

3. The Director will issue certificates of competence only to those candidates who meet the requirements appropriate to the capacity, function and level of responsibility for which they seek to be certificated.

4. Certificates of competence issued by the Director shall be in the form specified in the Annex to this Schedule.

5. Any certificate of competence issued by the Director must be kept by the lawful holder in its original form onboard the ship on which they are serving.



Republic of Trinidad and Tobago

**ANNEX 1**

**CERTIFICATE ISSUED UNDER THE PROVISIONS  
OF THE SHIPPING ACT, 1987 GIVING EFFECT  
TO THE INTERNATIONAL CONVENTION ON  
STANDARDS OF TRAINING, CERTIFICATION  
AND WATCH-KEEPING FOR SEAFARERS, 1978  
AS AMENDED IN 1995**

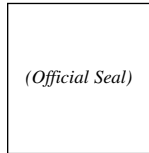

The Government of the Republic of Trinidad and Tobago certifies that ..... has been found duly qualified in accordance with the provisions of Regulation ..... of the above Convention, as amended, and has been found competent to perform the following functions, at the levels specified, subject to any limitations indicated until ..... or until the date of expiry of any extension of the validity of the certificate as may be shown overleaf:

FUNCTION	LEVEL	LIMITATIONS APPLYING (IF ANY)

**LAWS OF TRINIDAD AND TOBAGO**

MINISTRY OF THE ATTORNEY GENERAL AND LEGAL AFFAIRS

www.legalaffairs.gov.tt

866

**Chap. 50:10**

*Shipping*

[Subsidiary]

*Shipping (Training, Certification, Safe Manning, Hours of Work and Watchkeeping) Regulations*

The lawful holder of this certificate may serve in the following capacity or capacities specified in the applicable safe manning requirements of the Maritime Services Division:

CAPACITY	LIMITATIONS APPLYING (IF ANY)

Certificate No. ....

Issued on .....

*(Official Seal)*

.....  
*Signature of duly authorised official*

.....  
*Name of duly authorised official*

The original of this certificate must be kept in accordance with regulation I/2, paragraph 9 of the Convention while serving on a ship.

Date of birth of holder of the certificate .....

Signature of the holder of the certificate .....

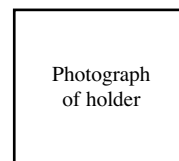

UNOFFICIAL VERSION

UPDATED TO 31ST DECEMBER 2016

The validity of this certificate is hereby extended until .....	
<i>(Official Seal)</i> .....	..... <i>Signature of duly authorised official</i>
Date of revalidation .....	..... <i>Name of duly authorised official</i>
The validity of this certificate is hereby extended until .....	
<i>(Official Seal)</i> .....	..... <i>Signature of duly authorised official</i>
Date of revalidation .....	..... <i>Name of duly authorised official</i>
The validity of this certificate is hereby extended until .....	
<i>(Official Seal)</i> .....	..... <i>Signature of duly authorised official</i>
Date of revalidation .....	..... <i>Name of duly authorised official</i>
The validity of this certificate is hereby extended until .....	
<i>(Official Seal)</i> .....	..... <i>Signature of duly authorised official</i>
Date of revalidation .....	..... <i>Name of duly authorised official</i>

**LAWS OF TRINIDAD AND TOBAGO**

MINISTRY OF THE ATTORNEY GENERAL AND LEGAL AFFAIRS

www.legalaffairs.gov.tt

868

**Chap. 50:10**

*Shipping*

**[Subsidiary]**

*Shipping (Training, Certification, Safe Manning, Hours of Work and Watchkeeping) Regulations*



Republic of Trinidad and Tobago



**CERTIFICATE ISSUED UNDER THE PROVISIONS OF THE SHIPPING ACT, 1987, GIVING EFFECT TO THE INTERNATIONAL CONVENTION ON STANDARDS OF TRAINING, CERTIFICATION AND WATCHKEEPING FOR SEAFARERS, 1978 AS AMENDED IN 1995**

The Government of the Republic of Trinidad and Tobago certifies that ..... has been found duly qualified in

accordance with the provisions of regulation ..... of the above Convention, as amended, *[to be proficient in survival craft and rescue boats/\*other than fast rescue boats] [to serve on tankers] [to serve as navigation/\*engine room watch rating].*

Certificate No. .... Issued on .....

*(Official Seal)*

.....  
*Signature of duly authorised official*

.....  
*Name of duly authorised official*

The original of this certificate must be kept in accordance with regulation I/2, paragraph 9 of the Convention while serving on a ship.

Date of birth of holder of the certificate .....

Signature of the holder of the certificate .....

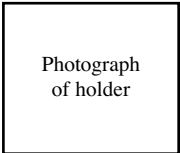

UNOFFICIAL VERSION

UPDATED TO 31ST DECEMBER 2016

**FIFTH SCHEDULE**

Regulation  
14A.  
[9/2012].

**TRAINING AND CERTIFICATION OF OFFICERS AND  
CREW ON HIGH SPEED CRAFT**

**1. Training Requirements**

- 1.1 Deck officers serving on High Speed Craft (HSC) are required to hold a Type Rating Certificate (TRC) in addition to a valid deck officer certificate of competency.
- 1.2 HSC operators are responsible for ensuring that the appropriate training is given to deck officers so that they may qualify for the issue of a TRC. The training required by the HSC Code includes knowledge of the craft's propulsion and control system, handling characteristics, communication and navigation procedures, intact stability and survivability of the craft.
- 1.3 Organisations providing TRC training shall be required to nominate a person responsible for the training. This person shall be designated as the Type Rating Instructor (TRI). TRIs may be appointed from within the HSC operating organisation or from an outside source. Organisations shall also nominate another person responsible for the assessment of training to serve as a Type Rating Examiner (TRE). Both TRIs and TREs shall be experienced in the operation of the craft on the route on which they shall be instructing and examining, respectively, and be approved by the Director. Under no circumstances shall the same person be allowed to work as both TRI and TRE.
- 1.4 Engineer officers on HSC shall be required to be appropriately certified under the requirements of these Regulations but do not require type rating certification.
- 1.5 On HSC with gas turbine propulsion, engineer officers may hold a Motor, Steam or Combined certificates of competency. In addition, specified senior engineer officers are required to hold a certificate attesting to the completion of an approved gas turbine training programme for the machinery on their vessel.

# LAWS OF TRINIDAD AND TOBAGO

MINISTRY OF THE ATTORNEY GENERAL AND LEGAL AFFAIRS

www.legalaffairs.gov.tt

870

**Chap. 50:10**

*Shipping*

[Subsidiary]

*Shipping (Training, Certification, Safe Manning, Hours of Work and Watchkeeping) Regulations*

## **2. Issue of type Rating Certificates**

- 2.1 After undergoing training with the approved TRI, a candidate shall be examined by the approved TRE. Where successful, the organisation shall issue a TRC in the form set out in the Annex. The TRC, plus a duplicate copy, shall be forwarded together with a valid medical fitness certificate to the Maritime Services Division. The TRC shall specify the craft or class of craft (e.g., a 65-metre wave piecing catamaran), and its operational area or routes.
- 2.2 If the Director is satisfied that all the requirements have been met, he shall endorse the TRC for service use. This procedure is required in order to satisfy the requirements of paragraph 18.3.3 of the HSC Code. The Director shall return the original and keep the duplicate copy for record purposes.
- 2.3 Further routes may be added to a TRC after a holder has undergone route familiarisation training and performance assessment by the TRE. The organisation may issue a new TRC or amend an existing one upon the recommendation of the TRE. In any case, the TRC shall be submitted to the Maritime Services Division for endorsement of the amendments and for recording purposes as above.

## **3. Revalidation**

- 3.1 Revalidation of a TRC is required at intervals of not more than two years. For revalidation, candidates shall be required to show evidence of continuing fitness for service on HSC. They shall be required to show evidence of at least six months sea service on HSC in the preceding two years or a statement from a HSC operator or other TRC training organisation to indicate that the candidate has successfully completed a training programme prior to seeking revalidation. When the issuing organisation is satisfied that the revalidation requirements have been met, the TRC shall be revalidated (*see* reverse side of specimen certificate format in the Annex) and submitted to the Maritime Services Division for endorsement and recording purposes.

## **4. Ratings and other Personnel**

Ratings and other personnel employed on HSC shall undergo a training programme appropriate to their duties on board and may be

UNOFFICIAL VERSION

UPDATED TO 31ST DECEMBER 2016

trained solely for HSC service without seagoing experience on other types of ships. Ratings in this category may hold a certificate as a Deck Rating EDH limited for service on HSC as appropriate. This limitation shall be removed when the holder applies for at least six months service on a conventional ship. Application for removal of a limitation shall be made to the Maritime Services Division.

#### **5. Non Sea-going HSC**

Deck officer on non-sea-going HSC shall be required to follow a training, assessment and certification system similar to that detailed above. In order to qualify for a TRC, the applicant shall be required to demonstrate the skills appropriate to navigational duties in the relevant operational areas.

---

**LAWS OF TRINIDAD AND TOBAGO**

MINISTRY OF THE ATTORNEY GENERAL AND LEGAL AFFAIRS

www.legalaffairs.gov.tt

872

**Chap. 50:10**

*Shipping*

**[Subsidiary]**

*Shipping (Training, Certification, Safe Manning, Hours of Work and Watchkeeping) Regulations*

Regulation  
29(3).  
[9/2012].

**SIXTH SCHEDULE**

**SAFE MANNING, HOURS OF WORK AND  
WATCHKEEPING**

**SAFE MANNING**

**1. INTRODUCTION**

- 1.1 This Schedule places clear responsibilities on companies owning or operating in Trinidad and Tobago sea-going ships, and other ships whilst in Trinidad and Tobago waters, to ensure that their ships are manned with personnel of appropriate grades who have been properly trained and certificated, and who are in possession of an appropriate certificate or endorsement or have applied for such an endorsement in accordance with regulation 6.
- 1.2 The numbers of certificated officers and certificated and non-certificated ratings shall be sufficient to ensure safe and efficient operation of the ship at all times.
- 1.3 All ships of 500 GT or more shall be required to hold a safe manning document and owners or operators of ships below 500 GT may also be required to hold a safe manning document.
- 1.4 The owner or operator of a Trinidad and Tobago ship shall be required to make an assessment of the numbers and grades of personnel necessary for safe operation. Such numbers and grades shall be sufficient to ensure that—
  - (a) the required watchkeeping standard can be maintained and that personnel are able to obtain sufficient rest;
  - (b) personnel are not required to work more hours than is safe in relation to the safety of the ship;
  - (c) the master and seafarers can perform their duties in accordance with the framework of operational guidance in section A-VIII of the STCW Code; and
  - (d) the master and seafarers are not required to work such hours or under such conditions which may be injurious to their health and safety.
- 1.5 All proposals based on the above assessment shall be submitted to the Director who, when satisfied that the proposed manning levels are adequate, will issue a safe manning document.

UNOFFICIAL VERSION

UPDATED TO 31ST DECEMBER 2016

## **1.2 Safe Manning**

- 1.2.1 The responsibility to ensure that ships are safely, sufficiently and efficiently manned rests with the owners and managing operators. Guidance on determining appropriate manning levels is given in section 2.
- 1.2.2 In order to avoid possible problems at a later stage, owners and operators are recommended to consult with seafarers or their representatives and the Director on their proposed manning when new ships are at the design stage and in advance of registering existing ships in Trinidad and Tobago.
- 1.2.3 In the event of any disagreement between the owners and seafarers or their representatives regarding manning levels, the Director shall consider any views put forward and may require a revision of the manning levels, where so justified. In such cases it may be necessary to arrange for some form of practical demonstration of the ability of the crew to carry out the essential tasks in the context of the principles of safe manning. Similarly, in the event of any change in the equipment, construction or use of the ship which may affect the safe manning level, the owner or operator should make an application for the issue of a new safe manning document.

## **1.3 Specialist ship types**

- 1.3.1 Offshore support vessels present special problems because of the diverse nature of their operations and the conditions under which they are required to operate. Owners are particularly reminded of the restrictions placed on working hours under the Regulations and should set manning levels accordingly.
- 1.3.2 Ship owners and operators must ensure that the master, officers and ratings on tankers, and the master, officers, ratings and other personnel on passenger ships including ro-ro passenger ships have completed the training required by the Regulations which is specified in sections A-V/1 and A-V/2 of the STCW Code. All crew members on high speed craft must have completed the training required under the HSC Code, and masters and officers having an operational role must hold a Type Rating Certificate as required by the HSC Code. On passenger ships generally, the need to handle large numbers of passengers unfamiliar with the marine environment must be taken into account in determining manning levels. Personnel should be appropriately trained and certificated and owners and operators must give particularly careful attention to the requirements for minimum numbers of trained crew to take charge of survival craft.

#### 1.4 Safe manning document

When the Director has agreed to proposals regarding the manning of a particular ship, a safe manning document shall be issued for that ship in a format which complies with the requirements of the SOLAS Convention. It should be retained on board and be available for inspection whenever required by an authorised person.

### 2. DETERMINATION OF SAFE MANNING LEVELS

#### 2.1 Principles

2.1.1 The Director shall consider a ship to be safely manned where the crew includes sufficient officers and ratings with appropriate skills and experience to ensure that the following capabilities are available; these reflect principles in IMO Resolution A.481 (XII), which should be consulted when determining safe manning levels:

- (a) to maintain a safe bridge watch at sea in accordance with regulation VIII/2 of STCW 95, which includes general surveillance of the vessel;
- (b) to moor and unmoor a vessel effectively and safely;
- (c) to operate and maintain effectively all watertight closing arrangements including the ability to mount an effective damage control party;
- (d) to operate and, when practicable, maintain efficiently, all fire equipment and lifesaving appliances provided including the ability to muster and disembark passengers and non-essential personnel;
- (e) to manage the safety functions of a vessel at sea, when not under way;
- (f) to maintain a safe engineering watch at sea in accordance with regulation VIII/2 of STCW 95, and also maintain general surveillance of spaces containing main propulsion and auxiliary machinery;
- (g) to operate and maintain in a safe condition the main propulsion and auxiliary machinery to enable the ship to overcome the foreseeable perils of the voyage;
- (h) to maintain the safety arrangements and the cleanliness of machinery spaces to minimise the risk of fire;
- (i) to provide for medical care on board ship;
- (j) to maintain a safe radio watch in accordance with the SOLAS Convention and ITU regulations, as amended;

- (k) to maintain the precautions and safeguards necessary to protect the marine environment in accordance with MARPOL 73/78 as amended; and
- (l) to maintain safety in all ship operations whilst in port.

## **2.2 Establishing safe manning requirements**

2.2.1 The Director shall require all ships to be sufficiently and efficiently manned for their safe operation, having regard to the nature of their work and their location. To ensure safe and efficient operation, a minimum level of manning shall be determined. To make that assessment, owners and operators should take account of the following factors:

- (a) the length and nature of voyage and trading area;
- (b) any special requirements of the trade involved;
- (c) number, size (kW) and type of main propulsion units and auxiliaries;
- (d) size of the ship (GT); and
- (e) construction and technical equipment of ship.

2.2.2 In conjunction with these factors, the IMO principles of safe manning (*see* paragraph 2.1) and the need to ensure that personnel do not work more hours than is safe, the owner or operator shall—

- (a) identify all the functions to be undertaken on board during a representative voyage;
- (b) identify the skills and experience required to perform those functions;
- (c) identify those functions in normal operations which need to be undertaken concurrently;
- (d) determine the minimum numbers of personnel required to undertake concurrent operations safely;
- (e) establish working arrangements, including—in accordance with regulation 13 of Chapter V of the SOLAS Convention—the establishment of a working language on a passenger ship, to ensure the master and crew are capable of undertaking concurrent and continuing operations with respect to their skills and training; and
- (f) ensure that the working arrangements allow for sufficient rest periods to avoid fatigue and draw up work schedules accordingly.

## **2.3 Guidance on appropriate manning levels**

2.3.1 The Tables annexed hereto shall provide guidance on the numbers of certificated deck and engineer officers appropriate to different sizes

# LAWS OF TRINIDAD AND TOBAGO

MINISTRY OF THE ATTORNEY GENERAL AND LEGAL AFFAIRS

www.legalaffairs.gov.tt

876

**Chap. 50:10**

*Shipping*

[Subsidiary]

*Shipping (Training, Certification, Safe Manning, Hours of Work and Watchkeeping) Regulations*

of ships, tonnages and trading areas. As the watchkeeping arrangements for the engineering department and the demands placed on personnel vary significantly according to the level of automation, numbers are not given for engineer officers. These tables only provide guidance; owners and operators must take all relevant factors into account before finalising their manning proposals.

2.3.2 The number of ratings required will be determined by the factors summarised at paragraph 2.2. Owners and operators should additionally seek to obtain a good balance between skilled and less skilled and between experienced and less experienced ratings.

## **2.4 Watchkeeping**

2.4.1 The regulations require the master of any ship to be responsible for the overall safety of the ship. He must also ensure that the watchkeeping arrangements are adequate for maintaining safe navigational watches at all times, including the provision of a lookout as required by the International Regulations for the Prevention of Collisions at Sea, 1972, as amended. The chief engineer officer of any ship is required to ensure that the engineering watch arrangements for the ship are adequate at all times for maintaining a safe engineering watch.

2.4.2 The principles applying to the keeping of a safe watch are in section A-VIII/2 of the STCW Code and must be followed in order to comply with these Regulations.

## **3. HOURS OF WORK**

### **3.1 Working arrangements**

3.1.1 Every operator of a ship and employer shall ensure that the master, officers and ratings do not work more hours than is safe in relation to the performance of their duties and the safety of the vessel. The same responsibility is placed on the master in relation to the seafarers. Manning levels shall be such as to ensure so far as possible that the time and place available for taking rest periods are appropriate for achieving a good quality of rest. Operators will also want to take into account section B-VIII/1 of the STCW Code which provides further guidance about fitness for duty.

3.1.2 Operators shall be required to ensure that a schedule of duties is produced setting out the hours of work and the rest periods. The

UNOFFICIAL VERSION

UPDATED TO 31ST DECEMBER 2016

schedule shall provide that the master, officers and all other seafarers do not work more hours than is safe in relation to the safety of the ship. In devising the schedule, operators shall take account of factors such as—

- (a) trade and type of operation;
- (b) type and size of ship;
- (c) construction and technical equipment of ship;
- (d) manning levels and changes in crew numbers due to crew changes and sickness;
- (e) maximum period of continuous watchkeeping;
- (f) minimum rest periods;
- (g) total workload; and
- (h) the seriousness of irregular working hours and their contribution to fatigue causation and the importance of scheduling reasonably stable watchkeeping hours over a voyage.

3.1.3 Changes shall not be made to the schedule unless they can be justified by substantially altered work patterns made necessary, for example, by a change in trading pattern or other significant factor. Where it is known that a vessel engages in an irregular trading pattern or that working hours are likely to be uniform, this may be taken into account and recorded in the schedule. The consultation process referred to in paragraph 3.2 shall also apply to changes in the schedule.

### **3.2 Consultation**

Operators of ships are required to seek the views of the master when first drawing up a schedule of duties for a ship or ships. The master of a ship should seek the views of his officers and shall seek and convey to the operator the views of the seafarers or their representatives or a trade union, as appropriate. The final decision on the schedule rests with the operator who will have the responsibility to ensure that the schedule is safe in relation to the safety of the ship and the performance of duties. The master must ensure that, as far as reasonably practicable, the schedule is adhered to. Of course, in an emergency or when unforeseeable events occur, changes may well be unavoidable. Regulation 33(9) requires that, once a schedule has been completed by the operator, it must be displayed prominently in the crew accommodation on board the vessel for the information of all the seafarers.

### 3.3 Records

- 3.3.1 A record of all deviations from the schedules requirements shall be kept on the ship. Any suitable form of record is acceptable provided that the record is always accessible to those authorised to carry out inspections; the record must be retained for a period of up to five years. There shall be no need to rewrite the schedule for each voyage so long as it is applicable to the voyage in question and the composition of the crew for whom it was originally intended has not changed.
- 3.3.2 The overriding aim is to ensure that a proper record of agreed work patterns exists on board for the benefit of crew members and inspecting authorities, and that the record may be matched to each individual crew member involved by means of other documents such as the crew list.

### 3.4 Exceptions for emergencies

This Schedule recognises that situations may arise in which a master or seafarer may be required to exceed the scheduled duty periods. These include emergencies which threaten the safety of the ship or the environment or put life at risk. Where a master or other seafarer exceeds the scheduled hours of work in this manner, and has worked during his rest period, his name must be entered in the record required to be maintained, together with the reason for the excess.

## 4. APPLICATION FOR A SAFE MANNING DOCUMENT

### 4.1 Information to be provided

- 4.1.1 When applying to the Minister for a safe manning document, owners or operators shall submit a clear and concise explanation of how the proposed manning level has been determined and how it takes account of the guidance in paragraphs 2 and 3 above and the hours of work provisions in the regulations. The Minister will be able to make a quick assessment of the application where the owner or operator can demonstrate that all the factors and principles in those paragraphs have been taken into account.
- 4.1.2 Applications for a safe manning document should be made by the owner or a person authorised to act on his behalf, (on a form which is obtainable from the Maritime Services Division and which sets out the information required). An appropriate fee is payable with respect to the application.

ANNEX 1

GUIDANCE ON MINIMUM MANNING LEVELS  
 CERTIFICATED DECK OFFICERS

TABLE 1: DECK DEPARTMENT

UNLIMITED TRADE					
OFFICER RANK (STCW)	OFFICER GROSS TONNAGE PARAMETERS (STCW)	STCW REFERENCE	GROSS TONNAGE OF SHIP AND MINIMUM DECK OFFICER MANNING		
			≥3000	≥500 BUT <3000	≥500
Master	≥3000	II/2	1	—	—
Master	≥500 but ≤3000	II/2	—	1	1
Chief Mate	≥3000	II/2	1	—	—
Chief Mate	≥500 but ≥3000	II/2	—	1	—
OOW	≥500	II/1	2(a)	1(a)	2(a)(b)
NEAR COASTAL TRADE					
Master	≥3000	II/2	1	—	—
Master	500 but <3000	II/2	—	1	—
Master	<500	II/3	—	—	1
Chief Mate	≥3000	II/2	1	—	—
Chief Mate	≥500 but <3000	II/2	—	1	—
OOW	≥500	II/1	1(a)	1(a)	—
OOW	<500	II/3	—	—	1
OOW—Officer in charge of a navigational watch— (a) this requirement may be reduced by one if the master keeps a watch or where the length of voyage is short enough and the level of port activity low enough to ensure adequate rest for the watchkeepers. (b) the Officer designated as Chief Mate must have at least six months experience whilst holding STCW II/1 certification.					

Additional Notes—

All Navigational Watch Ratings are to be qualified in accordance with STCW II/4.

The above levels are for guidance only and actual levels will vary according to the type, size, age and trading pattern of the vessels.

**LAWS OF TRINIDAD AND TOBAGO**

MINISTRY OF THE ATTORNEY GENERAL AND LEGAL AFFAIRS

www.legalaffairs.gov.tt

880

**Chap. 50:10**

*Shipping*

**[Subsidiary]**

*Shipping (Training, Certification, Safe Manning, Hours of Work and Watchkeeping) Regulations*

**GUIDANCE ON MINIMUM MANNING LEVELS  
CERTIFICATED ENGINEER OFFICERS**

**TABLE 2: ENGINE DEPARTMENT**

UNLIMITED TRADE					
OFFICER RANK (STCW)	OFFICER ENGINE POWER PARAMETERS (STCW)	STCW REFERENCE	ENGINE POWER OF SHIPS IN KILOWATTS (kW) AND MINIMUM ENGINEER OFFICER MANNING		
			≥3000	≥750 BUT <3000	≥350 BUT <750
Ch. Engineer	≥3000	III/2	1	—	—
Ch. Engineer	≥750 but <3000	III/3	—	1	1(b)
2nd Engineer	≥3000	III/2	1	—	—
2nd Engineer	≥750 but <3000	III/3	—	1	—
OOW	≥3000	III/1	2	2(a)	1(c)
NEAR COASTAL TRADE					
Ch. Engineer	≥3000	III/2	1	—	—
Ch. Engineer	≥750 but <3000	III/3	—	1	1(b)
2nd Engineer	≥3000	III/2	1	—	—
2nd Engineer	≥750 but <3000	III/3	—	1	—
OOW	≥750	III/1	2(a)	1(a)	1(c)
<p>OOW—Officer in charge of an Engineering Watch—</p> <p>(a) Number of Engineer Officers holding III/1 certification may be reduced by one if the Chief Engineer and 2nd Engineer keep a watch.</p> <p>(b) Other appropriate certification would be considered, such as Boat Engineer Licence Grade 1 or equivalent.</p> <p>(c) Other appropriate certification would be considered, such as Boat Engineer Licence Grade 2 or equivalent.</p>					

Additional Notes—

All Engine Room Watch Ratings are to be qualified in accordance with STCW III/4, except for vessels of <750 kW main engine power, in which case STCW III/4 certification is recommended.

The above levels which are based on manned engine room arrangements, are for guidance only and actual levels will vary according to the type, size, age and trading pattern of the vessel. Manning of vessels having the UMS notation may carry a lower complement of Engineer Officers, but this will be assessed on an individual basis.

UNOFFICIAL VERSION

UPDATED TO 31ST DECEMBER 2016

SEVENTH SCHEDULE

Regulation 33(2).  
[9/2012].



Republic of Trinidad and Tobago

FORM OF DISPENSATION

DISPENSATION ISSUED UNDER THE PROVISIONS OF THE  
SHIPPING ACT, 1987 GIVING EFFECT TO THE  
INTERNATIONAL CONVENTION ON STANDARDS OF  
TRAINING, CERTIFICATION AND WATCHKEEPING FOR  
SEAFARERS, 1978 AS AMENDED IN 1995

(Official Seal)

The Government of the Republic of Trinidad and Tobago certifies that .....  
who is the holder of Certificate No. .... issued by or on behalf of the  
Government of ..... is duly dispensed in accordance with the  
provisions of Article ..... of the above Convention, as amended, and the  
lawful holder is authorised to perform the following functions, at the levels specified,  
subject to any limitations indicated until ..... on board the  
SHIP..... IMO No. ....

FUNCTION	LEVEL	LIMITATIONS APPLYING (IF ANY)

**LAWS OF TRINIDAD AND TOBAGO**

MINISTRY OF THE ATTORNEY GENERAL AND LEGAL AFFAIRS

www.legalaffairs.gov.tt

882

**Chap. 50:10**

*Shipping*

**[Subsidiary]**

*Shipping (Training, Certification, Safe Manning, Hours of Work  
and Watchkeeping) Regulations*

**SEVENTH SCHEDULE**

**FORM OF DISPENSATION—(Continued)**

The lawful holder of this endorsement may serve in the following capacity or capacities specified in the applicable safe manning requirements of the Division:

CAPACITY	LIMITATIONS APPLYING (IF ANY)

Endorsement No. .... Issued on .....

*(Official Seal)*

.....  
*Signature of duly authorised official*

.....  
*Name of duly authorised official*

The original of this dispensation must be kept in accordance with regulation I/2, paragraph 9 of the Convention while serving on a ship.

Date of birth of holder of the certificate .....

Signature of the holder of the certificate .....

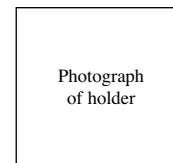

UNOFFICIAL VERSION

UPDATED TO 31ST DECEMBER 2016

**EIGHTH SCHEDULE**

Regulation 51.  
[9/2012].

**SCHEDULE OF FEES**

(Trinidad and Tobago Dollars)

1. An applicant for examination and other services pay the following fees:

Written examination per subject	...	...	\$ 300.00
Oral examinations	...	...	\$ 300.00
A simulator-based examination	...	...	\$ 300.00
Certification	...	...	\$ 300.00
Endorsement or recognition of certificate	...	...	\$ 300.00
Revalidation of certificate	...	...	\$ 300.00
Dispensation	...	...	\$ 300.00
Seaman's record book	...	...	\$ 300.00

Re-sits—

(a) Written per subject	...	...	\$ 400.00
(b) Oral	...	...	\$ 450.00
(c) Simulator-based	...	...	\$ 500.00
(d) Unscheduled examination	...	...	\$ 400.00

2. The fees for an examination shall be forfeited where the applicant fails to appear for the examination at the appointed time.

3. An applicant shall pay the following fees for documents:

Processing application for termination	...	\$ 250.00
Replacement of a certificate, except for a certificate lost owing to shipwreck	...	\$ 500.00
Replacement of an endorsement, except for an endorsement lost owing to shipwreck	...	\$ 400.00
Replacement of a seaman's record book, except for a book lost owing to shipwreck	...	\$ 300.00
Transcript of record of qualifications, seagoing service and/or examinations for a certificate...	...	\$ 200.00

**LAWS OF TRINIDAD AND TOBAGO**

MINISTRY OF THE ATTORNEY GENERAL AND LEGAL AFFAIRS

www.legalaffairs.gov.tt

884

**Chap. 50:10**

*Shipping*

---

**[Subsidiary]**

*Shipping (Training, Certification, Safe Manning, Hours of Work  
and Watchkeeping) Regulations*

Postage and handling (foreign students)	...	\$ 180.00
Certificate cover, replacement	... ..	\$ 150.00
Processing and disuse of a safe manning certificate (to be paid by the company)	... ..	\$ 1000.00

4. Fees shall be paid in cash or by cheque made payable to the Maritime Services Division upon application, and shall not be refundable.

---

UNOFFICIAL VERSION

UPDATED TO 31ST DECEMBER 2016

**SHIPPING (SHIP AND PORT FACILITY SECURITY)  
REGULATIONS**

ARRANGEMENT OF REGULATIONS

REGULATION

**PRELIMINARY**

1. Citation.
2. Interpretation.

**PART I**

**SPECIAL MEASURES TO ENHANCE  
MARITIME SECURITY**

**DIVISION 1**

*General*

3. Application.
4. Responsibilities of Director for security measures.
5. Responsibilities of the designated authority for security measures.
6. Requirements for companies.
7. Ship security plans.
8. Company security officer.
9. Ship security officer.
10. Requirements for ships.
11. Ship security alert system.
12. Threats to ships.
13. Master's discretion for ship safety and security.
14. Verification for ships.
15. Issue, endorsement, duration and validity of certificate.
16. Issue and endorsement of certificates by another Government.
17. Certificates issued or endorsed on behalf of another Government.
18. Interim certification.
19. Prohibition on proceeding to sea without an appropriate certificate.

**DIVISION 2**

*Control and Compliance Measures*

20. Control of ships in port.
21. Ships intending to enter a port.
22. Additional control and compliance provisions.

**LAWS OF TRINIDAD AND TOBAGO**

MINISTRY OF THE ATTORNEY GENERAL AND LEGAL AFFAIRS

www.legalaffairs.gov.tt

886

**Chap. 50:10**

*Shipping*

[Subsidiary]

*Shipping (Ship and Port Facility Security) Regulations*

ARRANGEMENT OF REGULATIONS—*Continued*

**REGULATION**

**DIVISION 3**

*Port Facilities*

23. Responsibilities of the designated authority for port facilities.
24. Duties of port facility operator for port facilities.
25. Port facility security officers.
26. Drills and exercises.

**DIVISION 4**

*Supplementary*

27. Alternative security arrangements.
28. Equivalent security arrangements.
29. Communication of information.

**DIVISION 5**

*Enforcement*

30. Requirement to provide information.
31. Powers of inspection.
32. False statements relating to baggage, cargo, etc.
33. False statements in connection with identity documents.
34. Unauthorised presence in restricted zones.
35. Offences relating to authorised persons.
36. Penalties, defences, etc.

**PART II**

**CONTINUOUS SYNOPSIS RECORD**

37. Continuous Synopsis Record.
38. Transfer of flag by ship.
39. Offences and penalties.
40. Offences and penalty *re* master.

**PART III**

**MISCELLANEOUS**

41. Fees.
42. Offences by bodies corporate.

**SCHEDULE.**

---

UNOFFICIAL VERSION

UPDATED TO 31ST DECEMBER 2016

**SHIPPING (SHIP AND PORT FACILITY SECURITY) REGULATIONS** 131/2004.

*made under section 406(a)*

**PRELIMINARY**

**1.** These Regulations may be cited as the Shipping (Ship and Port Facility Security) Regulations. Citation.

**2.** (1) In these Regulations— Interpretation.

“Act” means the Shipping Act;

“administration” means the Maritime Authority of the State whose flag a ship is entitled to fly;

“authorised person” means a person authorised in writing by or on behalf of the Director or the designated authority for the purposes of these Regulations;

“bulk carrier” means a ship which is generally constructed with single deck, top-side tanks and hopper-side tanks in cargo spaces and intended primarily to carry dry cargo in bulk and includes one carrier and a combination carrier;

“certificate” means an International Ship Security Certificate or an Interim International Ship Security Certificate issued in accordance with Part A of the ISPS Code;

“chemical tanker” means a cargo ship constructed or adapted and used for the carriage in bulk, of any liquid product listed in the Table in Chapter 17 of the IBC Code;

“company” means the owner of a ship or any other organisation or person who has assumed responsibility for the operation of the ship from the owner and has agreed to take over all the duties and responsibilities imposed on a company by the ISPS Code;

“company security officer” means the person designated by the company to ensure that a ship security assessment is carried out, and a ship security plan developed, submitted for approval, implemented and maintained and to liaise with port facility security officers and the ship security officer;

LAWS OF TRINIDAD AND TOBAGO

MINISTRY OF THE ATTORNEY GENERAL AND LEGAL AFFAIRS

www.legalaffairs.gov.tt

888

Chap. 50:10

Shipping

[Subsidiary]

Shipping (Ship and Port Facility Security) Regulations

“Contracting Government” means the government of a State which is party to the Safety Convention;

“Declaration of Security” means an agreement reached between a ship and a port facility or another ship with which it interfaces, specifying the security measures each will implement;

“designated authority” means the organisation or the administration identified as responsible for ensuring the implementation of Chapter XI-2 of the Safety Convention pertaining to port facility security and ship/port interface from the point of view of the port facility and in the case of Trinidad and Tobago, means the Trinidad and Tobago Coast Guard;

“Director” means the Director of Maritime Services referred to in section 403(2)(a) of the Act and includes any person lawfully under the instructions or on behalf of the Director;

“gas carrier” means a cargo ship constructed or adapted for the carriage in bulk, of any liquefied gas or other liquid product identified in Chapter 19 of the IGC Code;

“high speed craft” means a craft capable of a maximum speed in metres per second equal to or exceeding  $307\Delta^{0.1667}$  where—  
 $\Delta$ = displacement corresponding to the design waterline (m<sup>3</sup>);

“IBC Code” means the International Code for the Construction and Equipment of Ships Carrying Dangerous Chemicals in Bulk adopted by the Marine Environment Protection Committee of the IMO by resolution MEPC.19 (22), as amended and adopted by the IMO and brought into force in accordance with the amendment procedures in the International Convention for the Prevention of Pollution from Ships (MARPOL) applicable to an Appendix to an Annex;

“IGC Code” means the International Code for the Construction and Equipment of Ships Carrying Liquefied Gases in Bulk;

“IMO” means the International Maritime Organisation;

“ISM Code” means the International Management Code for the Safe Operation of Ships and of Pollution Prevention adopted by the IMO by Resolution A-741(18);

UNOFFICIAL VERSION

UPDATED TO 31ST DECEMBER 2016

“ISPS Code” or “Code” means the International Code for the Security of Ships and of Port Facilities;

“mobile offshore drilling unit” means a vessel capable of engaging in drilling operations for the exploration for or exploitation of resources beneath the seabed such as liquid or gaseous hydrocarbons, sulphur or salt;

“oil tanker” means a ship constructed or adapted primarily to carry oil in bulk in its cargo spaces and includes—

- (a) a combination carrier;
- (b) a chemical tanker when it is carrying a cargo or part cargo of oil in bulk; and
- (c) a gas carrier when it is carrying a cargo or part cargo of oil in bulk;

“port facility” means a location, as determined by the designated authority, where a ship/port interface takes place and includes anchorages, waiting berths and approaches from seaward, as appropriate;

“port facility operator” means a person operating a port facility;

“port facility security assessment” means an assessment of the security of a port facility carried out in accordance with section 15 of Part A of the Code;

“port facility security officer” means the person designated as responsible for the development, implementation, revision and maintenance of the port facility security plan and for liaison with the ship security officers and company security officers;

“port facility security plan” means a plan developed to ensure the application of measures designed to protect the port facility and ships, persons, cargo, cargo transport units and ships’ stores within the port facility from the risks of a security incident;

“recognised security organisation” means an organisation with appropriate expertise in security matters and appropriate knowledge of ship and port operations, authorised to carry out an assessment, verification, approval or a certification activity, required by these Regulations or by Part A of the ISPS Code;

LAWS OF TRINIDAD AND TOBAGO

MINISTRY OF THE ATTORNEY GENERAL AND LEGAL AFFAIRS

www.legalaffairs.gov.tt

890

**Chap. 50:10**

*Shipping*

[Subsidiary]

*Shipping (Ship and Port Facility Security) Regulations*

“restricted zone” means a zone to which access is restricted for security reasons, pursuant to these Regulations;

“Safety Convention” means the International Convention for the Safety of Life at Sea, 1974 and its Protocol of 1978, together with such amendments thereof or replacements thereof that the Minister may by Order declare to be in effect with respect to Trinidad and Tobago;

“security incident” means any suspicious act or circumstance threatening the security of a ship including a mobile offshore drilling unit and a high speed craft or of a port facility or of any ship/port interface or any ship to ship activity, and which may—

- (a) result in significant loss of life;
- (b) result in environmental change;
- (c) cause disruption in transportation systems; and
- (d) result in the economic disruption of a particular area;

“security level” means the qualification of the degree of risk that a security incident will be attempted or will occur;

“ship/port interface” means the interactions that occur when a ship is directly and immediately affected by actions involving the movement of persons or goods or the provisions of port services to or from the ship;

“ship to ship activity” means any activity not related to a port facility, that involves the transfer of goods or persons from one ship to another;

“tons” means gross tonnage.

(2) In these Regulations, where any reference is made to Part A of the ISPS Code, the guidance provisions in Part B of the Code in relation to that matter shall be taken into account in construing Part A.

(3) For the purposes of these Regulations, references in Part A of the Code to “the Administration” shall be construed as references to “the Director” in relation to Trinidad and Tobago ships.

UNOFFICIAL VERSION

UPDATED TO 31ST DECEMBER 2016

(4) For the purposes of Part I, a person is permitted to have access to a restricted zone of a port facility where he is permitted to enter the zone or where arrangements exist for permitting any of his employees or agents to enter the zone.

**PART I**

**SPECIAL MEASURES TO ENHANCE  
MARITIME SECURITY**

**DIVISION 1**

*General*

- 3.** (1) Subject to subregulation (4), this Part applies to— *Application.*
- (a) the following types of ship engaged on international voyages;
    - (i) passenger ships, including high-speed passenger craft;
    - (ii) cargo ships, including high-speed craft, of five hundred tons or more;
    - (iii) mobile offshore drilling units;
  - (b) port facilities serving such ships engaged on international voyages; and
  - (c) any port facility that is required on occasion to serve ships arriving or departing on international voyages and is specified by way of a notice issued by the designated authority.
- (2) A notice referred to in subregulation (1)(c) shall—
- (a) be issued where a port facility security assessment for the port facility has not been done in accordance with section 15 of Part A of the Code;
  - (b) specify the extent of application of this Part and the relevant sections of Part A of the Code that apply to the facility; and
  - (c) not compromise the level of security intended to be provided by this Part and Part A of the Code.
- (3) Regulations 20, 21 and 22 shall also apply to a port facility not falling within subregulation (1)(b) or (c).

LAWS OF TRINIDAD AND TOBAGO

MINISTRY OF THE ATTORNEY GENERAL AND LEGAL AFFAIRS

www.legalaffairs.gov.tt

892

Chap. 50:10

Shipping

[Subsidiary]

Shipping (Ship and Port Facility Security) Regulations

- (4) This Part does not apply to—
- (a) warships;
  - (b) naval auxiliaries; or
  - (c) other ships owned or operated by Parties to the Safety Convention and used only on Government non-commercial service.

Responsibilities of Director for security measures.

4. (1) Without prejudice to any other duties specified in these Regulations, the Director shall—

- (a) in accordance with section 4 of Part A of the Code, set security levels and ensure the provision of security level information to Trinidad and Tobago ships;
- (b) where changes in security levels occur, update the security level information as the circumstances may require;
- (c) indicate when a Declaration of Security is required for a Trinidad and Tobago ship; and
- (d) be responsible for approving the ship security plan and relevant amendments to a previously approved plan.

(2) The Director may delegate to a recognised security organisation, his responsibilities under this Part except the responsibility to—

- (a) set the applicable security level for ships;
- (b) exercise control and compliance measures pursuant to regulations 20, 21 and 22; and
- (c) establish the requirements for a Declaration of Security.

Responsibilities of the designated authority for security measures.

5. (1) Without prejudice to any other duties under this Part the designated authority shall—

- (a) in accordance with section 4 of Part A of the Code, set security levels and ensure the provision of security level information to port facilities

UNOFFICIAL VERSION

UPDATED TO 31ST DECEMBER 2016

within Trinidad and Tobago and to ships prior to entering a port or whilst in a port within Trinidad and Tobago;

- (b) where changes in security level occur, update security level information as circumstances dictate;
- (c) determine which of the port facilities located within its territory are required to designate a port facility security officer to be responsible for the preparation of the port facility security plan; and
- (d) be responsible for approving the port facility security plan and any subsequent amendments to a previously approved plan.

(2) The designated authority may delegate to a recognised security organisation, its responsibilities under these Regulations, except the responsibility to—

- (a) set applicable security levels for port facilities or ship to ship activity in Trinidad and Tobago territorial waters;
- (b) approve a port facility security assessment and subsequent amendments to an approved assessment;
- (c) determine the port facilities that will be required to designate a port facility security officer;
- (d) approve a port facility security plan and subsequent amendments to an approved plan;
- (e) exercise control and compliance measures pursuant to regulations 20, 21 and 22; and
- (f) establish the requirements for a Declaration of Security.

**6. (1)** A company shall—

- (a) comply with the relevant requirements of this Part and Part A of the Code; and
- (b) ensure that—
  - (i) a company security officer is appointed and properly trained and qualified to perform his duties and responsibilities;

Requirements  
for companies.

- (ii) a ship security officer is appointed for each of its ships and properly trained and qualified to perform his duties and responsibilities;
- (iii) each ship has a ship security plan; and
- (iv) the master has available on board at all times, information through which officers duly authorised by any State can identify—
  - (A) the person responsible for appointing the members of the crew or other persons currently employed or engaged on board the ship in any capacity on the business of the ship;
  - (B) the person responsible for deciding the employment of the ship; and
  - (C) in cases where the ship is employed under the terms of Charter party or parties, the parties to such Charter party or parties.

(2) A company that fails to comply with this Regulation commits an offence.

Ship security plans.

7. (1) A ship security plan or amendments thereto shall be submitted to the Director or to a recognised security organisation authorised to act on his behalf, for approval in accordance with section 9 of Part A of the Code.

(2) A recognised security organisation authorised under subregulation (1) shall not have been involved in the preparation of the ship security plan or the amendment thereto, submitted for approval.

(3) The Director shall determine which changes to an approved ship security plan or to security equipment specified in an approved plan shall not be implemented unless the relevant amendments to the plan are approved by the Director.

(4) A change referred to in subregulation (3) shall be at least as effective as the measures prescribed in this Part and in Part A of the Code.

(5) A company that does not comply with subregulation (1) or otherwise fails to comply with section 9 of Part A of the Code commits an offence.

**8.** (1) A company security officer shall perform the responsibilities and duties of a company security officer specified in this Part and Part A of the Code, in particular those listed in section 11.2 of Part A.

Company security officer.

(2) A company security officer who contravenes this Regulation commits an offence.

**9.** (1) A ship security officer shall perform the responsibilities and duties of a ship security officer specified in this Part and Part A of the Code, in particular those listed in section 12.2 of Part A.

Ship security officer.

(2) A ship security officer who contravenes this Regulation commits an offence.

**10.** (1) A master of a ship shall comply with the relevant requirements of this Part and Part A of the Code.

Requirements for ships.

(2) Prior to entering a port or whilst in a port within the territory of any other State, a master of a ship shall comply with the requirements for the security level set by that State, where such security level is higher than the security level set by the Director for that ship.

(3) A master of a ship shall respond without undue delay to any change to a higher security level.

(4) Where a master of a ship fails to comply with the requirements of this Part or Part A of the Code or cannot comply with the requirements of the security level set by the Director or by another Contracting Government and applicable to that ship, the captain shall notify the appropriate competent authority prior to conducting any ship/port interface or prior to entry into port, whichever occurs earlier.

(5) Where there is a breach of subregulations (1) to (4) in relation to a ship, the company and the master commit an offence.

Ship security alert system.

**11.** (1) The following ships shall be provided with a ship security alert system:

- (a) ships constructed on or after 1st July 2004;
  - (b) passenger ships, including high-speed passenger craft, constructed before 1st July 2004, not later than the first survey of the radio installation after 1st July, 2004;
  - (c) oil tankers, chemical tankers, gas carriers, bulk carriers and cargo high-speed craft, of five hundred tons or more, constructed before 1st July, 2004, not later than the first survey of the radio installation after 1st July, 2004; and
  - (d) other cargo ships of five hundred tons or more and mobile offshore drilling units constructed before 1st July, 2004, not later than the first survey of the radio installation after 1st July, 2004.
- (2) The ship security alert system, when activated, shall—
- (a) initiate and transmit a ship-to-shore security alert to a competent authority designated by the Director, which in these circumstances may include the company, identifying the ship, its location and indicating that the security of the ship is under threat or has been compromised;
  - (b) not send the ship security alert to any other ships;
  - (c) not raise any alarm on board the ship; and
  - (d) continue the ship security alert until deactivated or reset.
- (3) The ship security alert system shall—
- (a) be capable of being activated from the navigation bridge and at least one other location; and
  - (b) conform to performance standards not inferior to those adopted by the IMO.

(4) The ship security alert system activation points shall be so designed as to prevent the inadvertent initiation of the ship security alert.

(5) The requirement for a ship security alert system may be complied with by using the radio installation fitted for compliance with the requirements of Chapter IV of the Safety Convention, provided that there is compliance with this Regulation.

(6) Where the Director receives notification of a ship security alert relating to a Trinidad and Tobago ship, he shall immediately notify the State in the vicinity of which the ship is presently operating.

(7) Where the designated authority receives notification of a ship security alert from a ship that is not a Trinidad and Tobago ship, it shall immediately notify the relevant administration and, if appropriate, the State in the vicinity of which the ship is presently operating.

(8) A contravention of subregulations (1) to (4) shall be an offence by the company.

**12.** (1) The designated authority shall set security levels and ensure the provision of security level information to ships operating in the territorial sea of Trinidad and Tobago or having communicated an intention to enter the territorial sea. Threats to ships.

(2) Where a risk of attack has been identified, the designated authority shall advise the ships concerned and their administrations of—

- (a) the current security level;
- (b) any security measures that should be put in place by the ships concerned to protect themselves from attack, in accordance with Part A of the Code; and
- (c) security measures that the designated authority puts in place, as appropriate.

**13.** (1) The master of a Trinidad and Tobago ship shall not be constrained by the company, the charterer or any other person Master's discretion for ship safety and security.

LAWS OF TRINIDAD AND TOBAGO

MINISTRY OF THE ATTORNEY GENERAL AND LEGAL AFFAIRS

www.legalaffairs.gov.tt

898

Chap. 50:10

Shipping

[Subsidiary]

Shipping (Ship and Port Facility Security) Regulations

from taking or executing any decision which, in the professional judgement of the master, is necessary to maintain the safety and security of the ship.

(2) The decisions at subregulation (1) shall include the denial of access to persons, except those identified as duly authorised by Contracting Governments, or their effects and refusal to load cargo, including containers or other closed cargo transport units.

(3) Where, in the professional judgement of the master, a conflict between any safety and security requirements applicable to the ship arises during its operations, the master shall give effect to those requirements necessary to maintain the safety of the ship.

(4) In cases referred to in subregulation (3), the master may implement temporary security measures and shall forthwith inform the Director and, where appropriate, the contracting government in whose port the ship is operating or intends to enter.

(5) Any temporary security measures referred to in subregulation (4) shall, to the highest possible degree, be commensurate with the prevailing security level.

(6) Where cases referred to in subregulation (3) are identified, the director shall ensure that such conflicts are resolved and that the possibility of recurrence is minimised.

Verification for ships.

**14.** (1) All Trinidad and Tobago ships to which this Part applies shall be subject to initial, renewal and intermediate verifications in accordance with section 19.1.1 of Part A of the Code.

(2) The verification of ships shall be carried out by an officer duly authorised by the Director or by a recognised security organisation authorised to act on his behalf.

(3) The security system and any associated security equipment of the ship after verification shall be maintained to conform with regulations 7 and 11, Part A of the ISPS Code and the approved ship security plan.

UNOFFICIAL VERSION

UPDATED TO 31ST DECEMBER 2016

(4) After any verification under subregulation (1), no changes shall be made in the security system and in any associated security equipment or the approved ship security plan without the sanction of the Director.

(5) Any contravention of subregulation (1) or (3) shall be an offence by both the company and master.

**15.** (1) When an initial or renewal verification is satisfactorily completed pursuant to regulation 14, the Director or a recognised security organisation acting on his behalf shall issue or, as the case may be, endorse an International Ship Security Certificate.

Issue, endorsement, duration and validity of certificate.

(2) The International Ship Security Certificate shall be drawn up in a form corresponding to the model given in the Appendix to Part A of the Code.

(3) The duration and validity of an International Ship Security Certificate shall be in accordance with section 19.3 of Part A of the Code.

**16.** (1) The Director may request another Contracting Government to verify the ship and, if satisfied that there has been compliance with section 19.1.1 of the Code, to issue or authorise the issue of an International Ship Security Certificate to the ship and, where appropriate, endorse or authorise the endorsement of that Certificate on the ship, in accordance with the Code.

Issue and endorsement of certificates by another Government.

(2) A Certificate so issued or endorsed shall contain a statement to the effect that it has been issued or endorsed at the request of the Director and have the same effect as if issued or endorsed by the Director.

**17.** (1) The Director may, at the request of another Contracting Government, verify the ship and, if satisfied that there has been compliance with section 19.1.1 of the Code, issue or authorise the issue of an International Ship Security Certificate to the ship and, where appropriate, endorse or authorise the endorsement of that Certificate on the ship, in accordance with the Code.

Certificates issued or endorsed on behalf of another Government.

LAWS OF TRINIDAD AND TOBAGO

MINISTRY OF THE ATTORNEY GENERAL AND LEGAL AFFAIRS

www.legalaffairs.gov.tt

900

Chap. 50:10

Shipping

[Subsidiary]

Shipping (Ship and Port Facility Security) Regulations

(2) A Certificate so issued or endorsed shall contain a statement to the effect that it has been issued or endorsed at the request of that Government and have the same effect as if the Certificate had been issued or endorsed by that Government.

Interim  
certification.

18. (1) After 1st July, 2004, for the purposes of—

- (a) a ship without a Certificate, on delivery or prior to its entry or re-entry into service;
- (b) transfer of a ship from the flag of another Government to the Trinidad and Tobago register; or
- (c) a company assuming the responsibility for the operation of a ship not previously operated by that company,

until the Certificate referred to in regulation 15(1), 16(1) or 17(1) is issued, the Director may cause an Interim International Ship Security Certificate to be issued, in a form corresponding to the model given in the Appendix to Part A of the Code.

(2) An Interim International Ship Security Certificate shall only be issued if the Director or a recognised security organisation acting on his behalf is satisfied that the conditions specified in sections 19.4.2.1 to 19.4.2.7 of Part A of the Code are met.

(3) An Interim International Ship Security Certificate may be issued by the Director or a recognised security organisation authorised to act on his behalf.

(4) An Interim International Ship Security Certificate shall be valid for six months, or until the Certificate required by regulation 15(1), 16(1) or 17(1) is issued, whichever comes first, and may not be extended.

(5) A subsequent, consecutive Interim International Ship Security Certificate shall not be issued to a ship where, in the judgement of the Director or the recognised security organisation,

UNOFFICIAL VERSION

UPDATED TO 31ST DECEMBER 2016

one of the purposes of the ship or a company in requesting such certificate is to avoid full compliance with this Part beyond the period of the initial Interim Certificate as specified in subregulation (1).

(6) For the purposes of regulations 20, 21 and 22 the Director may, prior to accepting an Interim International Ship Security Certificate as a valid Certificate, ensure that the requirements of sections 19.4.2.4 to 19.4.2.6 of Part A of the Code have been met.

**19.** (1) A Trinidad and Tobago ship that is required to be verified under this part shall not proceed, or attempt to proceed to sea, unless there is in force a valid International Ship Security Certificate or Interim International Ship Security Certificate.

Prohibition on proceeding to sea without an appropriate certificate.

(2) Where a Trinidad and Tobago ship proceeds or attempts to proceed to sea in contravention of subregulation (1), the company and the master commit an offence.

## DIVISION 2

### *Control and Compliance Measures*

**20.** (1) For the purpose of these Regulations, a ship to which this Part applies is subject to control by officers duly authorised by the Director when in a port in Trinidad and Tobago.

Control of ships in port.

(2) The control referred to in subregulation (1) shall be limited to verifying that there is on board a valid Certificate, which, shall be accepted, unless there are clear grounds for believing that the ship is not in compliance with the requirements of these Regulations or Part A of the Code.

(3) When there are such clear grounds, or where no valid Certificate is produced when required, the duly authorised officers shall impose any one or more of the control measures in relation to that ship as provided in subregulation (5).

(4) The control measures imposed must be proportionate, taking into account the guidance given in Part B of the Code.

LAWS OF TRINIDAD AND TOBAGO

MINISTRY OF THE ATTORNEY GENERAL AND LEGAL AFFAIRS

www.legalaffairs.gov.tt

902

Chap. 50:10

Shipping

[Subsidiary]

Shipping (Ship and Port Facility Security) Regulations

(5) The control measures are as follows:

- (a) inspection of the ship;
- (b) delaying the ship;
- (c) detention of the ship;
- (d) restriction of operations including movement within the port; or
- (e) expulsion of the ship from port.

(6) The control measures referred to in subregulation (5) may additionally or alternatively include other lesser administrative or corrective measures.

Ships intending to enter a port.

**21.** (1) The Director shall require a company or the master of a ship intending to enter the ship in a port in Trinidad and Tobago to provide the following information in order to ensure compliance with this Part prior to entry into the port with the aim of avoiding the need to impose control measures or steps:

- (a) that there is in respect of the ship, a valid Certificate and the name of its issuing authority;
- (b) the security level at which the ship is currently operating;
- (c) the security level at which the ship operated in any previous port where it has conducted a ship/port interface within the parameters specified in subregulation (4);
- (d) any special or additional security measures that were taken by the ship in any previous port where it has conducted a ship/port interface within the parameters specified in subregulation (4);
- (e) that the appropriate ship security procedures were maintained during any ship to ship activity within the parameters specified in subregulation (4); or
- (f) other practical security related information, but not details of the ship security plan, taking into account the guidance given in Part B of the Code,

and the master of the ship or the company shall provide additional confirmation of the above information upon the request of the Director.

UNOFFICIAL VERSION

UPDATED TO 31ST DECEMBER 2016

(2) A Trinidad and Tobago ship to which this Part applies, intending to enter the port of another Contracting Government, shall provide the information specified in subregulation (1) on the request of the officers duly authorised by that Government.

(3) The master of a ship referred to in subregulation (2) may decline to provide such information on the understanding that failure to do so may result in denial of entry into port.

(4) The ship shall keep records of the information referred to in subregulation (2) for the last ten calls at port facilities.

(5) Where, after receipt of the information described in subregulation (1), the Director has clear grounds for believing that the ship is not in compliance with the requirements of this Part and Part A of the Code, he shall attempt to establish communication with and between the ship and its administration in order to rectify the non-compliance.

(6) Where the communication referred to in subregulation (5) does not result in rectification or the Director has clear grounds otherwise for believing that the ship is not in compliance with the requirements of this Part and Part A of the Code, he may take the steps specified in subregulation (8) in relation to the ship.

(7) The steps specified in subregulation (8) shall be proportionate, taking into account the guidance given in Part B of the ISPS Code.

(8) The steps referred to in subregulation (6) are as follows:

- (a) a requirement for the rectification of the non-compliance;
- (b) a requirement that the ship proceed to a location specified in the territorial sea or internal waters of Trinidad and Tobago;
- (c) inspection of the ship, where the ship is in the territorial sea of Trinidad and Tobago; or
- (d) denial of entry into port.

(9) Prior to initiating any steps specified in subregulation (8), the Director shall inform the master of the ship or the company of his intentions.

(10) Upon receipt of information referred to in subregulation (9), the master of the ship may withdraw the intention to enter the port, in which case subregulation (8) shall not apply.

Additional control and compliance provisions.

**22.** (1) Where—

- (a) a control measure referred to in regulation 20 is imposed; or
- (b) any of the steps referred to in regulation 21(8) are taken,

the Director shall forthwith inform the administration in writing, specifying the control measures imposed or steps taken and the reasons thereof.

(2) The Director shall also notify the recognised security organisation that issued the Certificate relating to the ship concerned and the IMO when any such control measures have been imposed or steps taken.

(3) Where entry into port is denied or a ship is expelled from a port in Trinidad and Tobago, the Director shall communicate the appropriate facts to the relevant authorities of the State of the next port of call, where known, and any other appropriate coastal States, taking into account any guidelines developed by the IMO.

(4) Confidentiality and security of notification referred to in subregulation (3) shall be ensured.

(5) An officer duly authorised by the Director shall deny a ship entry into port, pursuant to regulation 21(8)(d), or expel it from port, pursuant to regulation 20, only where he has clear grounds to believe that the ship poses an immediate threat to the security or safety of persons or of ships or other property and there are no other appropriate means for removing the threat.

(6) The control measures referred to in regulation 20(5) and the referred to in regulation 21(8) shall only be imposed, pursuant to regulations 20 and 21, until the non-compliance giving rise to the control measures or steps, has been corrected to the satisfaction of the Director.

(7) When control is exercised under regulation 20 or steps taken under regulation 21—

- (a) all possible efforts shall be made to avoid a ship being unduly detained or delayed; and
- (b) necessary access to the ship for emergency or humanitarian reasons or security purposes, shall not be prevented.

(8) Where a ship is thereby unduly detained, or delayed, it shall be entitled to compensation for loss or damage suffered as a result.

**DIVISION 3**

*Port Facilities*

**23.** (1) The designated authority shall ensure that—

- (a) port facility security assessments are carried out, reviewed and approved in accordance with Part A of the Code; and
- (b) port facility security plans are developed, reviewed, approved and implemented in accordance with Part A of the Code.

Responsibilities of the designated authority for port facilities.

(2) The designated authority shall communicate to the port facility operator and the port facility security officer, the measures required to be addressed in a port facility security plan for the various security levels, including when the submission of a Declaration of Security will be required.

**24.** (1) The port facility operator shall—

- (a) ensure that port facilities comply with the relevant requirements of this Part and Part A of the Code;
- (b) appoint a suitably qualified port facility security officer, and ensure that he receives appropriate training, as specified in section 18.1 of Part A of the Code;
- (c) provide the port facility security officer with the resources, assistance and support necessary to enable him to carry out his duties;

Duties of port facility operator for port facilities.

LAWS OF TRINIDAD AND TOBAGO

MINISTRY OF THE ATTORNEY GENERAL AND LEGAL AFFAIRS

www.legalaffairs.gov.tt

906

Chap. 50:10

Shipping

[Subsidiary]

Shipping (Ship and Port Facility Security) Regulations

- (d) ensure that port facility personnel having specific security duties have appropriate knowledge and receive appropriate training as specified in section 18.2 of Part A of the Code; and
- (e) ensure that other port facility personnel have appropriate knowledge as specified in section 18.3 of Part A of the Code.

(2) A port facility operator who fails to comply with this Regulation without reasonable excuse commits an offence.

Port facility security officers.

**25.** (1) A port facility security officer shall carry out the duties and responsibilities placed on him by this Part and Part A of the Code, in particular those listed in section 17.2 of Part A of the Code.

(2) A port facility security officer who fails to comply with this Regulation without reasonable excuse commits an offence.

Drills and exercises.

**26.** (1) To ensure the effective implementation of the port facility security plan, drills shall be carried out at appropriate intervals, taking into account the types of operation of the port facility, changes in port facility personnel, the types of ship the port facility is serving, other relevant circumstances and the guidance given in Part B of the Code.

(2) The port facility security officer shall ensure the effective co-ordination and implementation of the port facility security plan by participating in exercises at appropriate intervals, taking into account the guidance given in Part B of the Code.

(3) A port facility security officer who contravenes subregulation (1) without reasonable excuse commits an offence.

DIVISION 4

Supplementary

Alternative security arrangements.

**27.** (1) The designated authority may, when implementing this Part and Part A of the Code, conclude in writing bilateral or multilateral agreements with other Contracting Governments on alternative security arrangements covering short international voyages on fixed routes between port facilities located within their respective territories.

UNOFFICIAL VERSION

UPDATED TO 31ST DECEMBER 2016

- (2) An agreement referred to in subregulation (1) shall—
- (a) not compromise the level of security of other ships or port facilities not covered by the agreement; and
  - (b) be reviewed periodically, taking into account the experience gained as well as any changes in the particular circumstances or the assessed threats to the security of the ships, the port facilities or the routes covered by the agreement.

(3) A ship covered by such an agreement shall not conduct any ship to ship activities with a ship not covered by the agreement.

**28.** (1) The Director may allow a particular ship or a group of Trinidad and Tobago ships to implement other security measures equivalent to those prescribed in this Part or in Part A of the Code, where such security measures are at least as effective as those prescribed in this Part or Part A of the Code.

Equivalent security arrangements.

(2) Where the Director allows such security measures referred to in subregulation (1), he shall communicate to the IMO, the particulars thereof.

(3) When implementing this Part and Part A of the Code, the designated authority may allow a particular port facility or a group of port facilities located within its territory, other than those covered by an agreement concluded under regulation 27, to implement security measures equivalent to those prescribed in this Part or in Part A of the Code, where such security measures are at least as effective as those prescribed in this Part or Part A of the Code.

(4) Where the designated authority allows such security measures, it shall communicate to the IMO, the particulars thereof.

**29.** (1) The Director shall, no later than 1st July, 2004, communicate to the IMO and make available for the information of companies and ships—

Communication of information.

- (a) the names and contact details of their national authority or authorities responsible for ship and port facility security;
- (b) the locations within their territory covered by the approved port facility security plans;

- (c) the names and contact details of those who have been designated to be available at all times to receive and act upon the ship-to-shore security alerts, referred to in regulation 11(2)(a);
- (d) the names and contact details of those who have been designated to be available at all times to receive and act upon any communications from Contracting Governments exercising control and compliance measures in accordance with regulation 9.3.1 of Chapter XI-2 of the Safety Convention; and
- (e) the names and contact details of those who have been designated to be available at all times to provide advice or assistance to ships and to whom ships can report any security concerns, referred to in regulation 7.2 of Chapter XI-2 of the Safety Convention,

and thereafter update such information as and when changes relating thereto occur.

(2) The Director shall, not later than 1st July, 2004, communicate to the IMO, the names and contact details of any recognised security organisations authorised to act on his behalf together with details of the specific responsibility and conditions of authority delegated to such organisations.

(3) The information referred to in subregulation (2) shall be updated as and when changes relating thereto occur.

(4) The designated authority shall, not later than 1st July, 2004, communicate to the IMO, a list showing the approved port facility security plans for the port facilities located within its territory together with the location covered by each approved port facility security plan and the corresponding date of approval and thereafter shall further communicate when any of the following changes takes place or are contemplated:

- (a) changes in the location covered by an approved port facility security plan are to be introduced or have been introduced and in such cases the information to be communicated shall indicate

the changes in the location covered by the plan and the date as of which such changes are to be introduced or were implemented;

- (b) an approved port facility security plan, previously included in the list submitted to the IMO, is to be withdrawn or has been withdrawn and in such cases, the information to be communicated shall indicate the date on which the withdrawal will take effect or was implemented whereupon in these cases, the communication shall be made to the IMO as soon as is practically possible; and
- (c) additions are to be made to the list of approved port facility security plans.

(5) The information to be communicated under subregulation (4) shall indicate the location covered by the plan and the date of approval.

(6) The Director shall, at five-year intervals after 1st July, 2004, communicate to the IMO a revised and updated list showing all the approved port facility security plans for all port facilities together with the location covered by each approved port facility security plan, and the corresponding date of approval and the date of approval of any amendments thereto which will supersede and replace all information communicated to the IMO, pursuant to subregulation (4), during the preceding five years.

(7) The designated authority shall communicate to the IMO, information that an agreement under regulation 27 has been entered into, amended or terminated.

(8) The information communicated in accordance with subregulation (7) shall include—

- (a) the names of the governments which have concluded the agreement;
- (b) the port facilities and the fixed routes covered by the agreement;
- (c) the periodicity of review of the agreement;
- (d) the date of entry into force of the agreement; and
- (e) information on any consultations which have taken place with other Governments.

LAWS OF TRINIDAD AND TOBAGO

MINISTRY OF THE ATTORNEY GENERAL AND LEGAL AFFAIRS

www.legalaffairs.gov.tt

910

Chap. 50:10

Shipping

[Subsidiary]

Shipping (Ship and Port Facility Security) Regulations

(9) Where the Director allows, under regulation 28, any equivalent security arrangements with respect to a ship entitled to fly its flag or with respect to a port facility located within its territory, he shall communicate to the IMO, the particulars thereof.

DIVISION 5

Enforcement

Requirement to provide information.

**30.** (1) Notwithstanding regulation 21, but subject to sections 9.8 and 9.9 of Part A of the Code, the designated authority may, by notice in writing served on any of the following persons:

- (a) the owner, charterer, manager or master of any ship which is in, or appears to the designated authority to be likely to enter, a port facility;
- (b) a port facility operator;
- (c) a person who carries on operations in a port facility; and
- (d) a person who is permitted to have access to a restricted zone of a port facility for the purposes of the activities of a business carried on by him,

require that person to provide the designated authority with such information specified in the notice as the authority may require in connection with the exercise of its functions under this Part.

(2) A notice under subregulation (1) shall specify a date before which the information required by the notice is to be furnished to the designated authority.

(3) Any such notice may also require the person on whom it is served, after he has furnished to the designated authority the information required by the notice, to inform the authority if at any time the information previously furnished, including any information furnished in pursuance of a requirement imposed by virtue of this subregulation, is rendered inaccurate by any change of circumstances, including the taking of any further measures for purposes of this Part or the alteration of discontinuance of any measures already being taken.

UNOFFICIAL VERSION

UPDATED TO 31ST DECEMBER 2016

(4) Insofar as such a notice requires further information to be furnished to the designated authority in accordance with subregulation (3), it shall require that information to be furnished to it before the end of such period as is specified in the notice for the purposes of this subregulation.

(5) A notice served on a person under subregulation (1) may at any time—

- (a) be revoked by a notice in writing served on him by the designated authority; or
- (b) be varied by a further notice under subregulation (1).

(6) The Director may, in the manner specified in subregulations (1) to (5), require the owner, charterer, manager or master of a Trinidad and Tobago ship to provide him with information, and subregulations (1) to (5) shall apply as if references to the designated authority were references to the Director.

(7) A person who—

- (a) without reasonable excuse, fails to comply with a requirement imposed on him by a notice under this Regulation; or
- (b) in furnishing any information so required, makes a statement which he knows to be false in a material particular, or recklessly makes a statement which is false in a material particular,

commits an offence.

**31.** (1) An authorised person may, on production, where required, of his credentials, inspect— Powers of inspection.

- (a) a Trinidad and Tobago ship;
- (b) another ship while in a port facility;
- (c) a port facility; or
- (d) land outside a port facility which is occupied for the purposes of a business by a person who—
  - (i) carries on, or appears to the authorised person to be about to carry on, harbour operations in a port facility for the purposes of the business; or

LAWS OF TRINIDAD AND TOBAGO

MINISTRY OF THE ATTORNEY GENERAL AND LEGAL AFFAIRS

www.legalaffairs.gov.tt

912

Chap. 50:10

Shipping

[Subsidiary]

Shipping (Ship and Port Facility Security) Regulations

- (ii) is permitted or appears to the authorised person to be about to be permitted, to have access to a restricted zone of a port facility for the purposes of the activities of that business.

(2) An authorised person inspecting a ship, a port facility or land outside a port facility under subregulation (1) may—

- (a) subject the property found by him on the ship, or the land outside the port facility, to such tests;
- (b) take such steps—
  - (i) to ascertain what practices or procedures are being followed in relation to security; or
  - (ii) to test the effectiveness of any practice or procedure relating to security; or
- (c) require the owner, charterer, manager or master of the ship, the port facility operator or the occupier of the land to furnish to him, such information,

as the authorised person may consider necessary for the purpose for which the inspection is carried out.

(3) Subject to subregulation (4), an authorised person, for the purpose of exercising any power conferred on him by subregulation (1) or (2) in relation to a ship, a port facility or land outside a port facility, may—

- (a) go on board a ship and to take all such steps as are necessary to ensure that it is not moved;
- (b) enter any building or works in the port facility or enter upon any land in the port facility; or
- (c) enter upon the land outside a port facility and to enter any building or works on the land.

(4) An authorised person shall not use force for the purpose of going on board a ship, entering any building or works or entering upon any land.

(5) A person who—

- (a) without reasonable excuse, fails to comply with a requirement imposed on him under subregulation (2)(c); or

UNOFFICIAL VERSION

UPDATED TO 31ST DECEMBER 2016

(b) in furnishing any information so required, makes a statement which he knows to be false in a material particular, or recklessly makes a statement which is false in a material particular, commits and offence.

**32.** (1) A person commits an offence where in answer to a question which—

False statements relating to baggage, cargo, etc.

- (a) relates to any baggage, cargo or stores, whether belonging to him or to another, that is or are intended for carriage by sea—
  - (i) by a Trinidad and Tobago ship; or
  - (ii) by another ship to or from a Trinidad and Tobago ship; and
- (b) is put to him for purposes of this Part by—
  - (i) a port facility operator;
  - (ii) the owner, charterer or manager of a ship; and
  - (iii) a person who—
    - (A) is permitted to have access to a restricted zone of a port facility for the purposes of the activities of a business carried on by him; and
    - (B) has control in that restricted zone over the baggage, cargo or stores to which the question relates;
  - (iv) by an employee or agent of such a person referred to in subparagraphs (i) to (iii) in his capacity as employee or agent; or
  - (v) by a police officer,

he makes a statement which he knows to be false in a material particular, or recklessly makes a statement which is false in a material particular.

(2) In subregulation (1)—

- (a) “cargo” includes mail;
- (b) “ship” does not include a ship used in naval, customs or police service; and

LAWS OF TRINIDAD AND TOBAGO

MINISTRY OF THE ATTORNEY GENERAL AND LEGAL AFFAIRS

www.legalaffairs.gov.tt

914

Chap. 50:10

Shipping

[Subsidiary]

Shipping (Ship and Port Facility Security) Regulations

- (c) “stores” means any goods intended for sale or use in a ship, including fuel and spare parts and other articles of equipment, whether or not for immediate fitting.

False statements in connection with identity documents.

**33.** (1) A person commits an offence where—

- (a) for the purpose of, or in connection with, an application made by him or another for the issue of an identity document to which this subregulation applies; or
- (b) in connection with the continued holding by him or another, of any such document which has already been issued,

he makes to a person specified in subregulation (3), an employee or agent of such a person or a police officer, a statement which he knows to be false in a material particular, or recklessly makes to the person, employee or agent or police officer, a statement which is false in a material particular.

(2) Subregulation (1) applies to any identity document which is to be or has been issued by any of the persons specified in subregulation (3) for the purposes of a ship security plan or a port facility security plan.

(3) The persons referred to in subregulation (1) are—

- (a) a port facility operator;
- (b) the owner, charterer or manager of any ship; or
- (c) any person who is permitted to have access to a restricted zone of a port facility for the purposes of the activities of a business carried on by him.

Unauthorised presence in restricted zones.

**34.** (1) A person shall not—

- (a) go, with or without a vehicle or vessel, onto or into any part of a restricted zone of a port facility except with the permission of the port facility security officer or a person acting on behalf of the port facility security officer and in accordance with any conditions subject to which that permission is for the time being granted; or

UNOFFICIAL VERSION

UPDATED TO 31ST DECEMBER 2016

(b) remain in any part of such a restricted zone after being requested to leave by the port facility security officer or a person acting on behalf of the port facility security officer.

(2) Subject to subregulation (3), a person who contravenes subregulation (1) commits an offence.

(3) A person does not commit an offence under subregulation (1)(a) unless it is proved that, at the material time, notices stating that the area concerned was a restricted zone were posted so as to be readily seen and read by persons entering the restricted zone.

**35.** A person who—

- (a) intentionally obstructs an authorised person acting in the exercise of a power conferred on him by or under these Regulations; or
- (b) falsely pretends to be an authorised person,

commits an offence.

Offences relating to authorised persons.

**36.** (1) A person who commits an offence under this Part is liable upon summary conviction to a fine of three hundred thousand dollars and to imprisonment for two years.

Penalties, defences, etc.

(2) It shall be a defence for a person charged under subregulation (1) to show that he took all reasonable precautions and exercised all due diligence to avoid the commission of the offence.

(3) Where an offence under this Regulation is committed, or would have been committed save for the operation of subregulation (2), by any person due to the act or default of some other person, that other person commits the offence, and a person may be charged with and convicted of an offence by virtue of this subregulation whether or not proceedings are taken against the first mentioned person.

## PART II

## CONTINUOUS SYNOPSIS RECORD

Continuous  
Synopsis  
Record.

37. (1) This Regulation applies to all ships engaged on international voyages, except—

- (a) ships of war and troop ships;
- (b) cargo ships of less than five hundred tons;
- (c) ships not propelled by mechanical means;
- (d) wooden ships of primitive build;
- (e) pleasure vessels not engaged in trade; and
- (f) fishing vessels.

(2) All ships shall be provided with a Continuous Synopsis Record for the purpose of providing an on board record of the history of the ship with respect to the information recorded therein.

(3) For ships constructed before 1st July, 2004, the Continuous Synopsis Record shall provide the history of the ship as from 1st July, 2004.

(4) The Continuous Synopsis Record shall be issued by the Director to each Trinidad and Tobago ship and contain the following information:

- (a) the name of the State whose flag the ship is entitled to fly;
- (b) the date on which the ship was registered in Trinidad and Tobago;
- (c) the ship's identification number in accordance with the Shipping (Registration) Regulations;
- (d) the name of the ship;
- (e) the port at which the ship is registered;
- (f) the name of the registered owner and his registered address;
- (g) the name of the registered bareboat charterer and his registered address, where applicable;
- (h) the name of the company, its registered address and the address from where it carries out the safety management activities;
- (i) the name of the classification society with which the ship is classed;

Sub. Leg.

- (j) the name of the Director or of the Contracting Government or of the recognised organisation which has issued the Document of Compliance, or the Interim Document of Compliance specified in the ISM Code, to the company operating the ship and the name of the body which has carried out the audit on the basis of which the document was issued, if other than that issuing the document;
  - (k) the name of the Director or of the Contracting Government or of the recognised organisation that has issued the Safety Management Certificate or the Interim Safety Management Certificate, specified in the ISM Code, to the ship and the name of the body which has carried out the audit on the basis of which the certificate was issued, if other than that issuing the certificate;
  - (l) the name of the Director of the Contracting Government or of the recognised security organisation that has issued the International Ship Security Certificate (or an Interim International Ship Security Certificate), specified in part A of the Code, to the ship and the name of the body which has carried out the verification on the basis of which the certificate was issued, if other than that issuing the certificate; and
  - (m) the date on which the ship ceased to be registered in Trinidad and Tobago.
- (5) The Continuous Synopsis Record shall be kept on board the ship and be available for inspection at all times.
- (6) Any changes relating to the entries referred to in subregulation (4)(d) to (m) shall be recorded in the Continuous Synopsis Record so as to provide updated and current information together with the history of the changes.
- (7) In case of any changes relating to the entries referred to in subregulation (4)(a), the Director shall issue, as soon as is practicable but not later than three months from the date of the

LAWS OF TRINIDAD AND TOBAGO

MINISTRY OF THE ATTORNEY GENERAL AND LEGAL AFFAIRS

www.legalaffairs.gov.tt

918

Chap. 50:10

Shipping

[Subsidiary]

Shipping (Ship and Port Facility Security) Regulations

change, to the ships entitled to fly the Trinidad and Tobago flag either a revised and updated version of the Continuous Synopsis Record or appropriate amendments thereto.

(8) In case of any changes relating to the entries referred to in subregulation (4) the Director, pending the issue of a revised and updated version of the Continuous Synopsis Record, shall authorise and require either the company or the master of the ship to amend the Continuous Synopsis Record to reflect the changes.

(9) Where the Continuous Synopsis Record has been amended the Company shall, without delay, inform the Director accordingly.

(10) The Continuous Synopsis Record shall be in the format developed by the IMO and shall be maintained in accordance with guidelines developed by the IMO.

(11) Any previous entries in the Continuous Synopsis Record shall not be modified, deleted or, in any way, erased or defaced.

Transfer of flag  
by ship.

**38.** (1) Where a ship is transferred to the flag of another State, or sold to another owner, or is taken over by another bareboat charterer, or another company assumes the responsibility for the operation of the ship, the Continuous Synopsis Record shall be left on board.

(2) When a ship is to be transferred to the flag of another State, the company shall notify the Director of the name of the State under whose flag the ship is to be transferred so as to enable the Director to forward to that State a copy of the Continuous Synopsis Record covering the period during which the ship was under his jurisdiction.

(3) When a ship is transferred to the flag of another State the Government of which is a Contracting Government, the Director shall transmit to the administration as soon as possible after the transfer takes place a copy of the relevant Continuous Synopsis Record covering the period during which the ship was under Trinidad and Tobago jurisdiction together with any Continuous Synopsis Records previously issued to the ship by other States.

UNOFFICIAL VERSION

UPDATED TO 31ST DECEMBER 2016

(4) When a ship is transferred to the flag of another State, the Director shall append the previous Continuous Synopsis Records to the current Continuous Synopsis Record issued in respect of the ship so as to provide the continuous history record intended by this Regulation.

**39.** Where the company fails—

Offences and penalties.

- (a) to provide to the Director the information required by regulation 37(4) where requested by the Director;
- (b) to inform the Director of the changes referred to in regulation 37(6);
- (c) to make the changes in the Continuous Synopsis Record as he is required to make under regulation 37(7);
- (d) to inform the Director as is required by regulation 37(9); or
- (e) to ensure the Continuous Synopsis Record is left on the ship and is available for inspection as required by regulation 37(5),

the company commits an offence and is liable on summary conviction to a fine of three hundred thousand dollars.

**40.** A master who fails to—

Offences and penalties *re* master.

- (a) make any changes in the Continuous Synopsis Record that he is required to make under regulation 37(6); or
- (b) ensure the Continuous Synopsis Record is left on the ship and is available for inspection as required by regulation 37(5),

commits an offence and is liable on summary conviction to a fine of one hundred and fifty thousand dollars.

LAWS OF TRINIDAD AND TOBAGO

MINISTRY OF THE ATTORNEY GENERAL AND LEGAL AFFAIRS

www.legalaffairs.gov.tt

920

Chap. 50:10

Shipping

[Subsidiary]

Shipping (Ship and Port Facility Security) Regulations

PART III

MISCELLANEOUS

Fees.  
Schedule.

41. A recipient of a service specified in the first column of the Schedule shall pay the fee specified in the second column for the service.

Offences by  
bodies  
corporate.

42. Where an offence under these Regulations committed by a body corporate is proved to have been committed with the consent or connivance of, or to be attributable to any neglect on the part of, any director, manager, secretary or other similar officer of the body corporate or any person who was purporting to act in any such capacity, he, as well as the body corporate, commits an offence and is liable to be proceeded against and punished accordingly.

Regulation 41.

SCHEDULE

<i>Service</i>	<i>Fees</i>
For the issue of:	
International Ship Security Certificate ... ..	\$1,500.00
Interim International Ship Security Certificate ... ..	\$1,000.00
Statement of Compliance of a Port Facility ... ..	\$1,500.00
Endorsement of Certificate ... ..	\$1,000.00

**SHIPPING (SMALL COMMERCIAL VESSELS)  
REGULATIONS**

ARRANGEMENT OF REGULATIONS

REGULATION

**PART I**

**GENERAL**

1. Citation.
2. Interpretation.
3. Application.
4. Exemptions.
5. Equivalent standards.

**PART II**

**REQUIREMENTS FOR VESSELS**

6. Vessels to be surveyed within one year.
7. Application for Certificate.
8. Survey or inspection.
9. Application for renewal of Certificate.
10. Interval for surveyor inspection for renewal of certificate.
11. Loss of Certificate.
12. Suspension or cancellation of certificate of inspection.
13. Responsibilities of owner and master.
14. Prohibition on proceeding to sea.

**PART III**

**BOATMASTERS AND BOAT ENGINEERS**

15. Boatmaster and Boat Engineer.
16. Issue of licence.
17. Grade and area restrictions of Boatmaster licence.
18. Grade and area restrictions of Boat Engineer licence.
19. Renewal of licence.
20. Intervals for renewal of licences.
21. Record to be kept.

**LAWS OF TRINIDAD AND TOBAGO**

MINISTRY OF THE ATTORNEY GENERAL AND LEGAL AFFAIRS

www.legalaffairs.gov.tt

922

**Chap. 50:10**

*Shipping*

[Subsidiary]

*Shipping (Small Commercial Vessels) Regulations*

---

ARRANGEMENT OF REGULATIONS—*Continued*

**REGULATION**

- 22. Loss of licence.
- 23. Suspension or cancellation of licence.

**PART IV**

**HOURS OF WORK**

- 24. Duty of owner, master, seamen.
- 25. Hours of rest on voyages which exceed 24 hours.
- 26. Working hours of a master on voyages of less than 24 hours.
- 27. Contravention of regulation 26.

**PART V**

**MANNING AND TRAINING**

- 28. Manning.
- 29. Training in emergency procedures.

**PART VI**

**MISCELLANEOUS**

- 30. Penalties.
- 31. Power to detain.
- 32. Prescribed fees.

**FIRST SCHEDULE.**

**SECOND SCHEDULE.**

**THIRD SCHEDULE.**

**FOURTH SCHEDULE.**

**FIFTH SCHEDULE.**

---

UNOFFICIAL VERSION

UPDATED TO 31ST DECEMBER 2016

**SHIPPING (SMALL COMMERCIAL VESSELS)  
REGULATIONS**

13/2008.

*made under section 276*

**PART I  
GENERAL**

**1.** These Regulations may be cited as the Shipping (Small Commercial Vessels) Regulations. Citation.

**2.** In these Regulations— Interpretation.

“Act” means the Shipping Act;

“Boatmaster” or “master” includes any person having command or charge of any vessel other than a pilot;

“cargo ship” means a ship which is not a passenger ship or a fishing vessel;

“Certificate” means a Certificate of Inspection issued by the Director of Maritime Services;

“Code” means the Code of Safety for Small Commercial Vessels;

“commercial vessel” means a cargo or passenger ship;

“crew” includes seamen and apprentices;

“Director” means the Director of Maritime Services as referred to in section 403(2)(a) of the Act;

“Division” means the Division of Maritime Services established under section 403(1) of the Act;

“employer” means a person who employs a master to command a commercial vessel;

“existing licence” means a licence to operate a commercial vessel issued prior to the coming into force of these Regulations;

“foreign commercial vessel” means a cargo or passenger ship not registered or licensed in Trinidad and Tobago;

“Inspection” means an examination of a foreign commercial vessel whilst in Trinidad and Tobago waters;

“managing owner” includes any person not being an agent in whom an owner of such vessel has vested authority to manage and operate the vessel;

“Minister” means the Minister to whom the responsibility for shipping is assigned;

“new commercial vessel” means a vessel the keel of which was laid or the construction or lay-up was started on or after 31st January 2005;

“on duty” means, in the case of a master who has command of a commercial vessel—

(a) to his being on duty—

(i) for the purpose of having the command of the vessel to which these Regulations apply; or

(ii) for other purposes, in the course of his employment or in any other employment under his employer; or

(b) for the purpose of a trade or business carried on by him—

(i) to his having command of the vessel to which these Regulations apply for the purposes of that trade or business; or

(ii) being otherwise engaged in work for the purposes of trade or business, being work in connection with such a vessel or the passengers carried by it;

“owner” means—

(a) a demise or bare boat charterer; and

(b) a managing owner;

“passenger” means any person carried on board a ship, except—

(a) the master, a member of the crew or a person employed or engaged in any capacity on board the ship on the business of the ship;

(b) a child under one year of age; or

(c) a person carried on the ship under an obligation imposed upon the master to carry shipwrecked, distressed or other persons, or by reason of any circumstances which neither the master nor the owner nor the charterer, if any, could prevent or forestall;

“passenger ship” means a ship which is constructed or is habitually or on any particular occasion used, for carrying more than twelve passengers;

“Registrar” means the Registrar of Seamen referred to in section 403(2)(c) of the Act;

“seaman” includes every person employed or engaged in any capacity on board any ship, other than a master or a pilot or a person temporarily employed on the ship while in port and apprentices;

“STCW Convention” means the International Convention on Standards of Training, Certification and Watchkeeping, 1978;

“survey” means an examination of a commercial vessel registered in Trinidad and Tobago;

“voyage” includes an excursion; and

“working day” means any period during which a master is on duty which is not followed by an interval for rest of at least eight hours.

**3.** Subject to regulation 4, these Regulations shall apply to a commercial vessel registered in Trinidad and Tobago and a foreign commercial vessel when in Trinidad and Tobago waters—

- (a) of less than five hundred gross register tons;
- (b) between five and twenty-four metres in length; and
- (c) carrying not more than one hundred and fifty passengers or providing overnight accommodations.

**4.** (1) The Director may grant exemptions from all or any of the provisions of these Regulations, as may be specified in the exemption, for classes of commercial vessels or individual cases, subject to such conditions, as he may so specify.

(2) Any exemption given pursuant to these Regulations shall be in writing and shall specify the duration for which it is effective and the conditions, if any on which it is given.

Equivalent standards.

5. Where these Regulations require that a particular piece of equipment or machinery be carried in a commercial vessel or that any particular provisions as may be required by the Code shall be made, the Director may permit any other piece of equipment or machinery to be provided or carried, or any other provision to be made, where he is satisfied by trials thereof or otherwise that such other piece of equipment or machinery or provision is at least as effective as that required by these Regulations.

## PART II

### REQUIREMENTS FOR VESSELS

Vessels to be surveyed within one year.

6. Every commercial vessel to which these Regulations apply shall be surveyed or inspected for the issuance of a Certificate in accordance with regulation 8(2), not later than one year after these Regulations come into effect.

Application for Certificate.

7. (1) The owner of a commercial vessel shall make an application to the Director for a Certificate and such application shall be accompanied by the prescribed fee.

(2) Where an application made under subregulation (1) is in relation to a new commercial vessel, it shall be submitted prior to the start of the construction or conversion of the vessel.

(3) An initial Certificate shall be issued by the Director following a satisfactory survey or inspection for compliance with the Code.

First Schedule.

(4) The Certificate shall be in the form set out in the First Schedule and shall be valid from the date of initial inspection, for—

- (a) a period not exceeding one year, for passenger ships which undertake international voyages; and
- (b) a period not exceeding five years, for all other commercial vessels,

unless revoked by the Director.

**8.** (1) A survey or inspection shall be such as to ensure that the commercial vessel and its equipment are being maintained in accordance with the Code. Survey or inspection.

(2) An initial or renewal survey or inspection shall include a survey or inspection of—

- (a) the hull and related items on drydock;
- (b) structure;
- (c) machinery;
- (d) electrical equipment;
- (e) lifesaving equipment;
- (f) fire protection equipment;
- (g) pressure vessels and boilers;
- (h) steering systems;
- (i) other equipment and systems; and
- (j) sanitation and operational practices, including the competence and composition of the crew.

**9.** (1) The owner of a commercial vessel shall make an application to the Director for the renewal of a Certificate and such application shall be accompanied by the prescribed fee. Application for renewal of Certificate.

(2) A new Certificate may be issued by the Director following a satisfactory survey or inspection for compliance with the Code.

**10.** (1) A passenger ship which undertakes international voyages shall be surveyed or inspected annually, for the renewal of a Certificate. Interval for surveyor inspection for renewal of certificate.

(2) A commercial vessel other than that mentioned in subregulation (1) shall be surveyed or inspected—

- (a) at periodic intervals of not more than twelve months; and
- (b) every five years,

for the renewal of a Certificate.

LAWS OF TRINIDAD AND TOBAGO

MINISTRY OF THE ATTORNEY GENERAL AND LEGAL AFFAIRS

www.legalaffairs.gov.tt

928

Chap. 50:10

Shipping

[Subsidiary]

Shipping (Small Commercial Vessels) Regulations

(3) A survey or inspection under subregulation (1) shall be conducted within the three months prior to and the three months following the expiry of the Certificate and the new Certificate shall be effective from the anniversary date of the issuance of the previous Certificate.

(4) A survey or inspection under subregulation (2) shall be conducted within the three months prior to the expiry of the Certificate and the new Certificate shall be effective from the anniversary date of the issuance of the previous Certificate.

(5) Where the survey or inspection for the renewal of certificate under subregulation (1) or (2) is unsatisfactory, a re-survey or re-inspection may be conducted within three months of the unsatisfactory survey or inspection.

(6) Where a re-survey or re-inspection reveals compliance with the Code the new Certificate shall be issued and shall be effective from the anniversary date of the issuance of the previous certificate.

(7) The Director may, at any time where it is considered necessary, require a drydock survey or inspection to be carried out on a commercial vessel.

Loss of Certificate.

**11.** (1) Where the holder of a Certificate proves to the satisfaction of the Director that he has, without fault on his part, lost or been deprived of a Certificate already issued to him the Director shall, on receipt of the prescribed fee, cause a copy of the Certificate to be issued to the holder.

(2) Any copy issued under subregulation (1) shall be certified as a copy by the Registrar or such other person as the Director may authorise.

Suspension or cancellation of certificate of inspection.

**12.** (1) The Director may suspend or cancel a Certificate in any case where a vessel does not comply with the requirements of these Regulations or the Code.

UNOFFICIAL VERSION

UPDATED TO 31ST DECEMBER 2016

(2) Before a Certificate is suspended or cancelled under subregulation (1), the Director shall give notice to the owner or master of the vessel of the corrective measures to be taken within a specified time.

(3) Where the Director is satisfied that corrective action has been taken he shall not proceed with any further action.

(4) Where the owner or master fails to take the corrective measures required, the Director shall suspend or cancel the Certificate.

(5) Where the Director suspends or cancels the Certificate, the owner or master shall surrender the Certificate to the Director within seven days of the suspension or cancellation.

**13.** The owner or master of every commercial vessel shall ensure that—

Responsibilities of owner and master.

- (a) the safety equipment is maintained in compliance with the Code;
- (b) no change is made in the structural arrangements, machinery or other items on the vessel, after any survey or inspection required by these Regulations, without the approval of the Director; and
- (c) where an accident occurs to a commercial vessel or a deficiency is discovered which affects the safety of the vessel or the efficiency or completeness of its life saving appliances or other equipment, it is reported at the earliest opportunity to the Division, who shall determine if a survey or inspection is necessary.

**14.** A commercial vessel shall not proceed or attempt to proceed to sea unless—

Prohibition on proceeding to sea.

- (a) the owner or master possesses a valid Certificate;
- (b) the Certificate is displayed in some conspicuous place on board;

- (c) the vessel complies with the requirements of the Code, including any requirements as to operation, manning and maintenance and is operated in accordance with any conditions as specified in the Certificate.

## PART III

## BOATMASTERS AND BOAT ENGINEERS

Boatmaster and  
Boat Engineer.

**15.** (1) A commercial vessel shall carry in command a Boatmaster who possesses—

- (a) a licence issued by the Director under regulation 16, stating that the person is qualified to have command of such a vessel, where—
- (i) the licence is in force and is of a grade appropriate in respect to the waters in which the vessel is being navigated, the size of the vessel and the number of passengers carried; and
  - (ii) the vessel is in an area specified in the licence as one in which a vessel may be navigated under the command of the holder; or
- (b) a certificate of competency as a Deck officer issued in accordance with the provisions of the STCW Convention.

(2) A commercial vessel fitted with main propulsion machinery of up to 750KW shall, where an engineer is required by the Director, carry as Boat Engineer a person who possesses—

- (a) a licence issued by the Director under regulation 16 stating that the person is qualified to be in charge of the engines and machinery of such a vessel where—
- (i) the licence is in force and is of a grade appropriate in respect to the waters in which the vessel is being navigated; and
  - (ii) the vessel is in an area specified in the licence as one in which a vessel may be operated under the charge of the holder; or

(b) a certificate of competency as an engineer officer issued in accordance with the provisions of the STCW Convention.

(3) Where authorised by the Director, a commercial vessel fitted with main propulsion machinery above 750KW shall carry a Boat Engineer qualified in accordance with the STCW Convention.

**16.** (1) An application for a licence as Boatmaster or Boat Engineer shall be in such form as the Director may specify. Issue of licence.

(2) The Director shall, upon receipt of an application and any fee payable, issue a licence as Boatmaster or Boat Engineer where appropriate, to persons who meet the requirements of this regulation, in the form set out in the Second Schedule. Second Schedule.

(3) The following requirements shall be specified in sections IX/5 to IX/7 and IX/9 to IX/11 of the Code or from time to time by the Director in a Shipping Notice:

- (a) the standards of competence to be attained;
- (b) the conditions including conditions as to medical fitness and character;
- (c) any exceptions applicable with respect to the required standards or conditions;
- (d) the manner in which the attainment of any such standards or the satisfaction of any such conditions is to be evidenced; and
- (e) the conduct of any examinations and the conditions of admission to them.

(4) Examinations under subregulation (3)(e) shall be conducted by examiners appointed by the Minister.

**17.** (1) A licence as a Boatmaster issued under regulation 16 shall bear the title “Boatmaster Licence” and shall be of one of the following grades, which shall be stated in the licence: Grade and area restrictions of Boatmaster licence.

- (a) Boatmaster Licence Grade 1;
- (b) Boatmaster Licence Grade 2; or
- (c) Boatmaster Licence Grade 3.

LAWS OF TRINIDAD AND TOBAGO

MINISTRY OF THE ATTORNEY GENERAL AND LEGAL AFFAIRS

www.legalaffairs.gov.tt

932

Chap. 50:10

Shipping

[Subsidiary]

Shipping (Small Commercial Vessels) Regulations

Third Schedule. (2) The grade of licence appropriate in respect of a commercial vessel to which these Regulations apply shall be determined in accordance with the Third Schedule, or where the grade so specified is 2 or 3, a higher grade than that so specified.

(3) A Boatmaster licence of any grade shall be subject to such restriction as the Director may determine as to the area or areas in which a vessel may be navigated under the command of the holder and every such restriction shall be stated in the licence.

Grade and area restrictions of Boat Engineer licence.

18. (1) A licence as Boat Engineer issued under regulation 16 shall bear the title “Boat Engineer Licence” and shall be of one of the following grades, which shall be stated in the licence:

- (a) Boat Engineer Licence Grade 1; or
- (b) Boat Engineer Licence Grade 2.

Fourth Schedule.

(2) The grade of licence appropriate in respect of a commercial vessel to which these Regulations apply shall be determined in accordance with the Fourth Schedule, or where the grade so specified is 2, a higher grade than that so specified.

(3) A Boat Engineer licence of any grade shall be subject to such restriction as the Director may determine as to the area or areas in which a vessel may be operated under the charge of the holder and every such restriction shall be stated in the licence.

Renewal of licence.

19. (1) The Director shall on an application for renewal of a licence by the holder of an existing licence and on receipt of any fee payable renew a licence under these Regulations.

(2) The licence shall—

- (a) be of the grade which is appropriate in respect of—
  - (i) the waters in which the vessel is being navigated or operated; and
  - (ii) the size of vessel which in the period of twelve months before the coming into force of these Regulations was navigated or operated; and

UNOFFICIAL VERSION

UPDATED TO 31ST DECEMBER 2016

- (b) state the area or areas in which a vessel may be navigated or operated under the command or charge of the holder.

**20.** (1) A licence shall be renewed every three years for persons up to sixty-three years of age.

Intervals for renewal of licences.

(2) A renewal under subregulation (1) shall be subject to—

- (a) the holder providing proof that he has had at least forty-five days service in commercial vessels for which the licence is valid, during the previous three years; and
- (b) the submission of a valid medical fitness certificate issued in accordance with the Shipping (Medical Examination) Regulations.

Sub. Leg.

(3) A licence shall be renewed annually for persons over sixty-three years of age.

(4) A renewal under subregulation (3) shall be subject to—

- (a) the holder providing proof that he has had at least fifteen days service in a commercial vessel for which the licence is valid, during the previous year; and
- (b) the submission of a valid medical fitness certificate issued in accordance with the Shipping (Medical Examination) Regulations.

Sub. Leg.

(5) Where a person is unable to produce proof of the experience required under subregulation (2) or (4) that person shall apply for an examination.

(6) A licence issued under these Regulations shall remain valid only so long as the holder complies with the standards of competence and the conditions, including conditions as to medical fitness.

LAWS OF TRINIDAD AND TOBAGO

MINISTRY OF THE ATTORNEY GENERAL AND LEGAL AFFAIRS

www.legalaffairs.gov.tt

934

Chap. 50:10

Shipping

[Subsidiary]

Shipping (Small Commercial Vessels) Regulations

Record to be kept.

**21.** (1) The Registrar, or such other person authorised by the Director shall keep a copy of—

- (a) every licence issued under this Part;
- (b) every suspension, cancellation or alteration of and any other matter affecting such a licence,

in such manner as the Director may require.

Loss of licence.

**22.** (1) Where the Boatmaster or Boat Engineer proves to the satisfaction of the Director that he has, without fault on his part, lost or been deprived of a Boatmaster or Boat Engineer licence already issued to him, the Director shall, on receipt of any fee payable, cause a copy of the licence to be issued to the Boatmaster or Boat Engineer.

(2) Any copy issued under subregulation (1) shall be certified as a copy by the Registrar or such other person as the Director may authorise.

Suspension or cancellation of licence.

**23.** (1) Where it appears to the Director that a licensed Boatmaster or Boat Engineer is unfit to discharge his duties, whether by reason of incompetence or misconduct or for any other reason, he shall cause an inquiry to be held by one or more persons competent in the area and appointed by him.

(2) Where the inquiry recommends the suspension or cancellation of the licence, the Director shall give notice to the Boatmaster or Boat Engineer of the reasons for intended suspension or cancellation and the corrective measures to be taken within a specified time.

(3) Where corrective action has been taken, the Director shall not proceed with any further action.

(4) Where the Boatmaster or Boat Engineer fails to take the corrective measures required, the Director shall suspend or cancel the licence.

(5) Where a licence is suspended or cancelled, it shall be surrendered to the Director within seven days of the suspension or cancellation.

UNOFFICIAL VERSION

UPDATED TO 31ST DECEMBER 2016

**PART IV**

**HOURS OF WORK**

**24.** (1) It shall be the duty of the owner of a commercial vessel to ensure, so far as is reasonably practicable, that the master and seamen do not work more hours than is stipulated.

Duty of owner, master, seamen.

(2) It shall be the duty of every master of a commercial vessel to ensure, so far as is reasonably practicable that seamen do not work more hours than is stipulated.

(3) Every master and seaman, so far as reasonably practicable, shall ensure that he is properly rested when commencing duty on a commercial vessel.

**25.** (1) This regulation applies to commercial vessels which complete a voyage in excess of twenty-four hours.

Hours of rest on voyages which exceed 24 hours.

(2) The hours of rest shall not be less than ten hours in every twenty-four-hour period, which may be divided into no more than two periods, one of which shall be at least six hours in length.

(3) The minimum period of ten hours may be reduced to a minimum of six consecutive hours on condition that such reduction shall not extend beyond two days, and not less than seventy hours of rest are provided in each seven-day period.

(4) Notwithstanding subregulations (2) and (3), the stipulated hours of rest need not be maintained in cases of emergency, including giving assistance to other vessels, person in distress at sea, a drill or any overriding operational conditions.

**26.** (1) This regulation applies to commercial vessels which complete a voyage within twenty-four hours.

Working hours of a master on voyages of less than 24 hours.

(2) The working day of a master shall not exceed sixteen hours.

(3) On any working day a master shall not be on duty on a commercial vessel for a period exceeding more than ten hours in aggregate.

LAWS OF TRINIDAD AND TOBAGO

MINISTRY OF THE ATTORNEY GENERAL AND LEGAL AFFAIRS

www.legalaffairs.gov.tt

936

Chap. 50:10

Shipping

[Subsidiary]

Shipping (Small Commercial Vessels) Regulations

(4) Where on any working day a master has been on duty—

- (a) for a period of six hours and the end of that period does not mark the end of his working day; or
- (b) for periods amounting in the aggregate to six hours and there has not been between any of those periods an interval of at least thirty minutes in which the master was able to obtain rest and refreshment and the end of the last of those periods does not mark the end of the working day,

there shall be an interval of rest of at least thirty minutes at the end of that period or at the end of the last of those periods.

(5) Between any two successive working days of a master, there shall be an interval of at least eight hours during which he may obtain rest and refreshment.

(6) For the purposes of subregulation (5), where a master has command of a vessel in the course of his employment, a period of time shall not be treated as if it is not an interval for rest by reason only that the master may be called upon to report for duty if required.

(7) Notwithstanding subregulations (4) and (5) the rest periods specified need not be maintained in cases of any emergency including giving assistance to other vessels, person in distress at sea, or drill or any overriding operational conditions.

(8) Where the Director considers that it would be appropriate to grant an exemption from all or any of the requirements of subregulation (2) to (6) he may on such terms, if any, as may be specified grant such an exemption; and, subject to giving reasonable notice, the Director may alter or cancel an exemption so granted.

Contravention of regulation 26.

**27.** (1) Subject to subregulation (2) where any of the requirements of regulation 26 is contravened by a master, he and

UNOFFICIAL VERSION

UPDATED TO 31ST DECEMBER 2016

where applicable, his employer or a person to whose orders the master was subject, who caused or permitted the contravention, commits an offence.

(2) A person shall not be liable under this regulation where he can prove—

- (a) that the contravention was due to an unavoidable delay in the completion of a voyage arising out of circumstances which he could not reasonably have foreseen; or
- (b) in the case of a person other than the master, that the contravention was due to the fact that the master for any particular period or periods had conned a vessel or vessels or had been on duty—
  - (i) otherwise than in the employment of the person charged; or,
  - (ii) otherwise than in the employment in which he was subject to the orders of the person charged,

and that the person charged was not, and could not reasonably have become, aware of that fact.

#### PART V

#### MANNING AND TRAINING

**28.** A commercial vessel shall not proceed on a voyage unless the manning of the vessel is in accordance with the Certificate or is approved by the Director in accordance with section IX/17 of the Code. Manning.

- 29.** The owner of a passenger ship shall— Training in emergency procedures.
- (a) establish procedures to be taken by the master and crew during an emergency, to assist passengers and to deal with the emergency in general; and
  - (b) ensure that the master and crew have received on-board training in the procedures to be observed in the event of an emergency.

**LAWS OF TRINIDAD AND TOBAGO**

MINISTRY OF THE ATTORNEY GENERAL AND LEGAL AFFAIRS

www.legalaffairs.gov.tt

938

**Chap. 50:10**

*Shipping*

[Subsidiary]

*Shipping (Small Commercial Vessels) Regulations*

**PART VI**

**MISCELLANEOUS**

Penalties.

**30.** (1) Any owner and the master who contravenes any provision of Part II or III or regulation 27 of these Regulations is guilty of an offence and is liable on summary conviction to a fine of thirty thousand dollars and to imprisonment for six months.

(2) Any person who contravenes any provision of Part IV or regulation 28 of these Regulations is guilty of an offence and is liable on summary conviction to a fine of twelve thousand dollars.

(3) In any proceedings for an offence under these Regulations it shall be a defence for the person charged to prove that he took all reasonable steps to avoid the commission of the offence.

Power to detain.

**31.** In any case where a commercial vessel does not comply with the requirements of these Regulations, that vessel may be detained and section 316 of the Act shall apply to the detention.

Prescribed fees.  
Fifth Schedule.

**32.** The fees prescribed in the Fifth Schedule shall be paid in respect of certificates, licences, documents and examinations specified therein.

---

UNOFFICIAL VERSION

UPDATED TO 31ST DECEMBER 2016

FIRST SCHEDULE

Regulation 7  
(4).

FORM OF CERTIFICATE OF INSPECTION

 The Republic of Trinidad and Tobago Maritime Services Division <b>CERTIFICATE OF INSPECTION</b>				Certificate Date:	
				Expiration Date:	
VESSEL NAME	IDENTITY MARK	CALL SIGN	SERVICE		
PORT OF REGISTRY	HULL MATERIAL	POWER	PROPULSION		
PLACE BUILT	DATE BUILT	GROSS TONNAGE	NET TONNAGE	LENGTH	
OWNER	OPERATOR				
THIS VESSEL SHALL BE MANNED WITH THE FOLLOWING PERSONNEL: — MASTER, BOATMASTER GRADE — DECK RATINGS CATEGORY 1 — MATE, BOATMASTER GRADE — DECK RATINGS CATEGORY 2 — BOAT ENGINEER GRADE 1 — DECK RATINGS CATEGORY 3 — BOAT ENGINEER GRADE 2 — DECK RATINGS CATEGORY 4					
IN ADDITION, THIS VESSEL MAY CARRY ..... PASSENGERS; ..... OTHER PERSONS IN CREW; ..... PERSONS IN ADDITION TO CREW; AND ..... TOTAL PERSONS ALLOWED:					
OPERATING AREA AND CONDITIONS OF OPERATION   WITH THIS INSPECTION HAVING BEEN COMPLETED AT ..... ON ....., THIS VESSEL IS CERTIFIED BY ..... TO BE IN ALL RESPECTS IN CONFORMITY WITH THE APPLICABLE VESSEL INSPECTION LEGISLATION.					
ANNUAL INSPECTIONS			THIS CERTIFICATE ISSUED BY:		
			_____ (AUTHORISED OFFICIAL)		
			_____ DIRECTOR OF MARITIME SERVICES (REGISTRAR OF SHIPS)		
DATE	PLACE	SIGNATURE			



 <p>The Republic of Trinidad and Tobago                  Maritime Services Division</p> <p><b>CERTIFICATE OF INSPECTION</b></p>																																																														
VESSEL NAME	IDENTITY MARK	CERTIFICATION DATE	PAGE																																																											
<table style="width: 100%; border-collapse: collapse;"> <tr> <td colspan="2" style="text-align: center;">LIFESAVING EQUIPMENT</td> <td style="text-align: right;">REQUIRED</td> </tr> <tr> <td style="width: 30%;"></td> <td style="width: 10%; text-align: center;">NUMBER</td> <td style="width: 10%; text-align: center;">PERSONS</td> <td style="width: 50%;"></td> </tr> <tr> <td>TOTAL EQUIPMENT FOR LIFEBOATS (TOTAL)</td> <td></td> <td></td> <td>LIFE PRESERVERS (ADULT)</td> </tr> <tr> <td>    LIFEBOATS (PORT)*</td> <td></td> <td></td> <td>LIFE PRESERVERS (CHILD)</td> </tr> <tr> <td>    LIFEBOATS (STARBOARD)*</td> <td></td> <td></td> <td>LIFE BUOYS (TOTAL)</td> </tr> <tr> <td>    MOTOR LIFEBOATS*</td> <td></td> <td></td> <td>    WITH LIGHTS*</td> </tr> <tr> <td>    LIFEBOATS W/RADIO*</td> <td></td> <td></td> <td>    WITH LINE ATTACHED*</td> </tr> <tr> <td>RESCUE BOATS/PLATFORMS</td> <td></td> <td></td> <td>    OTHER*</td> </tr> <tr> <td>INFLATABLE RAFTS</td> <td></td> <td></td> <td>IMMERSION SUITS</td> </tr> <tr> <td>LIFEFLOATS/BUOYANT APPARATUS</td> <td></td> <td></td> <td>PORTABLE LIFEBOAT RADIOS</td> </tr> <tr> <td>WORKBOATS (NOT REQUIRED)</td> <td></td> <td></td> <td>EQUIPPED WITH EPIRB?</td> </tr> <tr> <td></td> <td></td> <td></td> <td>(*INCLUDED IN TOTALS)</td> </tr> <tr> <td colspan="4" style="text-align: center;">FIRE FIGHTING EQUIPMENT</td> </tr> <tr> <td>TOTAL HOSE LENGTH</td> <td></td> <td>NUMBER OF FIRE AXES</td> <td>NUMBER OF FIRE PUMPS</td> </tr> <tr> <td colspan="4" style="text-align: center;">FIXED EXTINGUISHING SYSTEMS</td> </tr> </table>				LIFESAVING EQUIPMENT		REQUIRED		NUMBER	PERSONS		TOTAL EQUIPMENT FOR LIFEBOATS (TOTAL)			LIFE PRESERVERS (ADULT)	LIFEBOATS (PORT)*			LIFE PRESERVERS (CHILD)	LIFEBOATS (STARBOARD)*			LIFE BUOYS (TOTAL)	MOTOR LIFEBOATS*			WITH LIGHTS*	LIFEBOATS W/RADIO*			WITH LINE ATTACHED*	RESCUE BOATS/PLATFORMS			OTHER*	INFLATABLE RAFTS			IMMERSION SUITS	LIFEFLOATS/BUOYANT APPARATUS			PORTABLE LIFEBOAT RADIOS	WORKBOATS (NOT REQUIRED)			EQUIPPED WITH EPIRB?				(*INCLUDED IN TOTALS)	FIRE FIGHTING EQUIPMENT				TOTAL HOSE LENGTH		NUMBER OF FIRE AXES	NUMBER OF FIRE PUMPS	FIXED EXTINGUISHING SYSTEMS			
LIFESAVING EQUIPMENT		REQUIRED																																																												
	NUMBER	PERSONS																																																												
TOTAL EQUIPMENT FOR LIFEBOATS (TOTAL)			LIFE PRESERVERS (ADULT)																																																											
LIFEBOATS (PORT)*			LIFE PRESERVERS (CHILD)																																																											
LIFEBOATS (STARBOARD)*			LIFE BUOYS (TOTAL)																																																											
MOTOR LIFEBOATS*			WITH LIGHTS*																																																											
LIFEBOATS W/RADIO*			WITH LINE ATTACHED*																																																											
RESCUE BOATS/PLATFORMS			OTHER*																																																											
INFLATABLE RAFTS			IMMERSION SUITS																																																											
LIFEFLOATS/BUOYANT APPARATUS			PORTABLE LIFEBOAT RADIOS																																																											
WORKBOATS (NOT REQUIRED)			EQUIPPED WITH EPIRB?																																																											
			(*INCLUDED IN TOTALS)																																																											
FIRE FIGHTING EQUIPMENT																																																														
TOTAL HOSE LENGTH		NUMBER OF FIRE AXES	NUMBER OF FIRE PUMPS																																																											
FIXED EXTINGUISHING SYSTEMS																																																														
SPACE PROTECTED	AGENT	CAPACITY																																																												
FIRE EXTINGUISHERS — HAND, PORTABLE AND SEMI-PORTABLE  EXEMPTIONS																																																														

Regulation  
16(2).

SECOND SCHEDULE

FORM A



Republic of Trinidad and Tobago

BOATMASTER LICENCE GRADE 1/2/3

Issued by the  
MARITIME SERVICES DIVISION  
under the provisions of the  
Code of Safety for Small Commercial Vessels

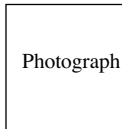

No. ....

This is to certify that .....  
is entitled to service in a capacity requiring a Boatmaster Grade 1/2/3 in commercial vessels of ..... metres  
in length operating in *Protected/Coastal/Exposed* waters.

The holder is further entitled to serve in such other vessels and in such areas as may be endorsed on this certificate.  
ENDORSEMENT:

Date of Issue:

Date of Expiry:

.....  
*Signature of Holder*

OFFICIAL  
STAMP

.....  
*Director of Maritime Services*

This Licence is valid only if the holder is in possession of a valid Medical Fitness Certificate.

**FORM B**



Republic of Trinidad and Tobago

**BOATMASTER LICENCE GRADE 1/2**

Issued by the  
MARITIME SERVICES DIVISION  
under the provisions of the  
Code of Safety for Small Commercial Vessels

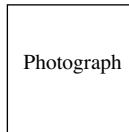

No. ....

This is to certify that .....  
is entitled to service in a capacity requiring a Boatmaster Engineer Grade 1/2 in commercial vessels with an installed power of less than 750 kW operating in *Coastal/Exposed* waters.

The holder is further entitled to serve in such other vessels and in such areas as may be endorsed on this certificate.  
ENDORSEMENT:

Date of Issue:

Date of Expiry:

.....  
*Signature of Holder*

OFFICIAL  
STAMP

.....  
*Director of Maritime Services*

This Licence is valid only if the holder is in possession of a valid Medical Fitness Certificate.

\_\_\_\_\_

**LAWS OF TRINIDAD AND TOBAGO**

MINISTRY OF THE ATTORNEY GENERAL AND LEGAL AFFAIRS

www.legalaffairs.gov.tt

944

**Chap. 50:10**

*Shipping*

**[Subsidiary]**

*Shipping (Small Commercial Vessels) Regulations*

Regulation 17  
(2).

**THIRD SCHEDULE**

Waters	Size and Type of Vessel	Minimum Grade of Licence
Protected	Open Boat < 24m	3
		2
Coastal	Open Boat <12m passenger <24m other than passenger 12–24m passenger	3
		2
		2
		1
Exposed	All vessels	1

(1) Where a vessel (the master of which is required to hold a Grade 2 licence) is to be operated more than twenty miles from a safe haven, a navigation endorsement is required. The syllabus is a practical test in chartwork and electronic aids to navigation.

(2) Where a vessel (the master of which is required to hold a licence) has sails as its principal means of propulsion a sail endorsement is required. The requirement for a sail endorsement is a practical test on boat handling as detailed in Annex 11-1.1. of the Code.

---

**FOURTH SCHEDULE**

Waters	Size of Vessel	Minimum Grade of Licence
Protected	< 24m	2
Coastal	15–24m	2
Exposed	< 24m	1

A person required to hold a Boat Engineer Licence on a passenger vessel must also have completed six months service whilst holding the appropriate certificate.

---

UNOFFICIAL VERSION

UPDATED TO 31ST DECEMBER 2016

**FIFTH SCHEDULE**

Regulation 32.

**SCHEDULE OF FEES**

(Trinidad and Tobago Dollars)

The applicant shall pay the following fees for services and documents:

Initial application fee <i>re</i> : vessel survey/inspection ... ..	\$ 1,000.00
Renewal application fee <i>re</i> : vessel survey/inspection ... ..	\$ 800.00
Vessel <i>re</i> : survey/re-inspection ... ..	\$ 500.00
Initial or renewal Certificate of Inspection ... ..	\$ 1,000.00
Replacement of lost Certificate of Inspection ... ..	\$ 1,000.00
Application fee <i>re</i> : initial/renewal licence as Boatmaster/Boat Engineer ...	\$ 500.00
Processing fee <i>re</i> : application for Boatmaster/Boat Engineer Licence ...	\$ 200.00
Examination fee for Boatmaster/Boat Engineer Licence ... ..	\$ 300.00
Replacement of lost Boatmaster/Boat Engineer Licence ... ..	\$ 500.00